



TMH 



Catalogue

LIGHTS & BULBS



-  Most articles stated in this catalogue are available from stock, unless they were sold out after the publication of this catalogue. Contact us if you require a similar article that is not shown in this catalogue: alternatives might be available. TVH is a supplier of spare parts and accessories suitable for OEM-equipment. OEM-references and makes are purely indicative and do not imply that the accessories and/or spare parts originate from the original equipment or parts manufacturer. Please consult our general terms and conditions of sale on www.tvh.com/avv.
- 
 De meeste in deze catalogus vermelde artikelen zijn uit voorraad leverbaar, tenzij ze na publicatie van deze catalogus uitverkocht werden. Contacteer ons indien u een gelijkaardig artikel wenst dat niet in deze catalogus is opgenomen: het is mogelijk dat wij ook dit kunnen leveren. TVH is een leverancier van reserveonderdelen en accessoires geschikt voor OEM-uitrusting. OEM-referenties en merken zijn enkel indicatief en betekenen niet dat de accessoires en/of onderdelen afkomstig zijn van de originele toestel- of onderdelenfabrikant. Gelieve onze algemene verkoopsvoorwaarden te consulteren op www.tvh.com/avv.
-  La plupart des articles mentionnés dans ce catalogue sont disponibles sauf si épuisement du stock à la publication de ce catalogue. Contactez-nous si vous souhaitez un article similaire qui n'est pas repris dans ce catalogue : il est possible que nous pouvons vous le fournir. TVH est un fournisseur de pièces détachées et d'accessoires adaptables sur des marques constructeurs. Les références et marques constructeurs sont uniquement indicatives et n'impliquent pas que les accessoires et/ou pièces proviennent du fabricant de la machine ou de la pièce d'origine. Veuillez consulter nos conditions générales de vente sur www.tvh.com/avv.
-  Die in dieser Liste aufgeführten Artikel sind in der Regel ab Lager lieferbar es sei denn, sie sind nach der Veröffentlichung des vorliegenden Katalogs ausverkauft. Kontaktieren Sie uns wenn Sie einen ähnlichen Artikel benötigen dieser aber nicht im Katalog enthalten ist: Alternativen könnten verfügbar sein. TVH ist Lieferant von Ersatzteilen und Zubehör die für die OEM – Ausstattung geeignet sind. OEM-Referenzen und Marken sind rein Indikativ und bedeuten nicht, dass das Zubehör und/oder Ersatzteile vom Originalgeräte- oder Ersatzteilhersteller sind. Druckfehler vorbehalten. Alle Verkäufe unterliegen den allgemeinen Geschäftsbedingungen www.tvh.com/avv.
-  La mayoría de los artículos que figuran en este catálogo se encuentran en stock, a menos que tras la publicación de este catálogo se hayan agotado. Contacte con nosotros si desea un artículo similar que no se halle en este catálogo : es posible que podamos ofrecerle aquel que usted necesita. TVH es un proveedor de recambios y accesorios adecuados para equipos OEM. Las referencias y marcas OEM mencionadas son meramente indicativas y no implican que los accesorios y / o recambios procedan del fabricante de maquinaria o recambios original. Por favor, consulte nuestras condiciones de venta en www.tvh.com/avv.
-  La maggior parte dei ricambi elencati in questo catalogo sono a stock, a meno che dopo la pubblicazione di questo catalogo sono stati venduti. Contattecì se desiderate un articolo simile che non è riportato in questo catalogo: è possibile che possiamo offrire anche questi. TVH è un fornitore di pezzi di ricambio e accessori per OEM, riferimenti OEM e marche sono solo indicativi e non implicano che gli accessori e/o di componenti derivino dal costruttore originale o dal produttore del componente. Si prega di consultare i nostri termini di vendita su www.tvh.com/avv.
-  Części z tego katalogu są zazwyczaj na stanie magazynowym. Również części które nie są wyszczególnione w katalogu mogą być dostarczone na zamówienie w najkrótszym możliwym terminie. Opis części O.E.M. jest używany informacyjnie i nie wskazuje na to, że dany produkt jest wyprodukowany przez podanego producenta. Zawartość katalogu może ulec zmianie bez wcześniejszego informowania o tym. Wszystkie użyte zdjęcia, rysunki, nazwy marek, opis i numery służą tylko do identyfikacji.
-  Запчасти из настоящего списка, как правило, имеются в запасе, если только он не распродан. Прочие, не фигурирующие в списке артикулы, могут быть поставлены в самые кратчайшие сроки. Указание оригинальных номеров производителя не предполагает обязательного оригинального происхождения самих деталей. Данный список может изменяться без предварительного уведомления. Все использованные фото, рисунки, иллюстрации, названия брендов, наименования и номера служат исключительно для цели идентификации.





passionate people
clear communication **happy customers**
smart solutions excellent experiences
strong ambitions

Dear customer,

In 1969 Paul Thermote & Paul Vanhalst began servicing and selling agricultural machinery, construction machinery and forklift trucks. Today, TVH is one of the most respected names in the material handling industry. Over the past 48 years we have grown from 2 founders to more than 6000 employees with offices and distribution facilities on every continent.

We are committed to being the worldwide leading supplier of quality parts and accessories for the material handling, industrial and agricultural equipment industry. While we take pride in our quality products, we know that without our customers, we would not exist. We are continually striving to increase our product range and to improve our services in order to be the true one-stop shop for our valued customers.

We are looking forward to working with you.

The Thermote & Vanhalst families



Watch our
company movie.



HOW CAN WE SERVE YOU?



TVH PARTS

ALL PARTS, ALL MAKES



Computer-controlled stock management
> 500 000 m² of warehousing



One-stop shop
> 680 000 stock items



Webshop & online support
> 30 000 000 known references



Technically-skilled employees
Assistance in 37 languages
64 nationalities



52 parts branches worldwide
Happy customers in over 170 countries
Same-day shipment, next-day delivery



QUALITY IS OUR PRIORITY

Is quality also a priority in your business? Rely on TVH as your partner.

In-depth product knowledge and specific testing equipment allows us to continuously improve processes and quality standards.



TVH

STRONG BRANDS, GUARANTEED QUALITY

Reliable products and services contribute to the day-to-day success of your company. That's why we choose top quality brands for our maintenance, repair and operation products, just like you do.

In addition to those, our strong housebrands guarantee an excellent range and quality standard for our mechanical and hydraulic attachments, internal transport equipment, battery chargers and accessories.



TOTALSOURCE[®]

ENERGIC Plus[®]

cam[®]
s y s t e m
LIFT TRUCK ATTACHMENTS

TOTALLIFTER[®]

Climax[®]



WHAT CAN YOU EXPECT MORE?

Our offer of **reconditioned parts** is unique in the market. Our technicians follow the strictest quality procedures to finalise the reconditioning. After extensive testing, the parts are then placed in stock.

We also repair **electronic parts** in our high-tech electronic department. Our range includes printed circuit boards, electronic speed controllers, displays, chargers, contactors, joysticks, accelerators and directional switches.

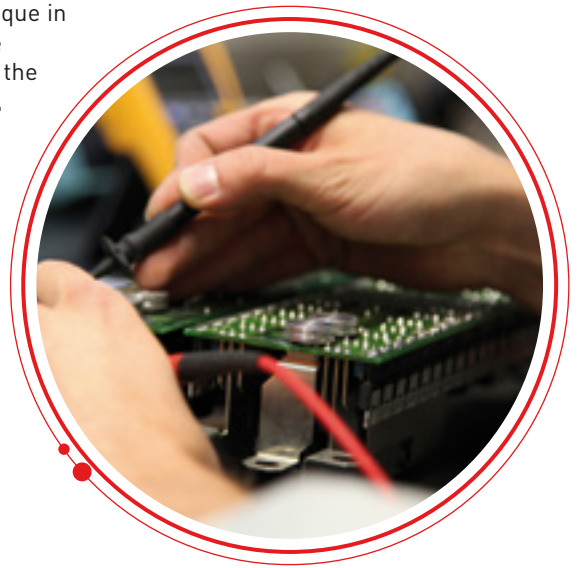

Discover our outlet store with new and second-hand products at rock-bottom prices.

Go to www.tvh.com/tvhbay



Visit our webshop whenever and wherever you want.

Request your login details now and benefit from the many advantages offered in MyTotalSource!



Discover the possibilities of the **MyTotalSource app**.

The MyTotalSource app offers you the possibility to request offers, place orders and scan bar codes of references from your smartphone.

For any questions, call or mail our help desk for free support:

T +32 56 43 48 66
ecommerce@tvh.com

www.tvh.com

TVHEQUIPMENT

SECOND-HAND EQUIPMENT & ELECTRIC WAREHOUSING



- 600 lift trucks in stock
- 300 aerial work platforms
- Telehandlers and all-terrain trucks
- Masts and attachments

Go to myequipmentfinder.tvh.com





CATALOGUES

Our catalogues give you information about the product groups, brands and makes in our range. The extensive and detailed information contains general product info, pictures and/or dimensions.

- REF 21713862 Consumables & accessories
- REF 29193029 Attachments & handling equipment
- REF 25564923 Batteries, chargers & accessories
- REF 20177702 Brushes
- REF 37474860 Chains & accessories
- REF 10185471 Contactors & contacts
- REF 21178582 Electronic accessories
- REF 31072159 Energic Plus
- REF 34167446 Engine parts
- REF 10727802 Exhaust systems
- REF 33113100 Fluke
- REF 20177906 Fuses & fuse holders
- REF 29127398 Grammer seats
- REF 31331437 Hydraulic parts & accessories
- REF 19949421 Key switches
- REF 12594102 Labels & decals
- REF 31072165 Lights & bulbs
- REF 22802499 LPG system parts
- REF 7872482 Mast rollers
- REF 26501928 Paint & accessories
- REF 31072162 Pallet truck parts
- REF 7835233 Potentiometers & encoders
- REF 7083552 Relays
- REF 12726578 Replacement parts for Genie
- REF 15069637 Replacement parts for Haulotte
- REF 12613028 Replacement parts for JLG
- REF 20769251 Replacement parts for scrubbers & sweepers
- REF 24154086 Replacement parts for tail lifts
- REF 27506014 Seats & accessories
- REF 6252659 Starters & alternators
- REF 34744204 Tracks & undercarriage parts
- REF 24337660 Tyres, rims & accessories
- REF 7072186 Wheel brake & master cylinders
- REF 31072155 Wheels, rollers & castors
- REF 34609026 Windshields & glazing
- Range of filters available in MyProductSearch & MyPartsFinder

PRODUCT SPECIALS

We gladly keep you informed of our extensive product range. In addition to our catalogues we present you our 'product specials': useful brochures that will guide you within specific product categories.



- REF 31346611 Air conditioning
- REF 14372877 Document & accessories holders
- REF 21735662 Drum handling & accessories
- REF 31642339 Electronic accessories
- REF 22835159 Force professional tools
- REF 38742387 Forks & accessories
- REF 21720627 Hardware special
- REF 21713854 Hydraulic power units
- REF 18178749 Jacks & supports
- REF 22775197 LED lights
- REF 38088053 LED lights & consumables for trailer-mounted equipment
- REF 21841408 Lubrication & accessories
- REF 20778928 Mirrors
- REF 37575584 Personal care & cleaning products
- REF 17868205 Press special
- REF 28975226 Safety equipment for aerial work platforms
- REF 31773321 Safety products
- REF 20963014 Skips, scoops & crane jibs
- REF 33349886 Stainless steel handling products
- REF 36108454 Summertime products
- REF 19550195 Twistlocks special
- REF 33825047 Winter products



About TVH	I	Over TVH	I
Nice to know	1	Goed om te weten	1
Interior lights	9	Interieurverlichting	9
Front lights	15	Voorlichten	15
Indicator lights	31	Knipperlichten	31
Rotating/flashing beacons	45	Zwaaï-/flitslichten	45
Rear lights	89	Achterlichten	89
Reflectors	135	Reflectoren	135
Marker lights	149	Markeringslichten	149
License plate lights	159	Nummerplaatverlichting	159
Safety lights	163	Veiligheidslichten	163
Work lights	169	Werklichten	169
Portable lights	195	Draagbare verlichting	195
Premium bulbs	203	Premium lampen	203
Flashtubes	213	Flitsbuizen	213
Incandescent bulbs	219	Gloeilampen	219
Halogen bulbs	245	Halogeenlampen	245
Fluorescent bulbs	255	Fluorescentielampen	255
High intensity discharge bulbs	259	Hogedruk gasontladingslampen	259
Spare kits/dashboard bulbs	263	Reservesets/dashboardlampen	263
Maintenance, repair & operation	273	Onderhoud & reparatie	273



À propos de TVH	I
Bon à savoir	1
Éclairage intérieur	9
Phares avant	15
Feux clignotants	31
Gyrophares / feux à éclats	45
Feux arrière	89
Catadioptrés	135
Feux d'encombrement	149
Feux de plaque d'immatriculation	159
Avertisseurs lumineux	163
Lampes de travail	169
Lampes portables	195
Ampoules premium	203
Tubes-éclairs	213
Lampes à incandescence	219
Ampoules halogènes	245
Lampes fluorescentes	255
Lampes à décharge haute intensité	259
Kits de pièces détachées / ampoules pour tableau de bord	263
Maintenance, réparation & opération	273

Über TVH	I
Gut zu wissen	1
Innenleuchten	9
Frontleuchten	15
Kontrollleuchten	31
Rundum-/Blitzleuchten	45
Rückleuchten	89
Reflektoren	135
Markierungsleuchten	149
Kennzeichenleuchten	159
Sicherheitsleuchten	163
Arbeitsleuchten	169
Handleuchten	195
Premium-Glühlampen	203
Blitzröhre	213
Glühlampen	219
Halogenlampen	245
Fluoreszierende Lampen	255
Hochdruckentladungslampen	259
Ersatzteilsätze/ Lampen für Armaturenbretter	263
Wartung, Reparatur & Instandhaltung	273



Sobre TVH	I
Es bueno saber	1
Luces para la cabina	9
Luces frontales	15
Luces indicadoras	31
Intermitentes	45
Faros traseros	89
Reflectores	135
Luces de gálibo	149
Luces para matrícula	159
Luces de seguridad	163
Faros de trabajo	169
Luces portátiles	195
Lámparas premium	203
Tubos de flash	213
Lámparas incandescentes	219
Lámparas halógenas	245
Lámparas fluorescentes	255
Lámparas de descarga de alta intensidad	259
Kit de repuestos/ lámparas tablero de mandos	263
Mantenimiento, reparación & operaciones	273

Sobre a TVH	I
Bom saber	1
Luces interiores	9
Faróis da frente	15
Luces indicadoras	31
Faróis rotativos/de flash	45
Faróis traseiros	89
Refletores	135
Luces de marcação	149
Luz de chapa de matrícula	159
Luces de segurança	163
Faróis de trabalho	169
Faróis portáteis	195
Lâmpadas premium	203
Tubos de flash	213
Lâmpadas incandescentes	219
Lâmpadas halogénio	245
Lâmpadas fluorescentes	255
Lâmpadas de descarga de alta intensidade	259
Kits de reposição/lâmpadas de painel	263
Manutenção, reparação & operação	273



Circa TVH	I	O TVH	I
Utile da sapere	1	Dobrze wiedzieć	1
illuminazione interna	9	Światła wewnętrzne	9
Luci frontali	15	Światła przednie	15
Indicatori di direzione	31	Kierunkowskazy	31
Fari rotanti/lampeggianti	45	Światła rotacyjne/migające	45
Fari posteriori	89	Światła tylne	89
Catarifrangenti	135	Reflektory	135
Luci di segnalazione	149	Światła ostrzegawcze	149
Luci targa	159	Światło do podświetlania tablic rejestracyjnych	159
Luci di sicurezza	163	Światła awaryjne	163
Fari da lavoro	169	Światła robocze	169
Luci portatili	195	Przenośne światła	195
Lampadine premium	203	Żarówki Premium	203
Stroboscopi	213	Lampy błyskowe	213
Lampadine a incandescenza	219	Żarówki	219
Lampade alogene	245	Żarówki halogenowe	245
Lampade fluorescenti	255	Żarówki fluorescencyjne	255
Lampade a scarica ad alta intensità	259	Żarówki wyładowcze dużej intensywności	259
Kits di ricambi/lampade cruscotto	263	Zestawy/Żarówki do deski rozdzielczej	263
Manutenzione, riparazione & operazione	273	Konserwacja, naprawa i działanie	273



Кратко о TVH	I
Полезно знать	1
Внутреннее освещение	9
Передние фары	15
Световые индикаторы	31
Вращающиеся/проблесковые маячки	45
Задние фары	89
Отражатели	135
Маркировочная сигнализация	149
Подсветка для лицензионного номера	159
Контрольные лампы безопасности	163
Рабочее освещение	169
Переносные фонари	195
Лампочки высокого качества	203
Импульсные лампы	213
Лампы накаливания	219
Галогенные лампы	245
Люминесцентные лампы	255
Лампы с разрядом высокой интенсивности	259
Комплекты/лампы приборной панели	263
Техническое обслуживание, ремонт и эксплуатация	273



NOTES

A series of horizontal dotted lines for writing notes.



NICE TO KNOW



NICE TO KNOW – GENERAL

Structure of the catalogue

The lights in this catalogue were split up according to the type (interior lighting, indicator lights, rotating beacons ...). The classification of these different types occurs according to the following criteria:

- Shape (round, rectangular or special shapes)
- Technology (LED, xenon, halogen or incandescent bulb)
- Dimensions

The chapter 'Work lights' is an exception to this classification. In this chapter all LED work lights have been classified according to the Lumen.

The lights that are suitable for use on public roads are marked with the marking 'E-approved'.

Some of the lights have a different design because they are only used at the left- or right-hand side of the machine. This is indicated by LH (left-hand side) and RH (right-hand side).

It's important what side is indicated with LH and RH. The drawing on the right can help you.

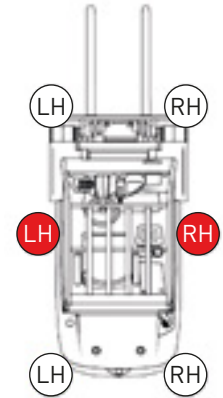

IP-ratings

IP ratings in general specify the protection of enclosures of electronic equipment from dust, solid objects and fluids. The first number refers to the protection against dust and solid objects. The second number refers to the protection against fluids and moisture.

Protection against solid objects and dust			
First Number	Description/Test	Second Number	Description/Test
X	Not tested	X	Not tested
0	No protection	0	No protection
1	Protection against solid objects over 50 mm, e.g. accidental touch by hands	1	Protection against vertically falling drops of water
2	Protection against solid objects over 12 mm, e.g. fingers	2	Protection against direct sprays of water up to 15 degrees
3	Protection against solid objects over 2,5 mm (tools/wires)	3	Protection against sprays to 60 degrees
4	Protection against solid objects over 1 mm (tools/wires/small wires)	4	Protection against water sprayed from all directions – limited ingress permitted
5	Protection against dust – limited ingress (no harmful deposit)	5	Protection against low-pressure jets of water from all directions – limited ingress permitted
6	Total protection against dust	6	Protection against strong jets of water, e.g. for use on ship decks – limited ingress permitted
		7	Protection against the effects of immersion between 15 cm and 1 m
		8	Protection against long periods of immersion under pressure

Remark: There are IP values which are followed by the character 'K', e.g. IP5K4K

The K indicates that the light has been tested with an increased pressure and will not have any damaging effects.

Using the previous example IP5K4K, this IP value indicates that dust parts can only enter in a very small degree so that the operation or safety is guaranteed. Water sprayed from all directions under increased pressure won't have a damaging effect on the housing. The water pressure will be around 4 bar.

IP6K4K indicates there is no dust allowed to enter. The protection against water is the same as IP5K4K.



NICE TO KNOW – BULBS



Quality of light

- Intensity of light (candela, cd)
The total amount of light emitted by a light source in a certain direction
- Luminous flux (Lumen, lm)
Total amount of light emitted by a light source per second
- Illuminance (lux, lx)
The total amount of light incident on a fixed surface
- Colour temperature

Intensity of light

The intensity of light is the total amount of light emitted by a light source. A light source often radiates in different directions with varying power. The intensity of light is the radiation of light in a certain direction. The unit of light intensity is candela [cd].

Luminous flux

Luminous flux is the amount of light a light source radiates in all directions per unit of time (per second). Luminous flux equals energy per unit of time and is expressed in watt. In lighting technology, the unit Lumen [lm] is used. Watt and Lumen have a ratio of: 1 watt = 683 Lumen

Illuminance

Illuminance [lx] is the total amount of light incident on a surface. Illuminance is about incident light and not emitted light. The unit lux [lx] is used to express illuminance.

Luminance

Luminance [cd/m^2] is the amount of light emitted or reverberated per unit of surface. Luminance is expressed as candela per square meter.

Colour temperature (Kelvin)

The colour temperature of a light source is the temperature of an ideal black-body radiator that radiates light of comparable hue to that of the light source. Colour temperature is expressed in Kelvin [K]. The wavelength of the emitted light decreases as the temperature rises. Blue light (short wavelength) has a higher colour temperature than red hues. Strangely enough, light with a low colour temperature is often experienced as warmer than light with a high colour temperature. An incandescent light bulb with warm white light has a temperature of 2700 K, a fluorescent bulb with natural light has a colour temperature of 6000 K.

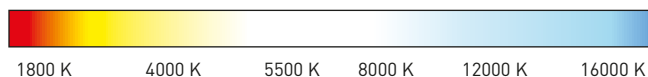

Examples

Temperature (Kelvin)	Description
1200	Candlelight
2000	Incandescent bulb
3200	Halogen bulb
5400	Standard value of a television
6000	Afternoon sun



NICE TO KNOW – CONNECTORS

Connectors

A lot of our lights are equipped with a connector. Each connector has a code: the number of that code indicates the number of possible connections of the connector. The letter is the position of the connector in the list of connectors.

Each light with at least one connector will be marked with the right connector code. This will make it easy for you to find the corresponding connector for a specific light.

If you are looking for a specific light for your machine, you can easily look up your lights via our online search engine MyPartsFinder by means of the truck details.

CONNECTORS – 1 PIN





CONNECTORS – 2 PINS



A2



B2



AMP C2



D2



Deutsch E2



F2



AMP G2



H2



I2



J2



K2

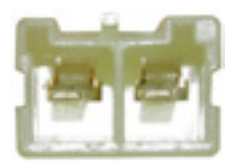

L2



M2



CONNECTORS – 3 PINS



CONNECTORS – 4 PINS





CONNECTORS – 5 PINS



CONNECTORS – 6 PINS

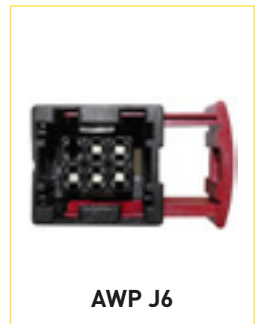



CONNECTORS – 7 PINS



A7



B7

CONNECTORS – 8 PINS



A8



INTERIOR LIGHTS



NICE TO KNOW – INTERIOR LIGHTS



The range of interior lighting consists of both fixed (ceiling) and gooseneck models. The latter have a flexible neck, allowing you to bend the light so it shines in the desired direction.

Interior lighting enables you to easily read documents (delivery notes, instructions, drawings ...) inside the driver cabin, or can provide extra lighting for the operating panel. Ideal to use in dark conditions.



READING LIGHTS

REF 151TA3929 – 12V length: 195 mm

REF 151TA3927 – 12V length: 600 mm

- Technology: incandescent
- Flexible arm
- Installation: surface-mounted, screw attachment
- Bulb included

REF 103TA4572 – Bulb: BA9S 12V 4W

REF 136TA3028 – Bulb: BA9S 12V 5W

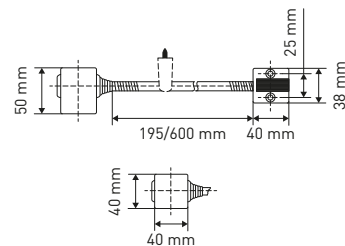

REF 151TA3928 – 24V length: 600 mm

- Technology: xenon
- Flexible arm
- Length: 500 mm
- Installation: surface-mounted, screw attachment
- With on/off switch
- Bulb included

REF 141TA9759 – Bulb: BA9S 28V 7,5W

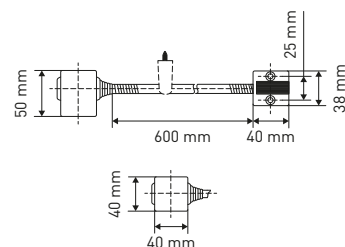



INTERIOR LIGHTS

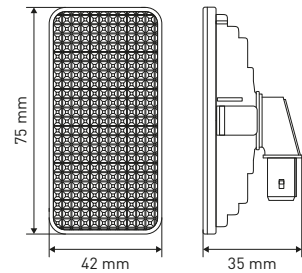

- REF 151TA3940** – 12V
- Technology: incandescent
 - Used on Linde
 - Bulb included

REF 103TA4555 – Bulb: W2,1x9,5D 12V 5W

TOTAL SOURCE®

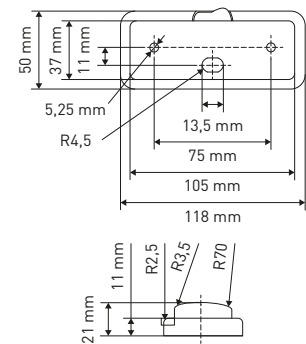

- REF 151TA3938**
- Technology: incandescent
 - Center distance: 75 mm
 - Installation: surface mounting 2 screws
 - 3 functions switch
 - 12–24V
 - Bulbs not included

REF 103TA4537 – Bulb: SV8,5-8 12V 5W

REF 103TA4539 – Bulb: SV8,5-8 24V 5W

TOTAL SOURCE®

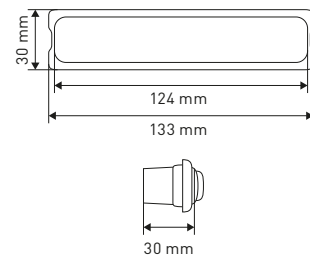

- REF 151TA3939**
- Technology: incandescent
 - Installation: surface mounting
 - 3 functions switch
 - 12–24V
 - Bulbs not included

REF 106TA4831 – Bulb: SV8,5-8 12V 10W

REF 106TA4907 – Bulb: SV8,5-8 24V 10W

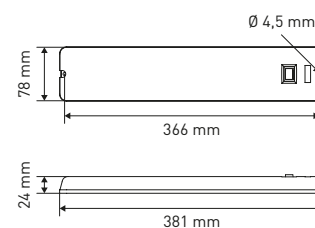

- REF 151TA3933** – 48V
- Technology: tube
 - Very low profile (24 mm)
 - Center distance: 366 mm
 - Tough polycarbonate lens
 - Tube included

REF 136TA3029 – Tube: G5 8W 4100K

REF 149TA7609 – Lens

TOTAL SOURCE®



INTERIOR LIGHTS

REF 129TA9944 – 24V

- Technology: tube
- Center distance: 262 mm
- Installation: surface mounting
- 3-functions switch integrated
- Tube included

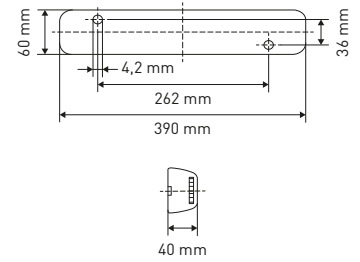

REF 136TA3029 – Tube: G5 8W 4100K

REF 151TA3936 – 12V

REF 140TA8987 – 24V

- Technology: tube
- Center distance: 250 mm
- Installation: surface mounting
- On/off switch integrated
- Tube included

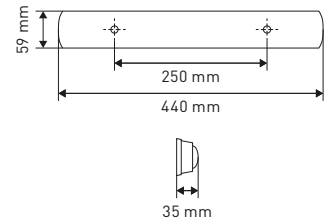

REF 136TA3029 – Tube: G5 8W 4100K

REF 151TA3930 – 24V

- Technology: tube
- IP65
- Protection class: II
- Cable: 5 m
- Tube included

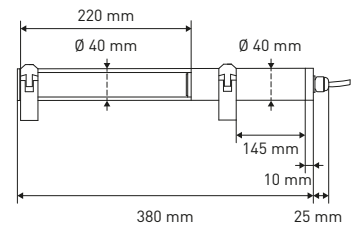

REF 142TA1335 – Tube: G23 11W 4000K

REF 164TA1118 – Mounting clamp





NOTES

A series of horizontal dotted lines for writing notes.



FRONT LIGHTS



NICE TO KNOW – FRONT LIGHTS



Front lights have a double function: they make sure that the vehicle is seen, while simultaneously making sure that the driver can see better.

They illuminate the surface in front of the vehicle by means of a bulb, mirror and lens. The beam of the dimmed headlights is directed downwards to prevent oncoming vehicles from being blinded.

Front lights are sometimes built into the machine, but they can also be installed on the machine.

Front lights are available in different shapes or models and technologies. There are front lights available with just one function, but there are also front lights that have multiple functions. These models are equipped with an indicator light, parking light, dimmed headlight or high-beam headlight, or a combination of these.



FRONT DRIVING LIGHTS

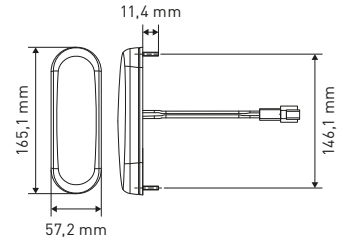

REF 151TA3285 – 12-48V without connector

REF 151TA3269 – 12-48V with connector F3

- Technology: LED
- Mounting: 2 bolts
- Wire length: 185 mm
- Functions: parking, turn
- IP67

E-approved

TOTAL SOURCE®

BRAND: SPEAKER

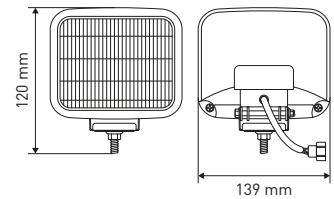

REF 151TA3212 – 24V

- Technology: incandescent
- Mounting: pedestal
- Wire length: 200 mm
- Functions: parking, dimmer
- Bulb included
- Connector: A3

REF 100TA2281 – Bulb: P15D 24V 62W/62W

TOTAL SOURCE®

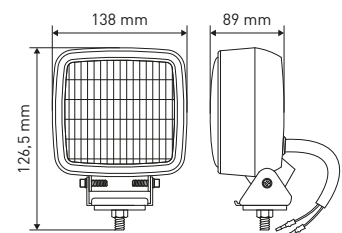

REF 151TA3213 – 48V

- Technology: incandescent
- Mounting: pedestal
- Wire length: 230 mm
- Function: dimmer
- Bulb included
- Connector: 2 x G1

REF 103TA4632 – Bulb: BA15S 48V 45W

REF 151TA3214 – Replacement lens

REF 151TA3152 – Bracket

TOTAL SOURCE®



FRONT DRIVING LIGHTS

REF 151TA3199 – 12V

- Technology: incandescent
- Mounting: 2 bolts
- Center distance: 58 mm
- Wire length: 285 mm
- Functions: parking, dimmer
- Bulbs included
- Connector: 1 x A1, 2 x G1

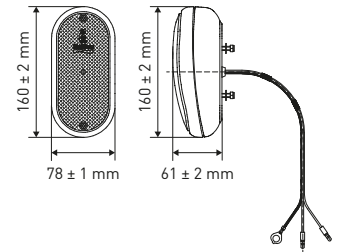

REF 103TA4585 – Bulb: BA15S 12V 5W

REF 122TA9122 – Bulb: BA15S 12V 21W orange

E-approved

TOTAL SOURCE®

BRAND: BRITAX

REF 151TA3282 – 12V LH

REF 151TA3283 – 12V RH

- Technology: halogen/incandescent
- Mounting: pedestal
- Wire length: 1000 mm
- Functions: parking, dimmer, turn
- Bulbs included
- Used on Heli

LH

RH

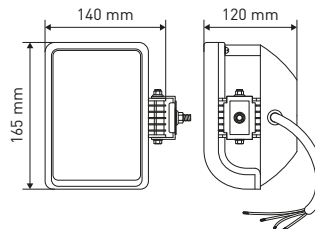

REF 142TA1238 – Bulb: W2,1x9,5D 12V 3,4W

REF 122TA9122 – Bulb: BA15S 12V 21W orange

REF 123TA8007 – Bulb: H3 12V 55W

TOTAL SOURCE®

REF 151TA3276 – 12V

- Technology: halogen/incandescent
- Mounting: single bolt
- Wire length: 1160 mm
- Functions: parking, dimmer, turn
- Bulbs included
- Connector: G4

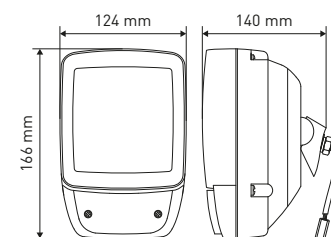

REF 103TA4572 – Bulb: BA9S 12V 4W

REF 103TA4596 – Bulb: BA15S 12V 10W

REF 123TA8007 – Bulb: H3 12V 55W

TOTAL SOURCE®



FRONT DRIVING LIGHTS

REF 151TA3305 – 12V LH

REF 151TA3306 – 12V RH

- Technology: halogen/incandescent
- Mounting: built-in
- Wire length: 150 mm
- Functions: parking, dimmer, turn
- Bulbs included
- Used for Toyota 7 series new model
- Connector: K6

REF 122TA9117 – Bulb: BA9S 12V 5W

REF 122TA9122 – Bulb: BA15S 12V 21W orange

REF 103TA4525 – Bulb: H3 12V 55W

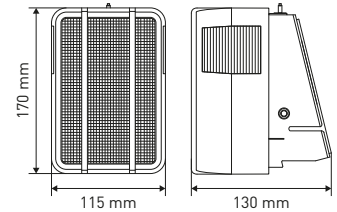

TOTAL SOURCE®

REF 151TA3154 – 12V LH

REF 151TA3155 – 12V RH

- Technology: halogen/incandescent
- Mounting: built-in
- Wire length: 220 mm
- Functions: parking, dimmer, turn
- Bulbs included
- Used for Toyota 7 series old model
- Connector: F3, B2

REF 122TA9117 – Bulb: BA9S 12V 5W

REF 122TA9122 – Bulb: BA15S 12V 21W orange

REF 103TA4525 – Bulb: H3 12V 55W

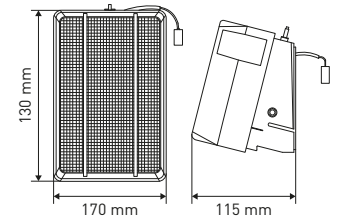

TOTAL SOURCE®

REF 152TA2445 – 12V LH

REF 148TA4739 – 12V RH

- Technology: halogen/incandescent
- Mounting: built-in
- Wire length: 100 mm
- Functions: parking, dimmer, turn
- Bulbs included
- Used for Toyota 7 series new model
- Connector: C3, L2

REF 103TA4555 – Bulb: W2,1x9,5D 12V 5W

REF 140TA8980 – Bulb: BAU15S 12V 21W orange

REF 103TA4525 – Bulb: H3 12V 55W

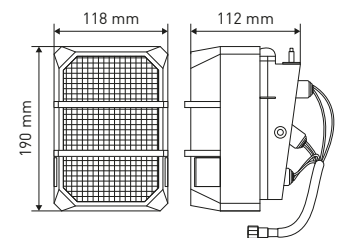

TOTAL SOURCE®



FRONT DRIVING LIGHTS

REF 151TA3329 – 48V LH

REF 151TA3330 – 48V RH

- Technology: incandescent
- Mounting: built-in
- Wire length: 220 mm
- Bulbs included
- Connector: K6

REF 103TA4598 – Bulb: BAY15D 48V 10W

REF 103TA4625 – Bulb: BAY15D 48V 25W

REF 103TA4636 – Bulb: BAY15D 48V 40W

REF 150TA1244 – Replacement lens

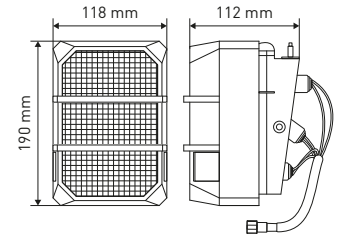

TOTAL SOURCE®

REF 151TA3284 – 12V

- Technology: halogen/incandescent
- Mounting: single bolt
- Wire length: 1230 mm
- Functions: parking, dimmer, turn
- Bulbs included
- Connector: F4

REF 103TA4575 – Bulb: BA9S 12V 4W

REF 122TA9113 – Bulb: BA15S 12V 21W

REF 123TA8007 – Bulb: H3 12V 55W

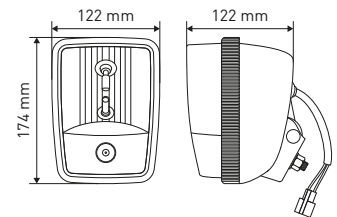

TOTAL SOURCE®

REF 151TA3203 – 12V LH

REF 151TA3204 – 12V RH

REF 151TA3205 – 48V LH

REF 151TA3206 – 48V RH

- Technology: halogen/incandescent
- Mounting: support
- Wire length: 125 mm
- Functions: parking, dimmer, turn
- Bulbs included
- Connector: A6

REF 100TA2164 – Bulb: BA9S 12V 4W

REF 122TA9113 – Bulb: BA15S 12V 21W

REF 119TA8915 – Bulb: BA9S 48V 4W

REF 103TA4636 – Bulb: BAY15D 48V 40W

REF 151TA3209 – Support

REF 151TA3207 – Clear lens

REF 151TA3208 – Amber lens

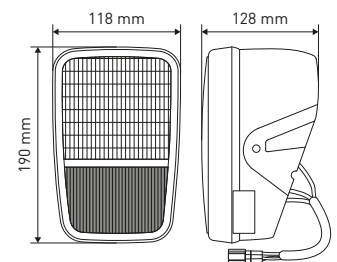

TOTAL SOURCE®



FRONT DRIVING LIGHTS

- REF 151TA3278** – 48V LH
- REF 151TA3277** – 48V RH
- Technology: incandescent
- Mounting: support
- Wire length: 230 mm
- Functions: dimmer, turn signal
- Bulbs included
- Connector: L4

- REF 123TA7992** – Bulb: BAY15D 48V 25W
- REF 103TA4636** – Bulb: BAY15D 48V 40W
- REF 151TA3209** – Support
- REF 151TA3207** – Clear lens
- REF 151TA3208** – Amber lens

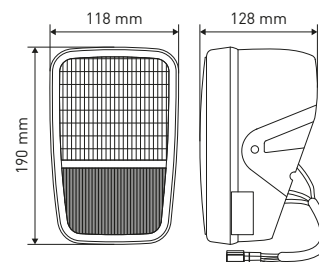

TOTAL SOURCE®

- REF 151TA3316** – LH
- REF 151TA3317** – RH
- Technology: halogen/incandescent
- Mounting: 4-point fixing (internal)
- 12–24V
- Bulbs not included

- REF 106TA4826** – Bulb: P45T-41 12V 45/40W
- REF 103TA4574** – Bulb: BA9S 12V 2W
- REF 103TA4576** – Bulb: BA9S 24V 2W
- REF 106TA4827** – Bulb: P45T-41 24V 55/50W

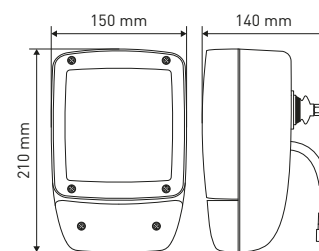

COBO®
grow

E-approved

- REF 151TA3301** – 12V Deutsch connection
- REF 151TA3302** – 24V Deutsch connection
- REF 151TA3303** – 12V AMP-connection
- REF 151TA3304** – 24V AMP-connection
- Technology: halogen/incandescent
- Mounting: support
- Functions: parking, dimmer, turn
- Bulbs included

- REF 103TA4572** – Bulb: BA9S 12V 4W
- REF 140TA8980** – Bulb: BAU15S 12V 21W orange
- REF 106TA4908** – Bulb: H7 12V 55W
- REF 106TA4840** – Bulb: BA9S 24V 4W
- REF 140TA8979** – Bulb: BAU15S 24V 21W orange
- REF 106TA4909** – Bulb: H7 24V 70W

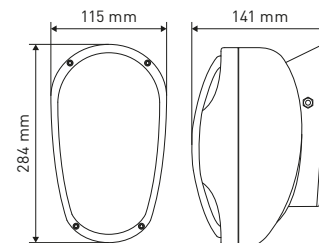

Deutsch connector



AMP connector



HELLA

E-approved



FRONT DRIVING LIGHTS

REF 151TA3292 – 12V

REF 151TA3294 – 24V

- Technology: halogen/incandescent
- Mounting: single bolt
- Functions: parking, dimmer, head, turn
- Bulbs included

REF 103TA4572 – Bulb: BA9S 12V 4W

REF 100TA2215 – Bulb: BA15S 12V 21W

REF 106TA4825 – Bulb: H4 12V 60/55W

REF 106TA4840 – Bulb: BA9S 24V 4W

REF 103TA4603 – Bulb: BA15S 24V 21W

REF 106TA4822 – Bulb: H4 24V 75/70W

REF 150TA4754 – Turn indicator lens

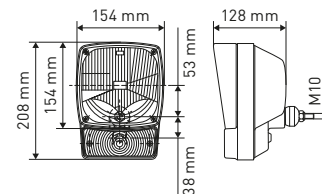

E-approved

REF 151TA3273 – 12V

- Technology: halogen/incandescent
- Mounting: single bolt
- Wire length: 280 mm
- Functions: parking, dimmer, head, turn
- Bulbs included
- Connector: K6

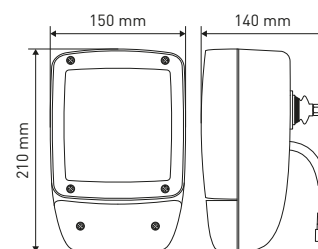

REF 103TA4572 – Bulb: BA9S 12V 4W

REF 100TA2215 – Bulb: BA15S 12V 21W

REF 123TA8012 – Bulb: H4 12V 60/55W

E-approved



REF 151TA3210 – 12V LH

REF 151TA3211 – 12V RH

- Technology: halogen/incandescent
- Mounting: single bolt
- Functions: parking, dimmer, head, turn
- Bulbs included
- Connector: E5

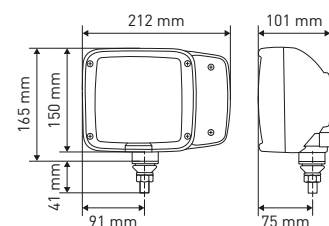

REF 103TA4572 – Bulb: BA9S 12V 4W

REF 100TA2215 – Bulb: BA15S 12V 21W

REF 103TA4525 – Bulb: H3 12V 55W

REF 106TA4909 – Bulb: H7 12V 55W

REF 150TA3160 – Indicator lens

REF 148TA5529 – Front light lens





FRONT DRIVING LIGHTS

REF 151TA3159 – 12V LH

REF 151TA3160 – 12V RH

- Technology: halogen/incandescent
- Mounting: single bolt
- Functions: parking, dimmer, head, turn
- Bulbs included
- Connector: O6 built-in

REF 103TA4572 – Bulb: BA9S 12V 4W

REF 100TA2215 – Bulb: BA15S 12V 21W

REF 103TA4525 – Bulb: H3 12V 55W

REF 106TA4909 – Bulb: H7 12V 55W

REF 148TA5529 – Front light lens

REF 150TA3160 – Indicator lens

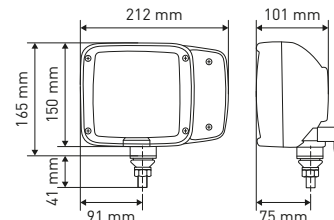

E-approved

Left-driving traffic

TOTAL SOURCE®

REF 151TA3197 – 12V LH

REF 151TA3198 – 12V RH

- Technology: halogen/incandescent
- Mounting: single bolt
- Functions: parking, dimmer, head, turn
- Bulbs included
- Connector: C6 built-in

REF 103TA4575 – Bulb: BA9S 12V 4W

REF 100TA2215 – Bulb: BA15S 12V 21W

REF 103TA4525 – Bulb: H3 12V 55W

REF 163TA8798 – Bulb: H7 12V 55W

REF 150TA4544 – Replacement headlight glass

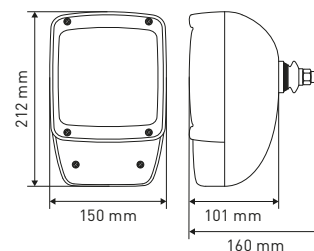

E-approved



REF 151TA3279 – 12V LH

REF 151TA3280 – 12V RH

- Technology: halogen/incandescent
- Mounting: single bolt
- Functions: parking, dimmer, head, turn
- Bulbs included
- Connector: C6 built-in

REF 103TA4575 – Bulb: BA9S 12V 4W

REF 100TA2215 – Bulb: BA15S 12V 21W

REF 103TA4525 – Bulb: H3 12V 55W

REF 163TA8798 – Bulb: H7 12V 55W

REF 150TA4544 – Replacement headlight glass

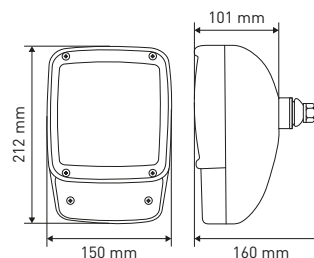

E-approved

Left-driving traffic





FRONT DRIVING LIGHTS

REF 151TA3200 – 12V LH

REF 151TA3201 – 12V RH

- Technology: halogen/incandescent
- Mounting: single bolt
- Functions: parking, dimmer, head, turn
- Bulbs included
- Connector: E5

REF 103TA4572 – Bulb: BA9S 12V 4W

REF 100TA2215 – Bulb: BA15S 12V 21W

REF 103TA4525 – Bulb: H3 12V 55W

REF 106TA4909 – Bulb: H7 12V 55W

REF 150TA3160 – Indicator lens

REF 148TA5529 – Front light lens

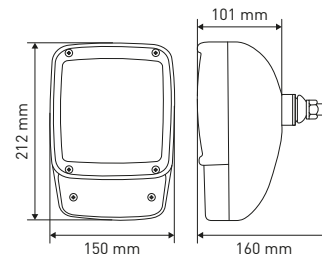

E-approved

REF 151TA3202

- Technology: halogen/incandescent
- Mounting: single bolt
- Functions: dimmer, head, turn
- 12-24V
- Bulbs not included

REF 103TA4575 – Bulb: BA9S 12V 4W

REF 103TA4530 – Bulb: H4 12V 60/55W

REF 106TA4840 – Bulb: BA9S 24V 4W

REF 123TA8013 – Bulb: H4 24V 75/70W

REF 148TA5581 – Replacement lens

REF 151TA3333 – Replacement lens amber

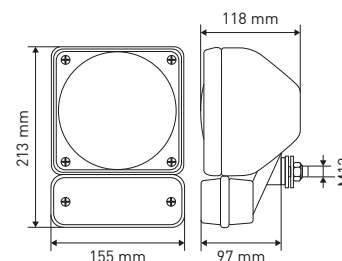

E-approved

REF 151TA3156 – 12V LH

REF 151TA3157 – 12V RH

- Technology: halogen/incandescent
- Center distance: 60 mm
- Functions: parking, dimmer, turn
- Bulbs included

REF 103TA4575 – Bulb: BA9S 12V 4W

REF 100TA2215 – Bulb: BA15S 12V 21W

REF 106TA4825 – Bulb: H4 12V 60/55W

REF 103TA4577 – Bulb: BA9S 24V 4W

REF 103TA4603 – Bulb: BA15S 24V 21W

REF 131TA4802 – Bulb: H4 24V 75/70W

REF 159TA9757 – Replacement lens amber

REF 150TA4948 – Replacement lens and cover

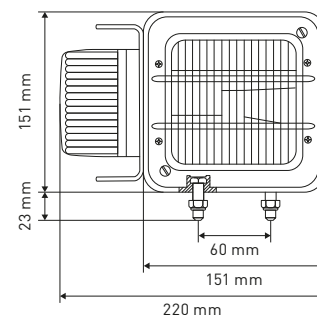

E-approved



FRONT DRIVING LIGHTS

REF [151TA3297](#) – 12V LH

REF [151TA3298](#) – 12V RH

REF [151TA3299](#) – 24V LH

REF [151TA3300](#) – 24V RH

- Technology: halogen/incandescent
- Mounting center distance: 60 mm
- Bulbs included
- Functions: parking, dimmer, turn

REF [103TA4575](#) – Bulb: BA9S 12V 4W

REF [100TA2215](#) – Bulb: BA15S 12V 21W

REF [106TA4825](#) – Bulb: H4 12V 60/55W

REF [103TA4577](#) – Bulb: BA9S 24V 4W

REF [103TA4603](#) – Bulb: BA15S 24V 21W

REF [131TA4802](#) – Bulb: H4 24V 75/70W

REF [159TA9757](#) – Replacement lens amber

REF [150TA4948](#) – Replacement lens and cover

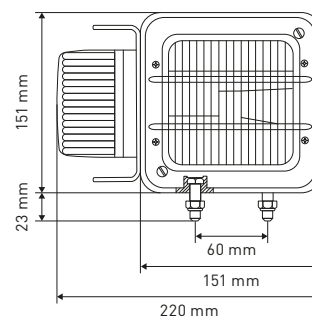

E-approved

REF [151TA3264](#) – 12V LH

REF [151TA3263](#) – 12V RH

- Technology: halogen/incandescent
- Mounting: single bolt
- Functions: parking, dimmer, head, turn
- Bulbs included
- Connector: C6 built-in

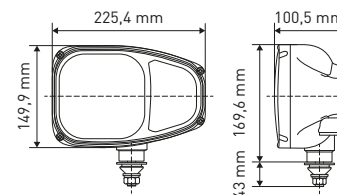

E-approved

REF [151TA3286](#) – 12V

REF [151TA3287](#) – 24V

- Technology: halogen/incandescent
- Mounting: single bolt
- Functions: parking, dimmer, head, turn
- Bulbs included
- Connector: C6 built-in

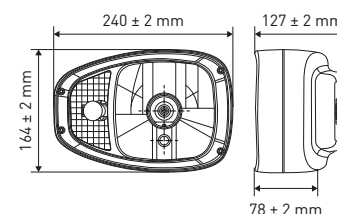

E-approved

REF [103TA4555](#) – Bulb: W2,1x9,5D 12V 5W

REF [140TA8980](#) – Bulb: BAU15S 12V 21W orange

REF [103TA4530](#) – Bulb: H4 12V 60/55W

REF [100TA2148](#) – Bulb: W 2,1x9,5D 24V 5W

REF [140TA8979](#) – Bulb: BAU15S 24V 21W orange

REF [100TA2105](#) – Bulb: H4 24V 75/70W



FRONT DRIVING LIGHTS

REF 151TA3295 – 12V LH

REF 151TA3296 – 12V RH

- Technology: halogen/incandescent
- Mounting: single bolt
- Wire length: 220 mm
- Functions: parking, dimmer, head, turn
- Bulbs included
- Connector: D6

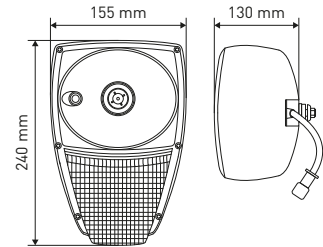

REF 103TA4572 – Bulb: BA9S 12V 4W

REF 140TA8980 – Bulb: BAU15S 12V 21W orange

REF 123TA8012 – Bulb: H4 12V 60/55W

E-approved

TOTAL SOURCE®

BRAND: NORDIC LIGHTS

REF 151TA3288 – 12V LH

REF 151TA3289 – 12V RH

REF 151TA3290 – 24V LH

REF 151TA3403 – 24V RH

- Technology: halogen/incandescent
- Mounting: single bolt
- Functions: parking, dimmer, head, turn
- IP69
- Bulbs included
- Connector: D6 built-in

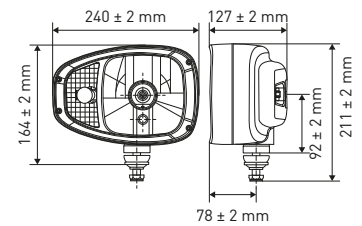

REF 103TA4572 – Bulb: BA9S 12V 4W

REF 140TA8980 – Bulb: BAU15S 12V 21W orange

REF 123TA8012 – Bulb: H4 12V 60/55 W

REF 106TA4840 – Bulb: BA9S 24V 4W

REF 140TA8979 – Bulb: BAU15S 24V 21W orange

REF 123TA8013 – Bulb: H4 24V 75/70W

E-approved

ABL

REF 151TA3320 – 12V LH

REF 151TA3321 – 12V RH

- Technology: halogen/incandescent
- Mounting: single bolt
- Functions: parking, dimmer, head, turn
- Bulbs included
- Connector: C6 built-in

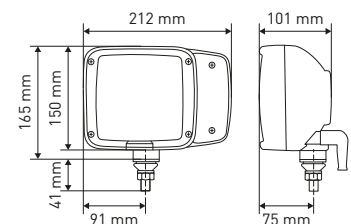

REF 103TA4572 – Bulb: BA9S 12V 4W

REF 100TA2215 – Bulb: BA15S 12V 21W

REF 103TA4525 – Bulb: H3 12V 55W

REF 106TA4909 – Bulb: H7 12V 55W

REF 148TA5529 – Replacement lens front light

REF 150TA3160 – Indicator lens

E-approved

HELLA



FRONT DRIVING LIGHTS

- REF 151TA3393** – 12V LH
REF 151TA3394 – 12V RH
- Technology: halogen/incandescent
 - Mounting: single bolt
 - Functions: parking, dimmer, head, turn signal
 - Bulbs included
 - Connector: D6 built-in

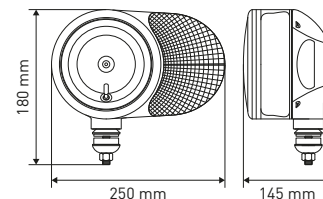

- REF 103TA4575** – Bulb: BA9S 12V 4W
REF 140TA8980 – Bulb: BAU15S 12V 21W orange
REF 123TA8012 – Bulb: H4 12V 60W

E-approved



- REF 151TA3325** – 12V LH
REF 151TA3326 – 12V RH
REF 151TA3327 – 24V LH
REF 151TA3328 – 24V RH
- Technology: halogen/incandescent
 - Center distance: 60 mm
 - Functions: parking, dimmer, head, turn
 - Bulbs included
 - Connecteur: C6 built-in

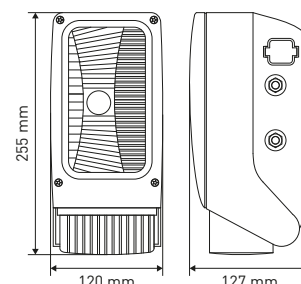

- REF 103TA4575** – Bulb: BA9S 12V 4W
REF 106TA4862 – Bulb: BA15S 12V 21W
REF 106TA4825 – Bulb: H4 12V 60/55W
REF 103TA4577 – Bulb: BA9S 24V 4W
REF 163TA8590 – Bulb: BA15S 24V 21W
REF 163TA8595 – Bulb: H4 24V 70/75W
REF 148TA4999 – Replacement lens headlight

E-approved



- REF 151TA3274** – 12V LH
REF 151TA3275 – 12V RH
- Technology: halogen/incandescent
 - Center distance: 200 mm
 - Functions: parking, dimmer, head, turn
 - Bulbs included
 - Connector: D6 built-in

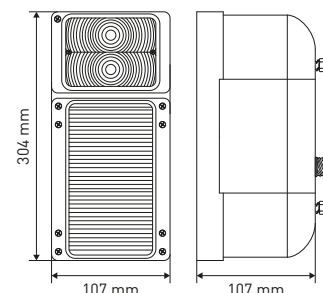

- REF 115TA4602** – Bulb: BA15S 12V 5W
REF 100TA2215 – Bulb: BA15S 12V 21W
REF 100TA2104 – Bulb: H4 12V 60/55W

E-approved





FRONT DRIVING LIGHTS

REF 151TA3307 – 12V LH

REF 151TA3308 – 12V RH

- Technology: halogen/incandescent
- Mounting center distance: 60 mm
- Functions: parking, dimmer, turn
- Bulbs included
- Connector: C6 built-in

REF 103TA4670 – Bulb: R2 12V 45/40W

REF 122TA9116 – Bulb: BA9S 12V 4W

REF 100TA2215 – Bulb: BA15S 12V 21W

REF 151TA3309 – Mirror and lens

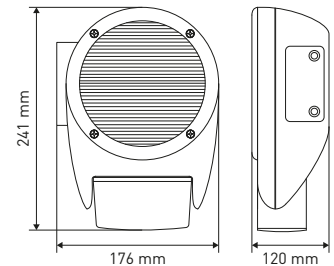

REF 151TA3158

- Technology: halogen/incandescent
- Mounting: pedestal
- 12–24V
- Functions: parking, dimmer, head
- Bulbs not included

REF 103TA4575 – Bulb: BA9S 12V 4W

REF 103TA4530 – Bulb: H4 12V 60/55W

REF 100TA2165 – Bulb: BA9S 24V 4W

REF 100TA2105 – Bulb: H4 24V 75/70W

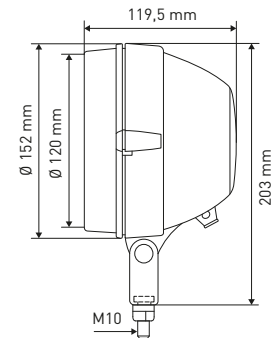

E-approved

REF 151TA3215

- Technology: halogen/incandescent
- Mounting: pedestal
- 12–24V
- Functions: parking, dimmer, head
- Bulbs not included

REF 103TA4575 – Bulb: BA9S 12V 4W

REF 103TA4530 – Bulb: H4 12V 60/55W

REF 100TA2165 – Bulb: BA9S 24V 4W

REF 100TA2105 – Bulb: H4 24V 75/70W

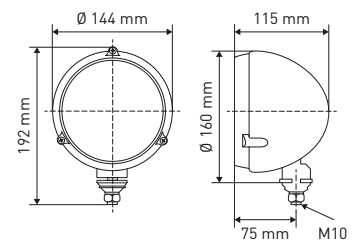

E-approved



FRONT DRIVING LIGHTS

REF 152TA2475

- Technology: halogen
- Mounting: pedestal
- 12-24V
- IP5K4K
- Bulb not included

REF 103TA4530 – Bulb: H4 12V 60/55W

REF 100TA2105 – Bulb: H4 24V 75/70W

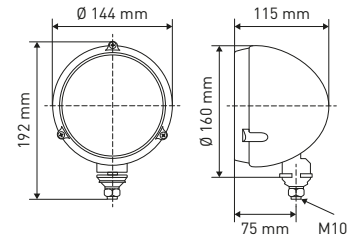

E-approved

- REF 151TA3395 – 12V LH blue
- REF 151TA3396 – 12V RH blue
- REF 151TA3397 – 12V LH red
- REF 151TA3398 – 12V RH red
- REF 151TA3399 – 12V LH black
- REF 151TA3400 – 12V RH black
- REF 151TA3401 – 12V LH white
- REF 151TA3402 – 12V RH white

- Technology: incandescent
- Mounting: pedestal
- Wire length: 65 mm
- Functions: dimmer, head
- Bulb included

REF 122TA9136 – Bulb: P22D 12V 50/40W

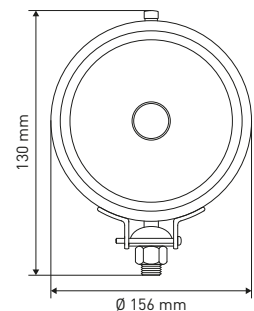
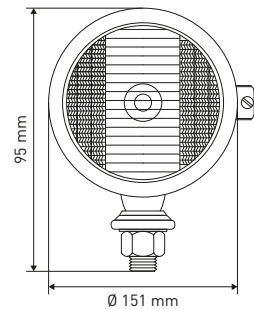

REF 152TA2478 – 24V

- Technology: halogen
- Mounting: pedestal
- Functions: dimmer, head
- Bulb included

REF 100TA2105 – Bulb: H4 24V 75/70W



E-approved



FRONT DRIVING LIGHTS

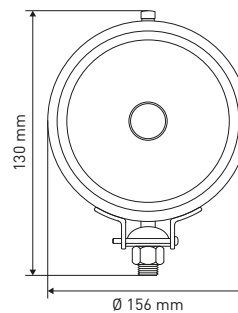

REF 152TA2482

- Technology: halogen
- Mounting: pedestal
- Functions: dimmer, head
- 12-24V
- IP54
- Bulb not included

REF 103TA4530 – Bulb: H4 12V 60/55W

REF 100TA2105 – Bulb: H4 24V 75/70W

E-approved





INDICATOR LIGHTS



NICE TO KNOW – INDICATOR LIGHTS



Indicator lights increase the safety: they warn the environment for the direction of movement of the vehicle and draw the attention on any terrain.

Indicator lights are available in different shapes, sizes and dimensions. We can also supply combination lights with indicator lights and a continuously lit marker light. In addition, there are also 'two-sided illumination' indicator lights.



BUILT-IN TURN SIGNAL LIGHTS



- REF **151TA4008** - 12V LH
- REF **151TA4009** - 12V RH
- Technology: LED
- Wire length: 315 mm
- Built-in
- Used for Hyster and Yale
- Connector: H3

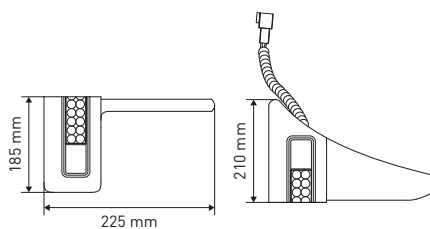

TOTAL SOURCE[®]



STANDARD TURN SIGNAL LIGHTS

REF 151TA4006

- Technology: incandescent
- Mounting: 2 screws
- Center distance: 28 mm
- 12V
- Bulb not included

REF 103TA4541 – Bulb: SV8.5-8 12V 18W

REF 150TA3789 – Replacement lens amber

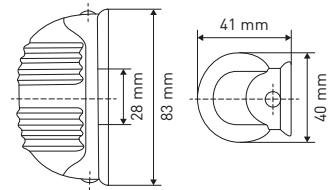

REF 151TA3959

- Technology: incandescent
- Mounting: 2 screws
- Center distance: 80 mm
- 12V
- Bulb not included

REF 106TA4830 – Bulb: SV 8.5-8 12V 5W

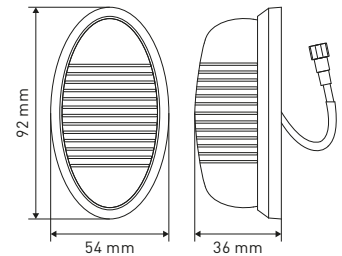

E-approved

TOTAL SOURCE[®]

REF 151TA3960 – 12V

- Technology: incandescent
- Mounting: 2 screws
- Center distance: 69 mm
- Wire length: 350 mm
- Bulb included
- Connector: B2

REF 103TA4538 – Bulb: SV 8,5-8 12V 10W

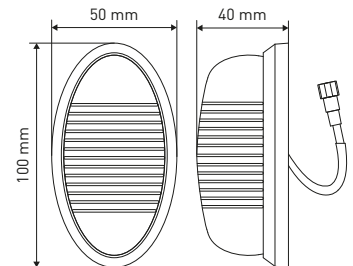

TOTAL SOURCE[®]

REF 151TA3976 – 12V

REF 151TA3977 – 48V

- Technology: incandescent
- Mounting: 2 screws
- Center distance: 60 mm
- Wire length: 260 mm
- Bulb included
- Connector: 1 x A1, 1 x H1

REF 100TA2215 – Bulb: BA15S 12V 21W

REF 106TA4865 – Bulb: BA15S 48V 25W

REF 150TA1024 – Replacement lens

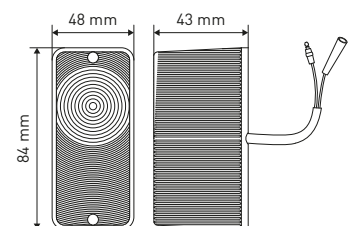

E-approved

TOTAL SOURCE[®]



STANDARD TURN SIGNAL LIGHTS

REF [151TA3979](#)

- Technology: incandescent
- Mounting: 2 screws
- Centre distance: 45 mm
- 12-24V
- Bulb not included

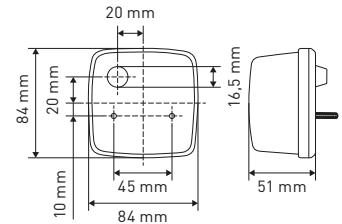

- REF [100TA2215](#) – Bulb: BA15S 12V 21W
- REF [103TA4603](#) – Bulb: BA15S 24V 21W
- REF [151TA3980](#) – Replacement lens amber

TOTAL SOURCE®

- REF [151TA3990](#) – 12V
- REF [151TA3991](#) – 24V
- Technology: incandescent
- Mounting: 2 screws
- Center distance: 80 mm
- Wire length: 400 mm
- Bulb included
- Connector: F1, 2 x G1

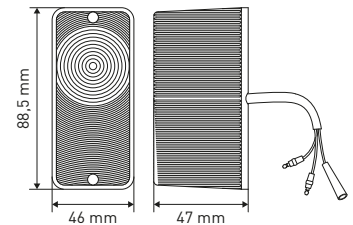

- REF [106TA4904](#) – Bulb: BAY15D 12V 23/8W
- REF [100TA2250](#) – Bulb: BAY15D 24V 25/10W

TOTAL SOURCE®

REF [151TA3956](#)

- Technology: incandescent
- Mounting: 2 screws
- Centre distance: 48 mm
- 12-24V
- Bulb not included

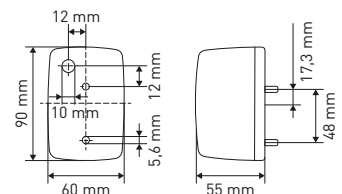

- REF [100TA2215](#) – Bulb: BA15S 12V 21W
- REF [103TA4603](#) – Bulb: BA15S 24V 21W
- REF [159TA9757](#) – Replacement lens

COBO®
group

- REF [151TA3985](#) – 48V
- REF [151TA3986](#) – 56V
- Technology: incandescent
- Mounting: 2 screws
- Centre distance: 79 mm
- Wire length: 110 mm
- Bulb included
- Connector: 2 x G1

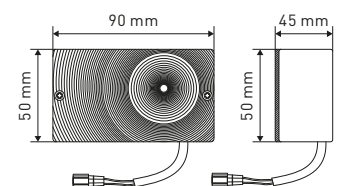

- REF [103TA4625](#) – Bulb: BAY15D 48V 25W
- REF [100TA2259](#) – Bulb: BAY15D 56V 25W
- REF [150TA2605](#) – Replacement lens

TOTAL SOURCE®



STANDARD TURN SIGNAL LIGHTS

- REF 151TA3987** – 48V
REF 151TA3986 – 56V
- Technology: incandescent
 - Mounting: 2 screws
 - Centre distance: 79 mm
 - Wire length: 235 mm
 - Bulb included
 - Connector: 1 x D1, 1 x H1

- REF 103TA4625** – Bulb: BAY15D 48V 25W
REF 100TA2259 – Bulb: BAY15D 56V 25W
REF 150TA2605 – Replacement lens

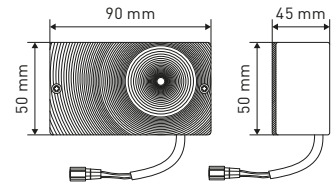

TOTAL SOURCE®

- REF 151TA3957**
- Technology: incandescent
 - Mounting: 2 screws
 - Center distance: 42 mm
 - 12–24V
 - Bulb not included

- REF 100TA2215** – Bulb: BA15S 12V 21W
REF 103TA4603 – Bulb: BA15S 24V 21W
REF 151TA3958 – Replacement lens

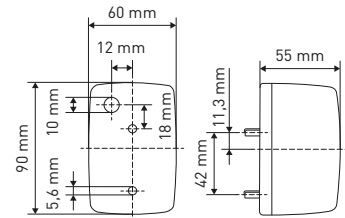

- REF 151TA3992** – 12V
- Technology: incandescent
 - Mounting: 2 screws
 - Center distance: 79 mm
 - Wire length: 140 mm
 - Bulb included
 - Connector: 1 x F1, 1 x G1

- REF 100TA2215** – Bulb: BA15S 12V 21W
REF 150TA1027 – Replacement lens

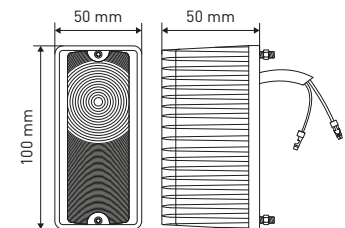

TOTAL SOURCE®

- REF 151TA3998** – 24V
- Technology: incandescent
 - Mounting: 2 screws
 - Center distance: 80 mm
 - Wire length: 120 mm
 - Bulb included
 - Connector: 3 x H1

- REF 106TA4875** – Bulb: BAY15D 24V 21/5W
REF 150TA1027 – Replacement lens front amber

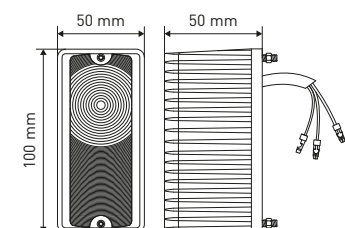

TOTAL SOURCE®



STANDARD TURN SIGNAL LIGHTS

- REF 151TA3994** – 12V
REF 151TA3995 – 24V
- Technology: incandescent
 - Mounting: 2 screws
 - Center distance: 60 mm
 - Wire length: 260 mm
 - Bulb included
 - Connector: 1 x A1, 1 x H1

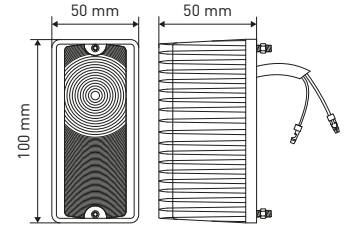
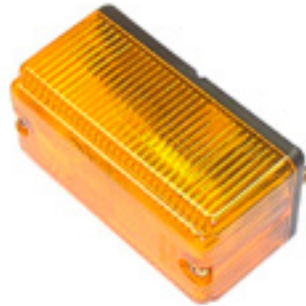

- REF 100TA2191** – Bulb: BA15S 12V 10W
REF 106TA4855 – Bulb: BA15S 24V 12W
REF 151TA3997 – Replacement lens amber
REF 150TA1259 – Replacement lens red

TOTAL SOURCE®

- REF 151TA3996** – 48V
- Technology: incandescent
 - Mounting: 2 screws
 - Center distance: 88 mm
 - Wire length: 150 mm
 - Bulb included
 - Connector: 1 x A1, 2 x G1

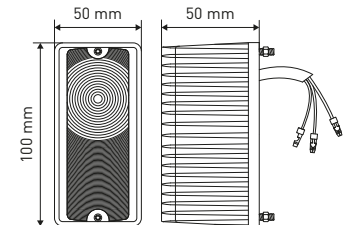
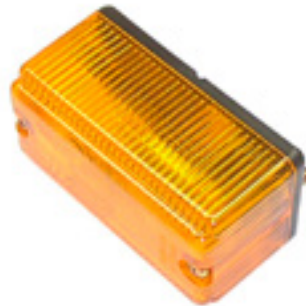

- REF 103TA4625** – Bulb: BAY15D 48V 25W
REF 151TA3997 – Replacement lens amber
REF 150TA1259 – Replacement lens red

TOTAL SOURCE®

- REF 151TA3993** – 24V
- Technology: incandescent
 - Mounting: 2 screws
 - Centre distance: 86 mm
 - Wire length: 140 mm
 - Functions: turn, marker
 - Bulb included
 - Connector: 3 x G1

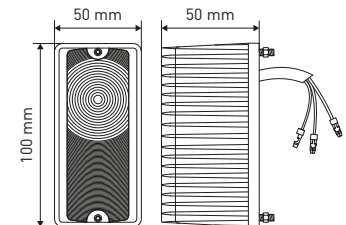

- REF 123TA7989** – Bulb: BAY15D 24V 21W
REF 150TA4734 – Replacement lens amber

TOTAL SOURCE®

- REF 151TA3999**
- Technology: incandescent
 - Mounting: 2 screws
 - Centre distance: 59 mm
 - 12–24V
 - Bulb not included

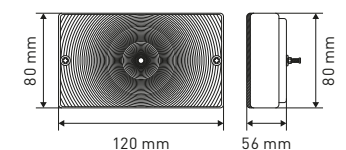

- REF 100TA2215** – Bulb: BA15S 12V 21W
REF 103TA4604 – Bulb: BA15S 24V 25W

TOTAL SOURCE®



STANDARD TURN SIGNAL LIGHTS

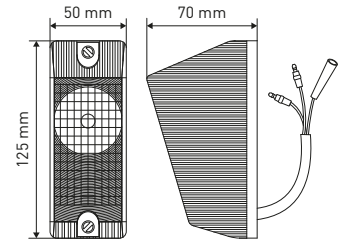

- REF 151TA4007** – 12V
- Technology: incandescent
 - Mounting: 2 screws
 - Center distance: 110 mm
 - Wire length: 185 mm
 - Functions: turn & marker
 - Bulb included
 - Connector: F1, 2 x G1

REF 106TA4904 – Bulb: BAY15D 12V 23/8W

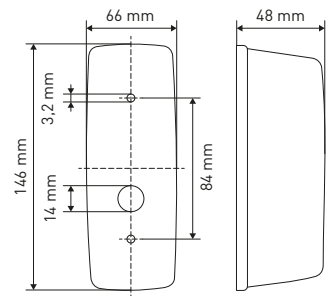

- REF 151TA4000** – LH
REF 151TA4001 – RH
- Technology: incandescent
 - Mounting: 2 screws
 - Center distance: 84 mm
 - 12–24V
 - Bulb not included

REF 100TA2215 – Bulb: BA15S 12V 21W

REF 103TA4603 – Bulb: BA15S 24V 21W



E-approved

- REF 151TA3961** – 12V
REF 151TA3962 – 24V
REF 151TA3963 – 48V
- Technology: incandescent
 - Mounting: 2 screws
 - Center distance: 140 mm
 - Wire length: 250 mm
 - Functions: turn, marker
 - Bulbs included
 - Connector: A1 & 2 x G1

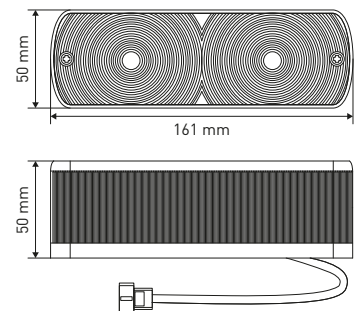

- REF 100TA2191** – Bulb: BA15S 12V 10W
REF 100TA2215 – Bulb: BA15S 12V 21W
REF 106TA4854 – Bulb: BA15S 24V 10W
REF 103TA4603 – Bulb: BA15S 24V 21W
REF 123TA7985 – Bulb: BA15S 48V 10W
REF 123TA7987 – Bulb: BA15S 48V 25W
REF 151TA3964 – Replacement lens





STANDARD TURN SIGNAL LIGHTS

- REF [151TA3965](#) – 12V
- REF [151TA3966](#) – 24V
- Technology: incandescent
- Mounting: 2 screws
- Center distance: 90 mm
- Wire length: 240 mm
- Functions: turn, marker
- Bulbs included
- Connector: 2 x G1

- REF [103TA4586](#) – Bulb: BA15S 12V 10W
- REF [100TA2215](#) – Bulb: BA15S 12V 21W
- REF [123TA7984](#) – Bulb: BA15S 24V 10W
- REF [103TA4603](#) – Bulb: BA15S 24V 21 W
- REF [150TA3528](#) – Replacement lens

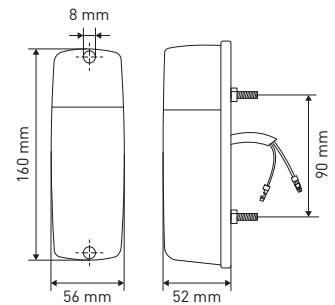

TOTAL SOURCE®

- REF [151TA4002](#) – 12V
- REF [151TA4003](#) – 24V
- REF [151TA4004](#) – 36V
- REF [151TA4005](#) – 48V
- Technology: incandescent
- Mounting: 2 screws
- Center distance: 149 mm
- Wire length: 300 mm
- Functions: turn, marker
- Bulbs included
- Connector: F3

- REF [100TA2191](#) – Bulb: BA15S 12V 10W
- REF [100TA2215](#) – Bulb: BA15S 12V 21W
- REF [123TA7984](#) – Bulb: BA15S 24V 10W
- REF [103TA4603](#) – Bulb: BA15S 24V 21 W
- REF [122TA9120](#) – Bulb: BAY15D 36V 8W
- REF [100TA2257](#) – Bulb: BAY15D 36V 25W
- REF [103TA4598](#) – Bulb: BAY15D 48V 10W
- REF [103TA4625](#) – Bulb: BAY15D 48V 25W

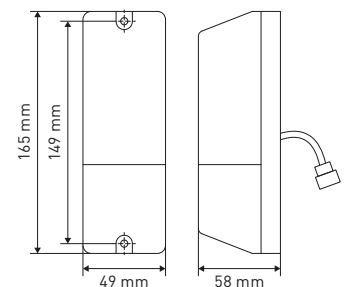

TOTAL SOURCE®



TWO-SIDED TURN SIGNAL LIGHTS

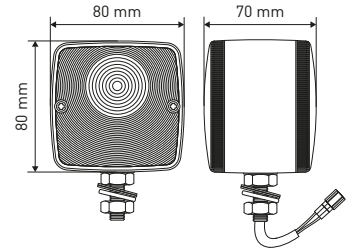

- REF 151TA3975** – 12V
- Technology: incandescent
 - Mounting: single bolt M12
 - Wire length: 385 mm
 - Bulb included
 - Connector: B2

- REF 123TA7983** – Bulb: BA15S 12V 10W
REF 151TA3970 – Replacement lens amber
REF 150TA5354 – Replacement lens rear red

TOTAL SOURCE®

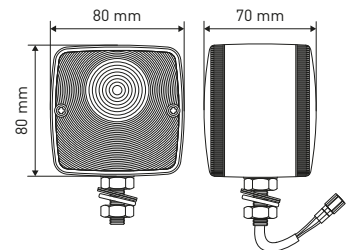

- REF 151TA3968** – 24V
- Technology: incandescent
 - Mounting: single bolt M12
 - Wire length: 220 mm
 - Functions: turn, marker
 - Bulbs included
 - Connector: 2 x G1

- REF 106TA4848** – Bulb: BA9S 24V 5W
REF 103TA4603 – Bulb: BA15S 24V 21W
REF 151TA3969 – Replacement lens front amber
REF 151TA3970 – Replacement lens rear amber

TOTAL SOURCE®

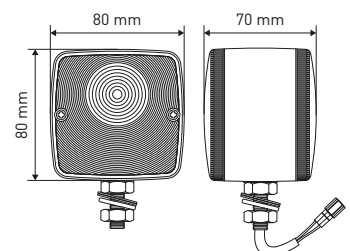

- REF 151TA3967** – 12V
REF 152TA8902 – 24V
- Technology: incandescent
 - Mounting: single bolt M12
 - Wire length: 220 mm
 - Functions: turn, marker
 - Bulbs included
 - Connector: H2

- REF 106TA4846** – Bulb: BA9S 12V 3W
REF 100TA2215 – Bulb: BA15S 12V 21W
REF 106TA4848 – Bulb: BA9S 24V 5W
REF 103TA4603 – Bulb: BA15S 24V 21W
REF 151TA3969 – Replacement lens front amber
REF 151TA3970 – Replacement lens rear amber

TOTAL SOURCE®



TWO-SIDED TURN SIGNAL LIGHTS

REF 151TA3972 – 12V

REF 151TA3973 – 24V

REF 151TA3974 – 48V

- Technology: incandescent
- Mounting: single bolt M12
- Wire length: 220 mm
- Functions: turn, marker
- Bulbs included
- Connector: A3

REF 106TA4846 – Bulb: BA9S 12V 3W

REF 100TA2215 – Bulb: BA15S 12V 21W

REF 106TA4848 – Bulb: BA9S 24V 5W

REF 103TA4603 – Bulb: BA15S 24V 21W

REF 103TA4581 – Bulb: BA9S 48V 5W

REF 123TA7987 – Bulb: BA15S 48V 25W

REF 151TA3969 – Replacement lens front amber

REF 151TA3970 – Replacement lens rear amber

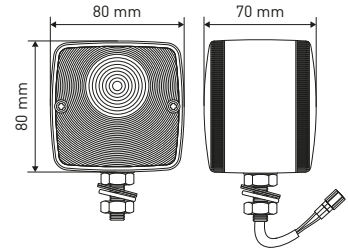

TOTAL SOURCE®

REF 151TA3971 – 48V

- Technology: incandescent
- Mounting: single bolt M12
- Wire length: 260 mm
- Functions: turn, marker
- Bulbs included
- Connector: A3

REF 103TA4581 – Bulb: BA9S 48V 5W

REF 151TA3978 – Bulb: BA15S 48V 25W

REF 151TA3969 – Replacement lens front amber

REF 106TA1328 – Replacement lens rear amber

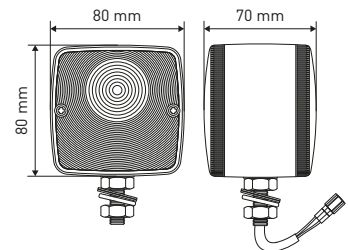

TOTAL SOURCE®

REF 151TA3981 – 12V

REF 148TA4167 – 24V

- Technology: incandescent
- Mounting: single bolt M12
- Wire length: 370 mm
- Functions: turn, marker
- Bulbs included
- Connector: 3W2RMBHB

REF 100TA2191 – Bulb: BA15S 12V 10W

REF 100TA2215 – Bulb: BA15S 12V 21W

REF 106TA1279 – Bulb: BA15S 24V 10W

REF 103TA4603 – Bulb: BA15S 24V 21W

REF 150TA2579 – Replacement lens front

REF 150TA2580 – Replacement lens rear

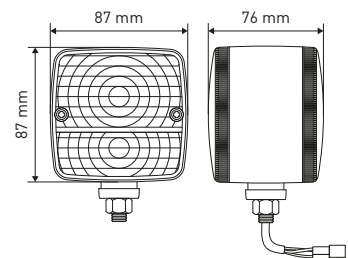

TOTAL SOURCE®



TWO-SIDED TURN SIGNAL LIGHTS

REF 151TA3984 – 12V

- Technology: incandescent
- Mounting: single bolt M12
- Wire length: 380 mm
- Bulbs included
- Connector: 1 x F1, 2 x G1

REF 103TA4596 – Bulb: BA15S 12V 10W

REF 100TA2215 – Bulb: BA15S 12V 21W

REF 150TA2579 – Replacement lens front

REF 150TA2580 – Replacement lens rear

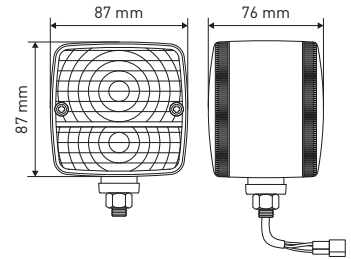

TOTAL SOURCE®

REF 151TA3988 – 12V

REF 151TA3989 – 24V

- Technology: incandescent
- Mounting: single bolt M12
- Wire length: 255 mm
- Functions: turn, marker
- Bulbs included
- Connector: 2 x G1

REF 100TA2191 – Bulb: BA15S 12V 10W

REF 122TA9113 – Bulb: BA15S 12V 21W

REF 106TA4854 – Bulb: BA15S 24V 10W

REF 103TA4603 – Bulb: BA15S 24V 21W

REF 150TA2579 – Replacement lens front

REF 150TA2580 – Replacement lens rear

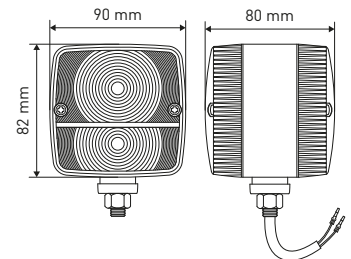

TOTAL SOURCE®

REF 151TA3982 – 12V

REF 151TA3983 – 48V

- Technology: incandescent
- Mounting: single bolt M12
- Wire length: 375 mm
- Functions: turn, marker
- Bulbs included
- Connector: C3

REF 103TA4585 – Bulb: BA15S 12V 5W

REF 122TA9113 – Bulb: BA15S 12V 21W

REF 131TA4767 – Bulb: BAY15D 48V 8W

REF 103TA4614 – Bulb: BA15D 48V 25W

REF 150TA2579 – Replacement lens front

REF 150TA2580 – Replacement lens rear

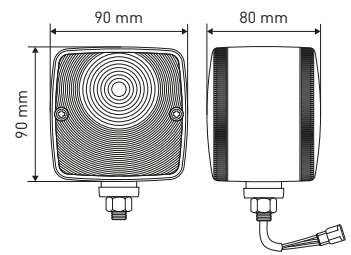

TOTAL SOURCE®



STANDARD TURN SIGNAL LIGHTS

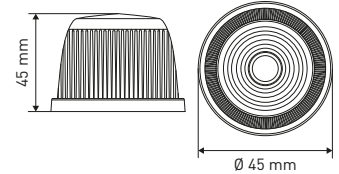

- REF 151TA3941** – 12V
- Technology: incandescent
 - Mounting: 2 screws
 - Center distance: 39 mm
 - Bulb not included

- REF 100TA2215** – Bulb: BA15S 12V 21W
REF 150TA5159 – Replacement lens

E-approved

TOTAL SOURCE®

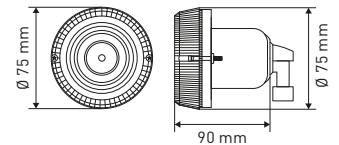

- REF 151TA3943** – Without bulb
REF 151TA3942 – 12V
- Technology: incandescent
 - Mounting: 2 screws
 - Center distance: 64 mm
 - Connector: B2 built-in

- REF 100TA2215** – Bulb: BA15S 12V 21W
REF 150TA4693 – Replacement lens rear amber

E-approved

COBO®
group

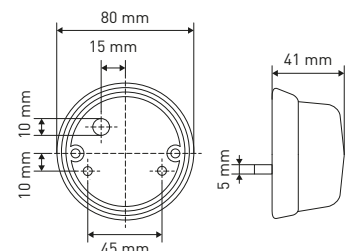

- REF 151TA3944**
- Technology: incandescent
 - Mounting: 2 screws
 - Center distance: 45 mm
 - 12V
 - Bulb not included

Red version, see page 126 (REF 151TA5982)
 Green version, see page 155 (REF 151TA3265)

- REF 103TA4541** – Bulb: SV 8,5-8 12V 18W
REF 150TA3793 – Replacement lens
REF 151TA3945 – Replacement base

E-approved

TOTAL SOURCE®



TWO-SIDED TURN SIGNAL LIGHTS

REF 151TA3946 – 12V

- Technology: incandescent
- Mounting: single bolt M12
- Wire length: 140 mm
- Functions: turn, marker
- Bulb included
- Connector: 1 x F1, 2 x G1

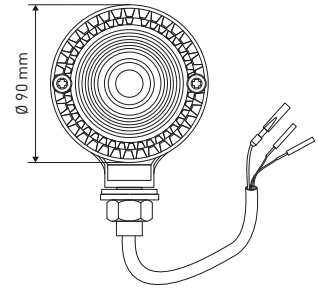

REF 123TA7988 – Bulb: BAY15D 12V 21/5W

TOTAL SOURCE®

REF 151TA3947 – 12V

- Technology: incandescent
- Mounting: single bolt M12
- Wire length: 240 mm
- Functions: turn, marker
- Bulbs included
- Connector: H2

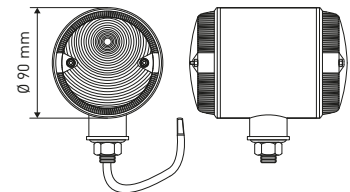

REF 106TA4846 – Bulb: BA9S 12V 3W

REF 100TA2215 – Bulb: BA15S 12V 21W

REF 151TA3948 – Replacement lens rear amber

TOTAL SOURCE®

REF 151TA3952 – 12V

REF 151TA3953 – 24V

- Technology: incandescent
- Mounting: single bolt M12
- Wire length: 220 mm
- Functions: turn, marker
- Bulbs included
- Connector: 2 x G1

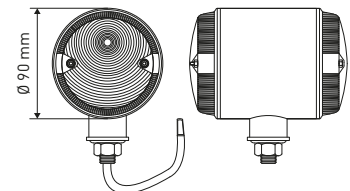

REF 106TA4846 – Bulb: BA9S 12V 3W

REF 100TA2215 – Bulb: BA15S 12V 21W

REF 163TA8586 – Bulb: BA9S 24V 5W

REF 103TA4603 – Bulb: BA15S 24V 21W

REF 150TA2535 – Replacement lens rear

TOTAL SOURCE®

REF 151TA3950 – 12V

- Technology: incandescent
- Mounting: single bolt M12
- Wire length: 350 mm
- Bulb included
- Connector: 2 x F1

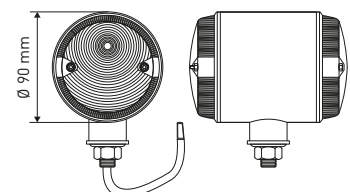

REF 100TA2215 – Bulb: BA15S 12V 21W

REF 151TA3951 – Replacement lens front

REF 151TA3949 – Replacement lens rear amber

TOTAL SOURCE®



ROTATING/FLASHING BEACONS



NICE TO KNOW – ROTATING/FLASHING BEACONS



With rotating beacons and strobe lights, you warn the environment of your presence.

Rotating beacons and strobe lights exist in 3 different technologies: LED, xenon and halogen.

Depending on the selected technology, a distinction is made between rotating beacons and strobe lights:

- LED technology is used in both rotating beacons and strobe lights. The rotating beacon is created by means of a specific sequence of flashes in the light
- Xenon technology is restricted to the creation of flashes
- Halogen lights use a mirror to project the light beam around

Strobe lights are often bolted onto lift trucks, or attached via a magnet or suction cup. On tractors, a more commonly used method is a 'pole mounting'.

We also have some 'plug-and-play' models available. These are equipped with a magnetic mounting base and a 12V plug and can very easily be (un)installed.

All LED and xenon beacons are supplied including the LED module or Xenon tube. The voltage or voltage range is always mentioned beside the reference. Beacons with halogen or bulb technology are following the same logic. The voltage of the included bulb is mentioned beside the reference and otherwise the spare bulbs are shown below the technical data.

A small range of beacons for priority vehicles are also available. The use of rotating beacons on priority vehicles is restricted. The user must observe the regulations on this subject.



LED FLASHING BEACONS

REF 151TA3825

- Technology: LED
- Mounting: magnetic mount
- 3-way switch for flashing or steady-on operation
- IP65
- Requires 4 AA batteries (not included)

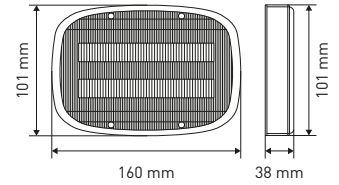

REF 106TA9001 – 4 AA batteries

Portable

TOTAL SOURCE[®]

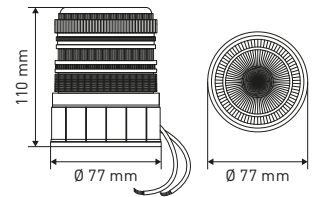

REF 164TA1461 – 10-30V

- Technology: LED
- Mounting: 2 screws
- IP69K

TOTAL SOURCE[®]

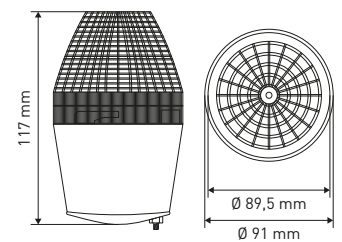

REF 151TA3699 – 24-48V

- Technology: LED
- Mounting: 2 screws
- Center distance: 71 mm
- IP65
- Flash rate: 120 flashes/minute
- Connector: J3 built-in

TOTAL SOURCE[®]



LED FLASHING BEACONS

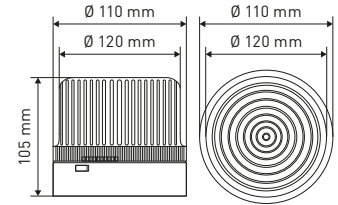

- REF 151TA3689** – 48V without cable
REF 151TA3690 – 48V with cable 250 mm
- Technology: LED
 - Mounting: 2 screws
 - Center distance: 90 mm
 - IP65
 - Flash rate: 120 flashes/minute

TOTAL SOURCE®

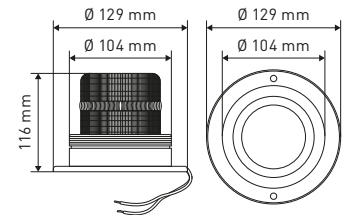

- REF 151TA3672** – 12–80V
- Technology: LED (3 pcs)
 - Mounting: 3 screws
 - Pitch circle: 115 mm
 - Wire length: 400 mm
 - IP65
 - Flash rate: 60 ± 90 flashes/minute
 - Economic version

TOTAL SOURCE®

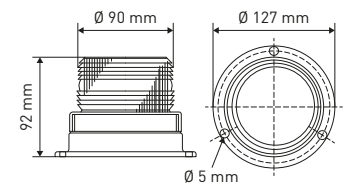

- REF 151TA3652** – 12–80V
- Technology: LED (6 pcs)
 - Mounting: 3 screws
 - Pitch circle: 115 mm
 - Wire length: 290 mm
 - IP65
 - Flash rate: 60 ± 10 flashes/minute
 - Lens not interchangeable

Made in USA

METEORLITE®



LED FLASHING BEACONS

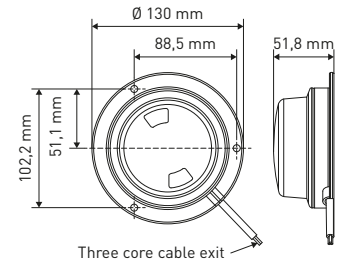

REF 151TA3637 – 10–30V

- Technology: LED
- Mounting: 3 screws
- Pitch circle: 115 mm
- Length cable: 95 mm
- IP67
- 12 flash patterns
- Low profice

TOTAL SOURCE®

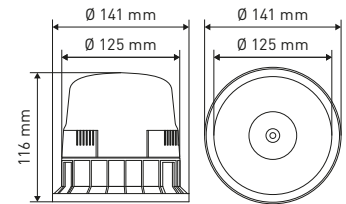

REF 149TA7223 – 12–30V

- Technology: LED
- Mounting: magnetic suction cap
- Roll cable
- 12V car plug

E-approved

TOTAL SOURCE®

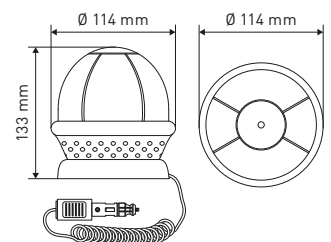

REF 149TA5328 – 12–30V

- Technology: LED
- Mounting: magnetic suction cap
- 12V car plug

E-approved

TOTAL SOURCE®



LED FLASHING BEACONS

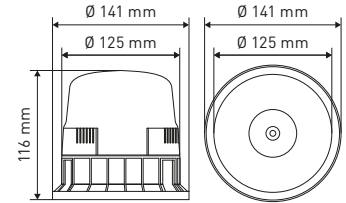

REF 151TA3653 – 10-30V

- Technology: LED
- Mounting: 3 screws
- Pitch circle: 126 mm
- Wire length: 170 mm

E-approved

TOTAL SOURCE®

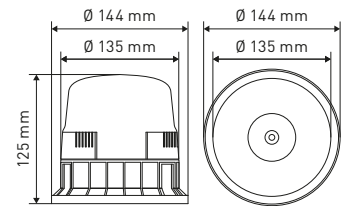

REF 164TA6653 – 12-24V

- High-powered LED, 12W
- Technology: LED
- Mounting: 3 bolts
- IP66
- Polycarbonate shockproof lens
- ECE R10

TOTAL SOURCE®

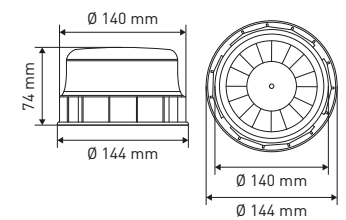

REF 149TA5329 – 10-30V

- Technology: LED
- Mounting: 3 screws
- Pitch circle: 130 mm
- IP6K9K
- Low profile

TOTAL SOURCE®



LED FLASHING BEACONS

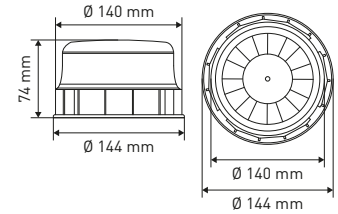

REF 149TA5332 – 10-30V

- Technology: LED
- Mounting: magnetic
- 12V car plug

TOTAL SOURCE®

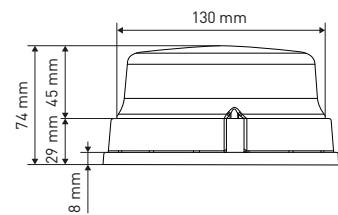

REF 151TA3814 – 12-24V 3 bolt fixation

- Technology: LED
- Mounting: 3 screws
- Pitch circle: 130 mm
- Low profile

TOTAL SOURCE®

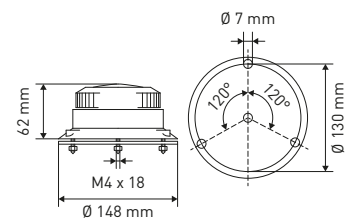

REF 151TA3641 – 20-100V

- Technology: LED
- Mounting: 3 screws
- Pitch circle: 130 mm
- IP65
- Flash rate: 60 flashes/minute
- Hardware included
- Low profile





LED FLASHING BEACONS

REF 151TA3700 - 12-110V

- Technology: LED
- Mounting: 3 screws
- Pitch circle: 130 mm
- IP65
- Flash rate: 60-80 flashes/minute
- 4 flashing patterns

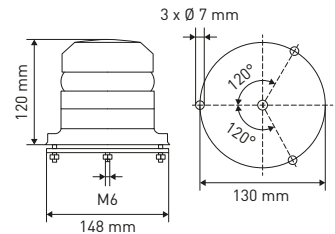

REF 151TA3701 - Lens amber

REF 164TA1466 - Support

Economic

TOTAL SOURCE[®]

REF 151TA3714 - 10-100V

- Technology: LED
- Mounting: 3 screws
- Pitch circle: 130 mm
- Wire length: 350 mm
- IP54
- Flash rate: 50 flashes/minute
- 3 flashing patterns

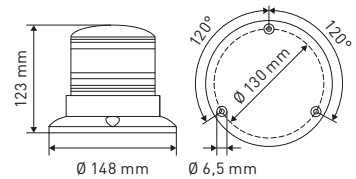

SIRENA s.p.a.

REF 151TA3723 - 12-48V

- Technology: LED
- Mounting: 3 screws
- Pitch circle: 130 mm
- Wire length: 580 mm
- IP69K
- Flash rate: 65 flashes/minute

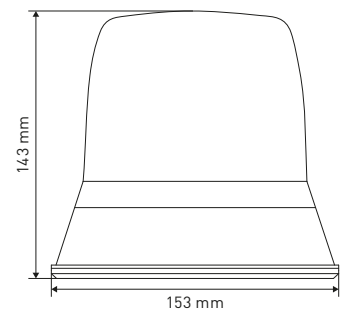

TOTAL SOURCE[®]



LED FLASHING BEACONS

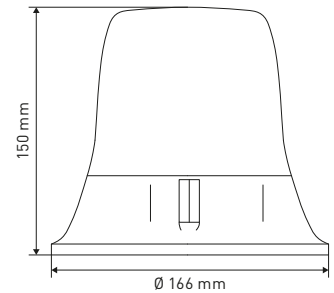

REF 151TA3786 – 12-48V

- Technology: LED
- Mounting: magnetic mount
- Flash rate: 65 flashes/minute
- 12V car plug

TOTAL SOURCE®

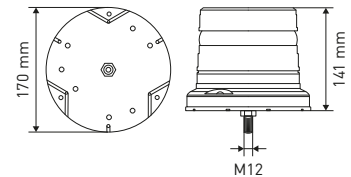

REF 151TA3719 – 10-30V

- Technology: LED
- Mounting: 3 screws
- Pitch circle 130 mm
- Wire length: 630 mm
- IP54
- 11 flash patterns

E-approved

TOTAL SOURCE®

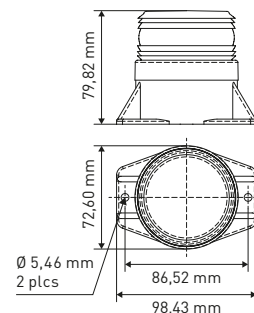

REF 151TA3759 – 12-80V

- Technology: LED
- Mounting: 2 screws
- Center distance: 86 mm
- IP66
- Flash rate: 60 ± 10 flashes/minute
- Low profile

REF 151TA3758 – Protection guard

Made in USA

METEORLITE®



LED FLASHING BEACONS

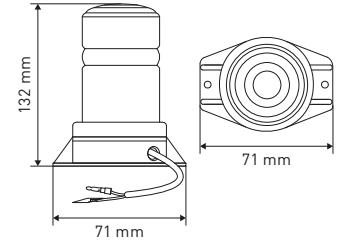

- REF 151TA3767** – 12-80V
- Technology: LED
 - Mounting: 2 screws
 - Center distance: 86 mm
 - Wire length: 400 mm
 - Connector: 1 x F1, 1 x G1
 - Hardware included

TOTAL SOURCE®

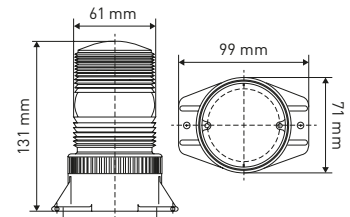

- REF 151TA3760** – 12-80V amber
REF 151TA3761 – 12-80V blue version
REF 151TA3762 – 12-80V clear version
REF 141TA1473 – 12-80V green version
REF 151TA3764 – 12-80V red version
- Technology: LED
 - Mounting: 2 screws
 - Center distance: 86 mm
 - Wire length: 300 mm
 - IP65
 - Flash rate: 60 ± 10 flashes/minute

E-approved

Made in USA

METEORLITE®

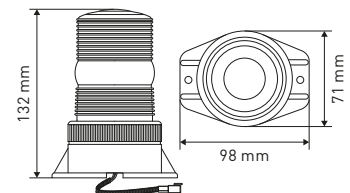

- REF 151TA3768** – 12-80V
- Technology: LED
 - Mounting: 2 screws
 - Center distance: 86 mm
 - Wire length: 410 mm
 - IP65
 - Flash rate: 60 flashes/minute
 - Connector: 2 x I2

Made in USA

METEORLITE®



LED FLASHING & ROTATING BEACON

REF 151TA3782 – Batteries

- Technology: LED
- Mounting:
 - magnetic mount
 - adapter plugs
 - suction pads
 - extra screws
- Wire length: 1520 mm
- IP66
- Flash rate: 60 flashes/minute
- Included:
 - car 12–24V DC charger
 - domestic 100–240V AC
 - 6 rechargeable AA batteries

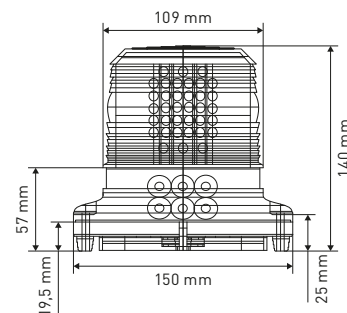

TOTAL SOURCE®

ROTATING/FLASHING BEACONS

XENON FLASHING BEACONS

REF 151TA3823 – 24V

- Technology: xenon
- Mounting: 2 screws
- Center distance: 130 mm
- Wire length: 450 mm
- Flash tube not replaceable
- Connector: E3

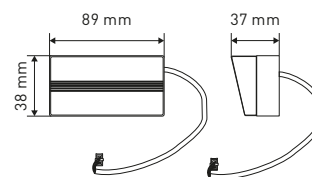

TOTAL SOURCE®

REF 151TA3824 – 12–110V

- Technology: xenon
- Mounting: 2 screws
- Wire length: 215 mm
- Nominuteal power: ± 3W
- IP66
- 72 flashes/minute
- Flash tube included

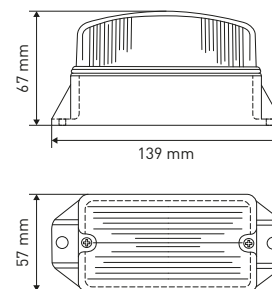

REF 151TA2306 – Lens amber

REF 106TA9146 – Protection guard

REF 106TA9126 – Flash tube

TOTAL SOURCE®



XENON FLASHING BEACONS

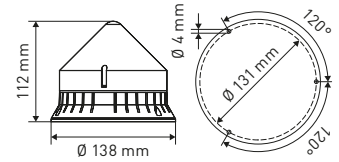

REF 151TA3650 – 10–100V

- Technology: xenon
- Mounting: 3 screws
- Pitch circle: 130 mm
- IP54
- Flash tube not replaceable
- Low profile

REF 151TA3649 – Lens amber

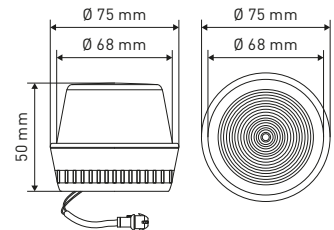

REF 151TA3634 – 10–32V

- Technology: xenon
- Mounting: 2 screws
- Center distance: 45 mm
- Wire length: 530 mm
- IP67
- Flash tube included
- Connector: C2

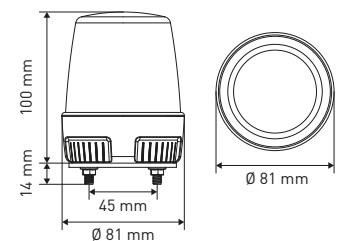

REF 151TA3675 – 10–100V without connector

REF 151TA3676 – 10–100V

- Technology: xenon
- Mounting: 2 screws
- Center distance: 45 mm
- Wire length: 460 mm
- IP67
- Flash tube included
- Connector: M2
- Used on Haulotte





XENON FLASHING BEACONS

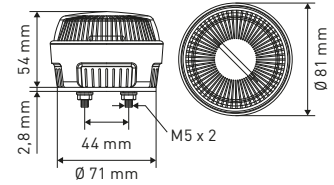

REF 151TA3640 – 10–100V

- Technology: xenon
- Mounting: 2 screws
- Center distance: 50 mm
- Wire length: 400 mm
- IP67
- Flash tube included

TOTAL SOURCE®

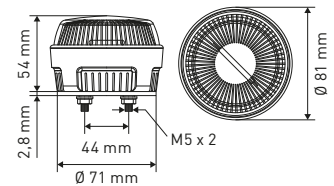

REF 151TA3635 – 10–100V white
REF 151TA3636 – 10–100V amber

- Technology: xenon
- Mounting: 2 screws
- Center distance: 45 mm
- Wire length: 450 mm
- IP67
- Flash tube included

TOTAL SOURCE®

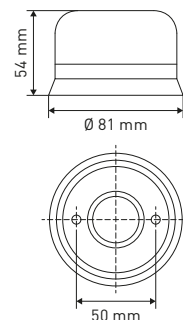

REF 151TA3638 – 12–24V

- Technology: xenon
- Mounting: 2 screws
- Center distance: 50 mm
- IP65
- Flash tube not replaceable

TOTAL SOURCE®



XENON FLASHING BEACONS

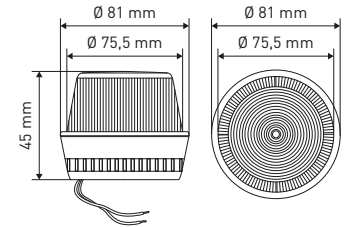

- REF 151TA3639** – 12-24V
- Technology: xenon
 - Mounting: 2 screws
 - Center distance: 45 mm
 - Wire length: 475 mm
 - IP67

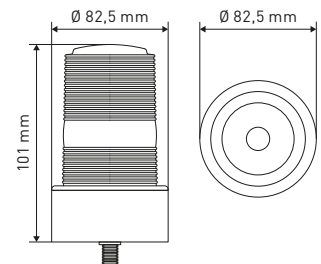

- REF 151TA3681** – 10-30V
- Technology: xenon
 - Mounting: 3 screws
 - Pitch circle: 49 mm
 - Wire length: 365 mm
 - IP67
 - Connector: J2

- REF 151TA3683** – Lens
REF 151TA3682 – Flash tube

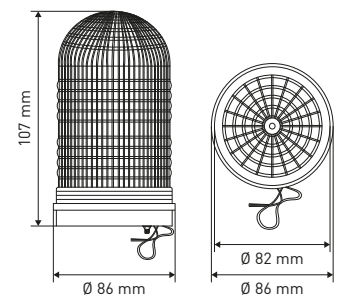

- REF 151TA3684** – 12-24V
- Technology: xenon
 - Mounting: 3 screws
 - Pitch circle: 45 mm
 - Wire length: 340 mm
 - Flash tube not replaceable





XENON FLASHING BEACONS

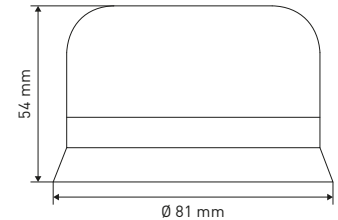

- REF 151TA3644** – 9–60V
- Technology: xenon
 - Mounting: central hole
 - IP65
 - Flash tube not replaceable

TOTAL SOURCE®

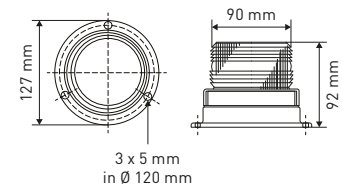

- REF 151TA3670** – 12–72V
- Technology: xenon
 - Mounting: 3 screws
 - Pitch circle: 115 mm
 - Wire length: 160 mm
 - IP54
 - Flash rate: 60 ± 10 flashes/minute
 - Connector: C2

- REF 106TA9126** – Flash tube
REF 111TA3637 – Flash tube 240V AC

TOTAL SOURCE®

- REF 151TA3677** – 12–110V amber
REF 151TA3679 – 12–110V green
REF 151TA3678 – 12–110V red
REF 106TA9123 – 12–110V blue
REF 106TA9124 – 12–110V clear
- Technology: xenon
 - Mounting: 3 screws
 - Pitch circle: 115 mm
 - Wire length: 200 mm
 - IP66
 - Flash rate: 60 ± 10 flashes/minute

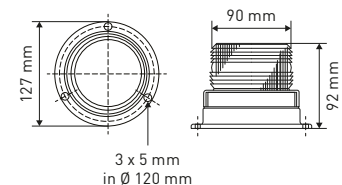

- REF 151TA3656** – Lens amber
REF 151TA3665 – Lens green
REF 151TA3678 – Lens red
REF 106TA9115 – Lens blue
REF 106TA9114 – Lens clear
REF 151TA3669 – Flash tube

TOTAL SOURCE®



XENON FLASHING BEACONS



- REF 151TA3783** – 12-110V amber
- Technology: xenon
 - Mounting: magnetic mount
 - Wire length: 1100 mm
 - IP66
 - Flash rate: 36 flashes/minute
 - 12V car plug

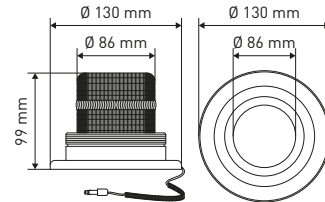

- REF 151TA3694** – Lens amber
REF 151TA2289 – Lens red
REF 150TA2426 – Lens blue
REF 151TA2290 – Lens white
REF 151TA3696 – Protection guard
REF 151TA3695 – Flash tube

TOTAL SOURCE®

Colour	12-110VDC	240AC
Amber	REF 151TA3654	REF 151TA3655
Blue	REF 151TA3657	REF 151TA3658
Clear	REF 151TA3660	REF 151TA3661
Green	REF 151TA3663	REF 151TA3664
Red	REF 151TA3666	REF 151TA3667



- Technology: xenon
- Mounting: 3 screws
- Pitch circle: 115 mm
- IP65
- Flash rate: 60 ± 10 flashes/minute

- REF 151TA3656** – Lens amber
REF 151TA3659 – Lens blue
REF 151TA3662 – Lens clear
REF 151TA3665 – Lens green
REF 151TA3668 – Lens red
REF 106TA9126 – Flash tube: 12-110V DC
REF 111TA3637 – Flash tube: 240V AC

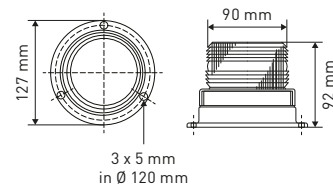

Made in USA

METEORLITE®



XENON FLASHING BEACONS

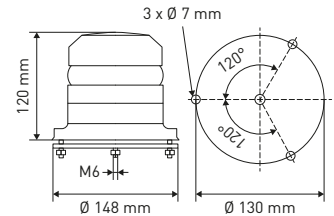

REF 151TA3651 – 12-110V

- Technology: xenon
- Mounting: 3 screws
- Pitch circle: 118 mm
- IP54

REF 160TA1088 – Flash tube

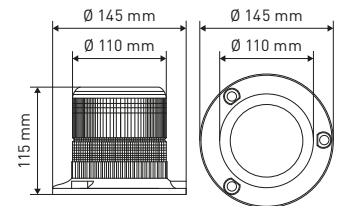

REF 151TA3691 – 10-100V

- Technology: xenon
- Mounting: 3 screws
- Pitch circle 130 mm
- Wire length: 490 mm
- IP65
- Flash rate 75 flashes/minute

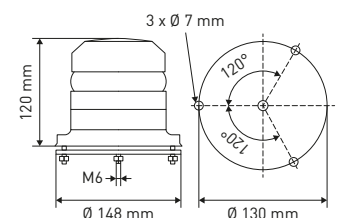

REF 151TA3697 – 12-24V

- Technology: xenon
- Mounting: 3 screws
- Pitch circle: 130 mm
- Wire length: 505 mm
- IP69K
- Flash rate: 125 flashes/minute

REF 151TA3698 – Flash tube





XENON FLASHING BEACONS

- REF 151TA3702** – 12-100V with short cable
- REF 151TA3703** – 12-100V with cable 4100 mm
- REF 151TA3704** – 12-100V with connector used on Still and Linde

- Technology: xenon
- Mounting: 3 screws
- Pitch circle: 130 mm
- Wire length: 440 mm
- IP54

REF 106TA9107 – Lens amber

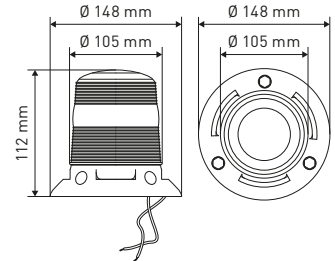

TOTAL SOURCE[®]

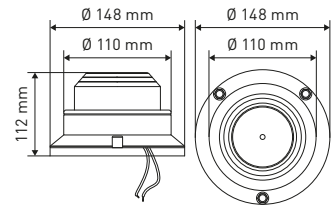

REF 151TA3643 – 12-110V

- Technology: xenon
- Mounting: 3 screws
- Pitch circle: 130 mm
- Wire length: 330 mm
- IP66
- Flash tube not replaceable

TOTAL SOURCE[®]

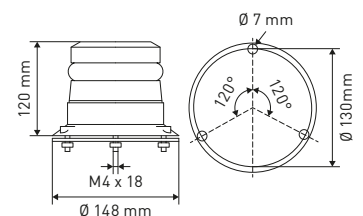

REF 151TA3708 – 12- 80V

- Technology: xenon
- Mounting: 3 screws
- Pitch circle: 130 mm
- Wire length: 465 mm
- IP67
- Flash rate: 72 flashes/minute
- Flash tube not replaceable

REF 151TA3701 – Lens amber

REF 151TA3709 – Protection guard

REF 151TA3710 – Mounting bracket





XENON FLASHING BEACONS

REF [151TA2424](#) – 10–120V

- Technology: xenon
- Mounting: 3 screws
- Pitch circle: 130 mm
- IP66
- Flash rate: 75 ± 10 flashes/minute
- Nominuteal power: ± 5W
- Flash tube included

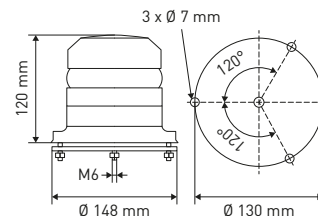

REF [151TA3707](#) – Flash tube

TOTAL SOURCE[®]

REF [151TA3705](#) – 10–110V

- Technology: xenon
- Mounting: 3 screws
- Pitch circle: 130 mm
- IP65
- Flash rate: 75 flashes/minute
- Nominuteal power: ± 7W
- Flash tube included

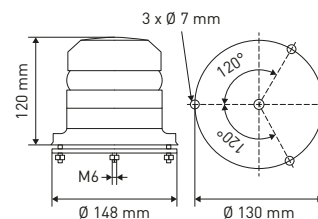

REF [151TA3706](#) – Flash tube

TOTAL SOURCE[®]

REF [151TA3712](#) – 10–110V

- Technology: xenon
- Mounting: 3 screws
- Pitch circle: 130 mm
- IP65
- Flash rate: 75 ± 10 flashes/minute
- Nominuteal power: ± 5W
- Flash Tube included

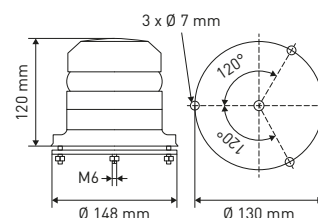

REF [151TA3713](#) – Flash tube

TOTAL SOURCE[®]



XENON FLASHING BEACONS

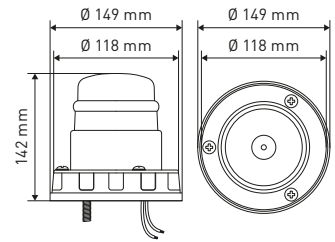

REF 151TA3721 – 10-72V

- Technology: xenon
- Mounting: 3 screws
- Pitch circle: 128 mm
- Wire length: 100 mm
- IP56
- Flash tube included

REF 151TA3722 – Flash tube



FLASHING BEACON WITH AUDIBLE SOUND

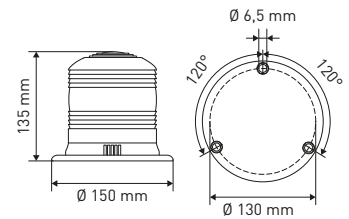

REF 151TA3720 – 10-100V

- Technology: xenon
- Mounting: 3 screws
- Pitch circle: 130 mm
- IP20
- Lens not interchangeable
- Flash tube not replaceable





XENON FLASHING BEACONS

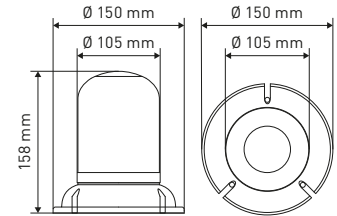

- REF 151TA3727** – 10-100V without cable
REF 151TA3728 – 10-100V with cable 1695 mm
- Technology: xenon
 - Mounting: 3 screws
 - Pitch circle: 130 mm
 - IP54
 - Flash rate: 60 ± 130 flashes/minute

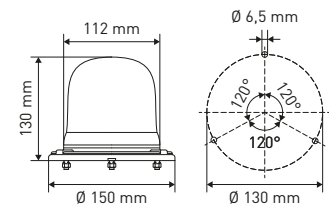

- REF 151TA3718** – 10-100V
- Technology: xenon
 - Mounting: 3 screws
 - Pitch circle 130 mm
 - Flash rate: 140 ± 10 flashes/minute

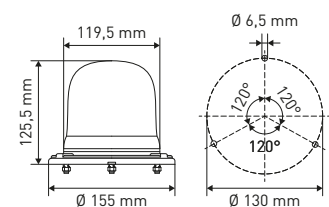

- REF 151TA3716** – 10-100V
- Technology: xenon
 - Mounting: 3 screws
 - Pitch circle 130 mm
 - IP54

- REF 151TA3717** – Flash tube





DOUBLE FLASH XENON STROBE LIGHT

REF [151TA3693](#) – 12-24V amber

REF [151TA3694](#) – 36-48V amber

- Technology: xenon
- Mounting: 3 screws
- Pitch circle: 150 mm
- Wire length: 255 mm
- Flash tube included

REF [151TA3694](#) – Lens amber

REF [151TA2289](#) – Lens red

REF [150TA2426](#) – Lens blue

REF [151TA2290](#) – Lens white

REF [151TA3695](#) – Flash tube

REF [151TA3696](#) – Protection guard

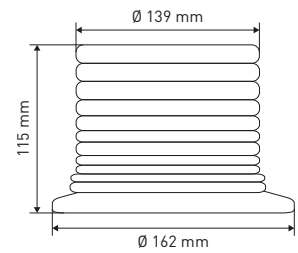

TOTAL SOURCE®

XENON FLASHING BEACONS

REF [151TA3692](#) – 12-24V

- Technology: xenon
- Mounting: 3 screws
- Pitch circle: 150 mm
- Wire length: 230 mm
- Flash tube included

REF [151TA2288](#) – Flash tube

REF [163TA8752](#) – Lens amber

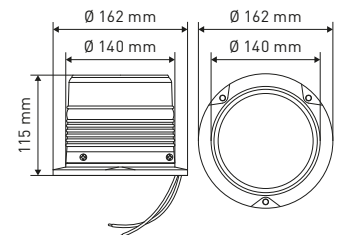

TOTAL SOURCE®

Double flash

REF [151TA3725](#) – 12-24V

- Technology: xenon
- Mounting: 3 screws
- Wire length: 150 mm
- IP65
- Flash tube included

REF [163TA8753](#) – Flash tube

REF [150TA2420](#) – Lens amber

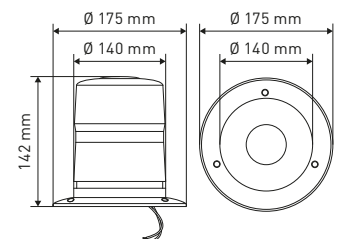

METEORLITE®



XENON FLASHING BEACONS



REF 151TA3755 – Wire length: 300 mm, Deutsch connector

REF 151TA3765 – Wire length: 240 mm

- Technology: xenon
- Mounting: 2 screws
- Center distance: 86 mm
- 12–80V
- IP66
- Flash tube included

REF 151TA3757 – Flash tube

REF 151TA3756 – Lens amber

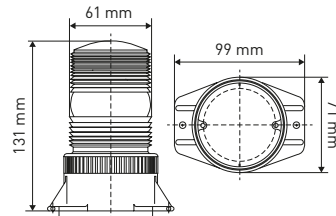

TOTAL SOURCE®



REF 151TA3769 – Amber

REF 151TA3770 – Blue

REF 151TA3772 – Clear

REF 151TA3774 – Green

REF 151TA3776 – Red

- Technology: xenon
- Mounting: 2 screws
- Center distance: 86 mm
- Wire length: 250 mm
- 12–80V
- IP67
- Flash rate: 75 flashes/minute
- Flash tube included

REF 151TA3756 – Lens amber

REF 151TA3771 – Lens blue

REF 151TA3773 – Lens clear

REF 151TA3775 – Lens green

REF 151TA3777 – Lens red

REF 151TA3757 – Flash tube

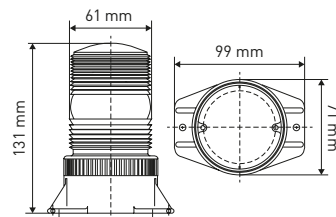

Made in USA

METEORLITE®



XENON FLASHING BEACONS

REF [151TA3779](#) – 12–80V

- Technology: xenon
- Mounting: 2 screws
- Center distance: 86 mm
- Wire length: 420 mm
- IP65
- Flash rate: 60 ± 80 flashes/minute
- Flash tube included

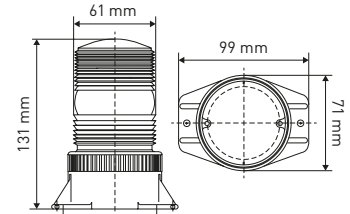

REF [151TA3780](#) – Flash tube

TOTAL SOURCE®

REF [151TA3752](#) – 10–100V with audible sound

- Technology: xenon
- Mounting: 4 screws
- Pitch circle: 130 mm
- IP55
- Flash tube included

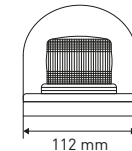
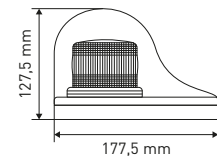

REF [150TA5024](#) – Lens amber

REF [151TA3753](#) – Flash tube

SIRENA s.p.a.

REF [151TA3754](#) – 12–110V

- Technology: xenon
- Mounting: magnetic
- Wire length: 1060 mm
- 72 flashes/minute
- IP65
- Flash tube included
- 12V car plug

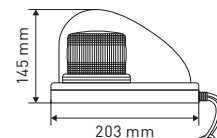

REF [151TA3669](#) – Flash tube

TOTAL SOURCE®



BULB FLASHING BEACONS

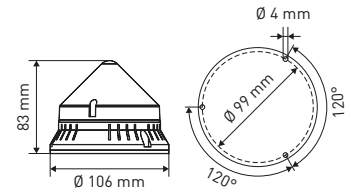

- REF 151TA3645** – 48V amber
- Technology: incandescent
 - Mounting: 3 screws
 - Pitch circle: 99 mm
 - IP54
 - Flash rate: 160 ± 30 flashes/minute
 - Bulb included

REF 119TA8919 – Bulb: BA15D 48V 10W

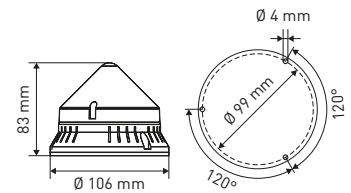

- REF 151TA3648** – 48V yellow
- Technology: incandescent
 - Mounting: 3 screws
 - Pitch circle: 99 mm
 - IP54
 - Flash rate: 160 ± 30 flashes/minute
 - Bulb included

E-approved

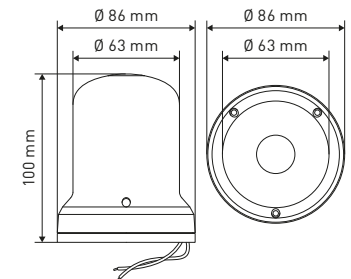

- REF 151TA3680** – 24V
- Technology: incandescent
 - Mounting: 3 screws
 - Pitch circle: 76 mm
 - Wire length: 230 mm
 - Bulb included

REF 103TA4603 – Bulb: BA15S 24V 21W





BULB STEADY BEACON

- REF 151TA3686** – Without bulb
- REF 151TA3687** – 24V with bulb
- REF 151TA3688** – 48V with bulb
- Technology: incandescent
- Mounting: 2 screws
- Center distance: 71 mm
- Wire length: 165 mm
- Connector: D2
- Uses flashing module of machine

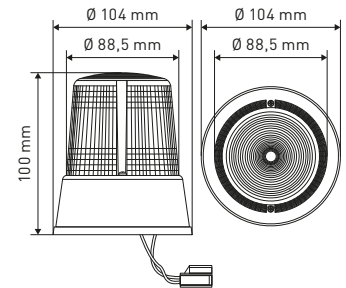

- REF 131TA4780** – Bulb: BA15D 24V 40W
- REF 106TA4902** – Bulb: BA15S 48V 40W



HALOGEN ROTATING BEACONS

- REF 151TA3726** – 12V
- Technology: halogen
- Mounting: 3 screws
- Pitch circle: 75 mm
- IP54
- Bulb included

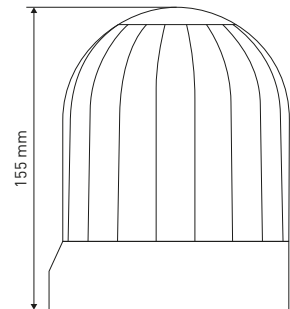

- REF 150TA5023** – Lens
- REF 123TA8005** – Bulb: H1 12V 55W

E-approved



- REF 151TA3732** – 24V
- Technology: halogen
- Mounting: 3 screws
- Pitch circle: 130 mm
- IP5K4K, IP9K
- Bulb included

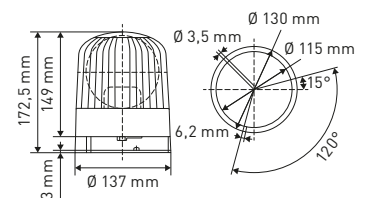

- REF 161TA6085** – Bulb: H1 24V 70W
- REF 150TA3844** – Lens amber

E-approved





HALOGEN ROTATING BEACONS

- REF 164TA1463** – 12-24V without bulb
REF 149TA4911 – 12V with bulb
- Technology: halogen
 - 12V
 - Mounting: 3 screws
 - Pitch circle: 130 mm

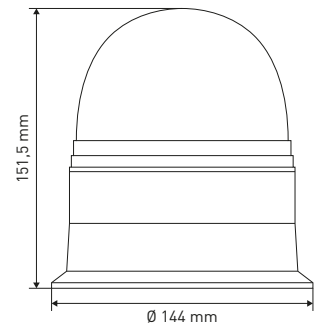

- REF 161TA5353** – Bulb: H1 12V 55W
REF 161TA6085 – Bulb: H1 24V 70W

E-approved

TOTAL SOURCE®

- REF 164TA1464**
- Technology: halogen
 - 12-24V
 - Mounting: suction caps
 - Bulb not included
 - 12V car plug

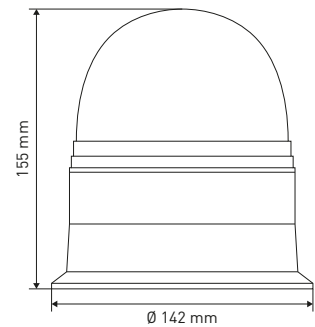

- REF 161TA5353** – Bulb: H1 12V 55W
REF 161TA6085 – Bulb: H1 24V 70W

E-approved

TOTAL SOURCE®

- REF 151TA3739**
- Technology: halogen
 - 12-24V
 - Mounting: 3 screws
 - Pitch circle: 130 mm
 - Wire length: 260 mm
 - IP54
 - Rotation rate: 160 ± 20 rotations/minute
 - Bulb not included

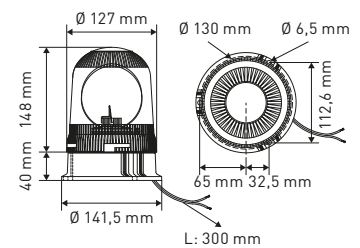

- REF 123TA8005** – Bulb: H1 12V 55W
REF 123TA8006 – Bulb: H1 24V 70W

E-approved

TOTAL SOURCE®



HALOGEN ROTATING BEACONS

REF [151TA3735](#)

- Type technologie: halogen
- 12-24V
- Mounting: pole mounting, 3 screws
- Pitch circle: 130 mm
- IP55
- Bulb not included

REF [123TA8005](#) – Bulb: H1 12V 55W

REF [123TA8006](#) – Bulb: H1 24V 70W

REF [150TA3148](#) – Lens

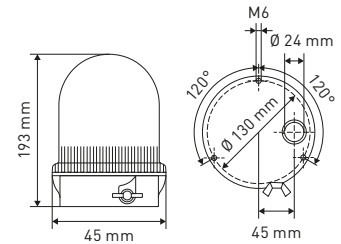

E-approved



BULB ROTATING BEACON



REF [151TA3743](#) – Without bulb

REF [164TA7819](#) – 36V

REF [151TA3744](#) – 48V

REF [151TA3745](#) – 80V

- Technology: incandescent
- 12-80V
- Mounting: 3 screws
- Pitch circle: 130 mm
- IP54
- Rotation rate: 160 ± 30 rotations/minute

REF [106TA9127](#) – Lens amber

REF [106TA9128](#) – Lens blue

REF [106TA9129](#) – Lens green

REF [103TA4664](#) – Bulb: BA20S 36V 35W

REF [106TA9138](#) – Bulb: BA20S 48V 35W

REF [123TA8001](#) – Bulb: BA20S 80V 35W

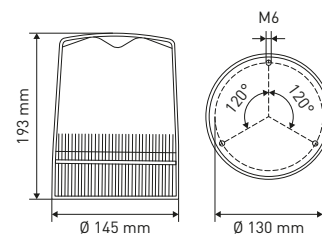



HALOGEN ROTATING BEACONS

- REF [151TA3738](#) – without bulb
- REF [151TA3736](#) – 12V
- REF [151TA3737](#) – 24V
- Technology: halogen
- 12-24V
- Mounting: 3 screws
- Pitch circle: 130 mm
- IP54
- Rotation rate: 160 ± 30 rotations/minute

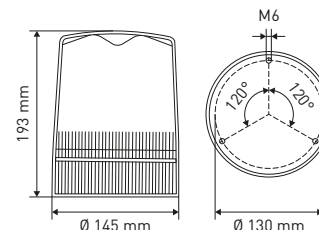

- REF [106TA9127](#) – Lens amber
- REF [106TA9128](#) – Lens blue
- REF [106TA9129](#) – Lens green
- REF [106TA9130](#) – Lens red
- REF [123TA8005](#) – Bulb: H1 12V 55W
- REF [123TA8006](#) – Bulb: H1 24V 70W

E-approved



- REF [151TA3715](#) – 24V
- Technology: halogen
- Mounting: 3 screws
- Pitch circle: 130 mm
- IP55
- Bulb included

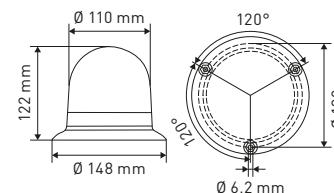

- REF [123TA8006](#) – Bulb: H1 24V 70W

E-approved



- REF [151TA3729](#) – Without bulb
- REF [151TA3730](#) – 12V
- REF [151TA3731](#) – 24V
- Type technologie: halogen
- Mounting: 3 screws
- Pitch circle: 130 mm
- IP54
- Rotation rate: 160 ± 30 rotations/minute

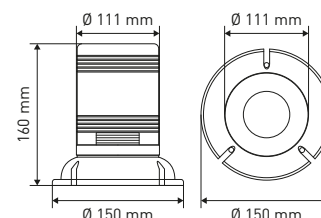

- REF [151TA3647](#) – Protection guard
- REF [151TA2281](#) – Support
- REF [161TA5353](#) – Bulb: H1 12V 55W
- REF [161TA6085](#) – Bulb: H1 24V 70W

E-approved





HALOGEN ROTATING BEACONS

- REF **151TA3748** – 12V without cable
- REF **151TA3749** – 12V with cable
- Technology: halogen
- Mounting: 3 screws
- Pitch circle: 130 mm
- Wire length: 120 mm
- IP65
- Rotation rate: 180 ± 30 rotations/minute
- Bulb included

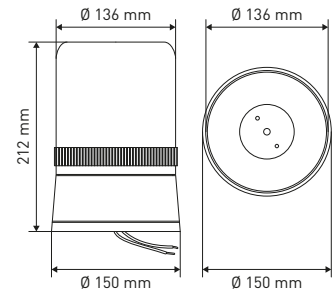

- REF **151TA3750** – Protection guard
- REF **151TA3751** – Lens amber
- REF **144TA5476** – Bulb: H1 12V 55W

E-approved

TOTAL SOURCE®

- REF **151TA3724** – 12V
- Technology: halogen
- Mounting: 3 screws
- Pitch circle: 130 mm
- Wire length: 100 mm
- IP54
- Rotation rate: 160 ± 30 rotations/minute
- Bulb included

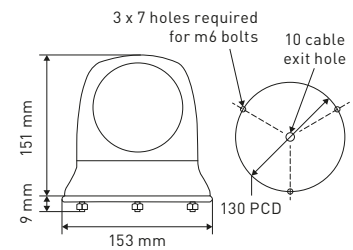

- REF **144TA5476** – Bulb: H1 12V 55W

E-approved

TOTAL SOURCE®

BRAND: BRITAX

- REF **151TA3733** – Without bulb
- REF **151TA3734** – 12V
- REF **149TA4303** – 24V
- Technology: halogen
- Mounting: 3 screws
- Pitch circle: 130 mm
- Wire length: 185 mm
- IP56
- Rotation rate: 180 rotations/minute
- Bulb not included

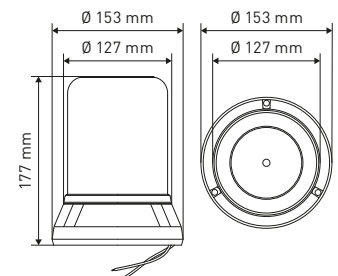

- REF **123TA8005** – Bulb: H1 12V 55W
- REF **123TA8006** – Bulb: H1 24V 70W

E-approved

TOTAL SOURCE®



HALOGEN ROTATING BEACONS

REF 151TA3787 – 12V

- Technology: halogen
- Mounting: magnetic mount
- Wire length: 550 mm
- IP54
- Rotation rate: 160 rotations/minute
- Bulb included
- 12V car plug

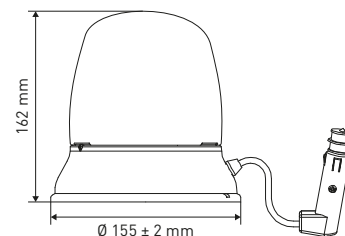

REF 123TA8005 – Bulb: H1 12V 55W

E-approved

TOTAL SOURCE®
BRAND: BRITAX

REF 151TA3740 – 12V

REF 151TA3741 – 24V

- Technology: halogen
- Mounting: 3 screws
- Pitch circle: 130 mm
- IP5K4K, IP9K
- Rotation rate: 160 rotations/minute
- Bulb included

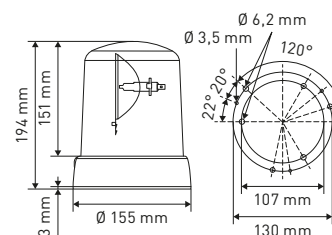

REF 123TA8005 – Bulb: H1 12V 55W

REF 123TA8006 – Bulb: H1 24V 70W

E-approved



REF 151TA3742 – 24V

- Technology: halogen
- Mounting: 3 screws
- Pitch circle: 130 mm
- IP5K4K, IP9K
- Rotation rate: 160 rotations/minute
- Bulb included

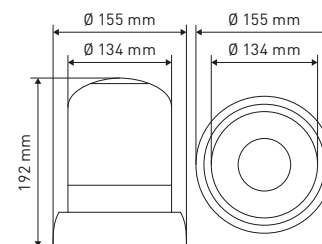

REF 123TA8006 – Bulb: H1 24V 70W

E-approved





BULB ROTATING BEACON

REF 151TA3747 – 48V

- Technology: incandescent
- Mounting: 3 screws
- Pitch circle: 136 mm
- Wire length: 280 mm
- IP23
- Rotation rate: 140 ± 25 rotations/minute
- Bulb included

REF 103TA4634 – Bulb: BA15D 48V 35W

REF 150TA1314 – Lens amber

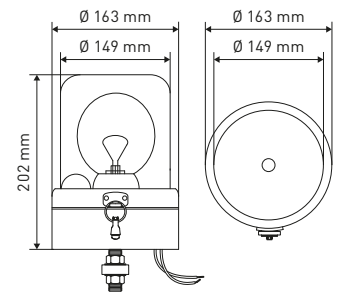

TOTAL SOURCE®

HALOGEN ROTATING BEACONS

REF 151TA3789 – Without bulb

REF 151TA3788 – 12V

- Technology: halogen
- Mounting: magnetic mount
- Wire length: 550 mm
- IP56
- Rotation rate: 180 rotations/minute
- Bulb included
- 12V car plug

REF 123TA8005 – Bulb: H1 12V 55W

REF 151TA3790 – Lens amber

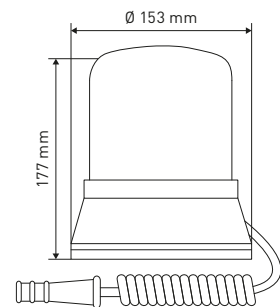

TOTAL SOURCE®

E-approved

REF 151TA3785 – 12V

- Technology: halogen
- Mounting: magnetic mount and suction cap
- Wire length: 670 mm
- Bulb included
- 12V car plug

REF 123TA8005 – Bulb: H1 12V 55W

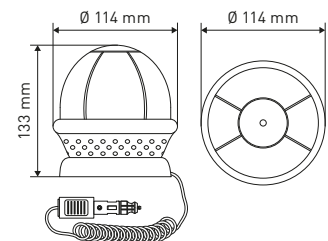

TOTAL SOURCE®

E-approved



HALOGEN BEACONS

REF [151TA3784](#)

- Technology: halogen
- 12-24V
- Mounting: magnetic mount and suction cap
- Wire length: 650 mm
- IP65
- Bulb included
- 12V car plug

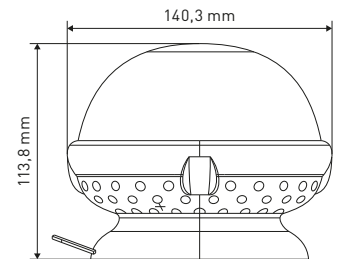

REF [151TA2311](#) – Bulb: BAY9S 12V 21W

REF [151TA2312](#) – Bulb: BAY9S 24V 21W

E-approved

TOTAL SOURCE[®]

REF [151TA3791](#) – 12V

- Technology: halogen
- Mounting: magnetic mount
- Wire length: 650 mm
- IP54
- Rotation rate: 160 ± 30 rotations/minute
- Bulb included
- 12V car plug

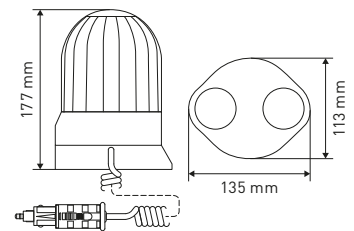

REF [123TA8005](#) – Bulb: H1 12V 55W

E-approved

SIRENA s.p.a.

LED ROTATING BEACONS

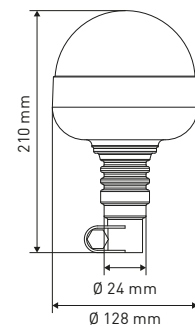

REF [149TA2683](#) – 10-30V

- Technology: LED
- Mounting: pole mount
- 3 selectable flash patterns: rotating, double and quad flash

TOTAL SOURCE[®]



LED ROTATING BEACONS

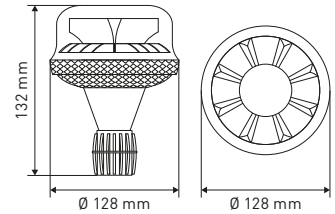

REF 149TA5331 – 10-30V

- Technology: LED
- Mounting: pole mount
- IP6K9K

TOTAL SOURCE[®]

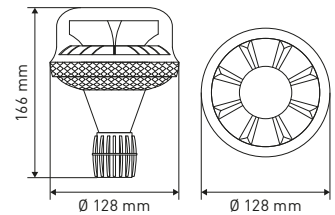

REF 149TA5303 – 10-30V

- Technology: LED
- Mounting: pole mount

E-approved

TOTAL SOURCE[®]

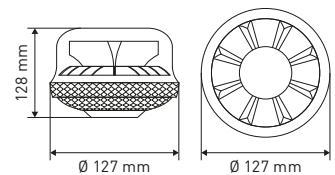

REF 164TA1465 – 10-30V

- Technology: LED
- Mounting: pole mount

E-approved

TOTAL SOURCE[®]



LED FLASHING BEACONS

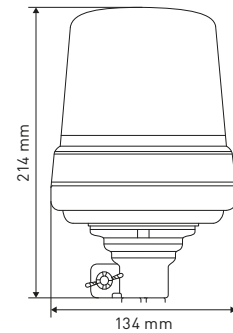

REF 151TA3800 – 12-48V

- Technology: LED
- Mounting: pole mount
- IP69
- Flash rate: 65 flashes/minute

TOTAL SOURCE[®]

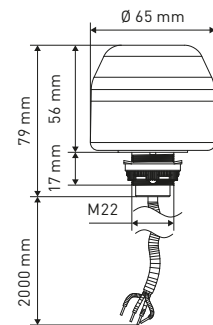

REF 151TA3793 – 12V

- Technology: LED
- Mounting: on socket
- IP65
- Flash rate: 60 flashes/minute

TOTAL SOURCE[®]



XENON FLASHING BEACONS

REF 151TA3781 – 12-80V

- Technology: xenon
- Mounting: central bolt
- Wire length: 230 mm
- IP67
- Flash rate: 75 flashes/minute
- Flash tube included

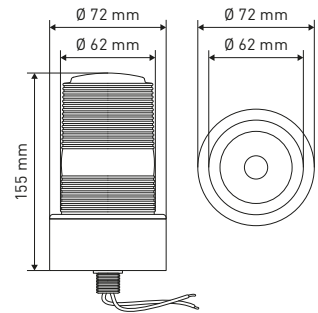

REF 126TA6121 – Flash tube

Made in USA

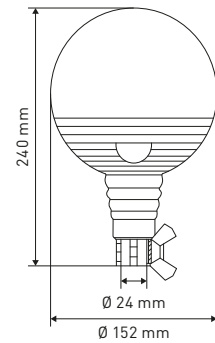

REF 151TA3809 – 12V

- Technology: xenon
- Mounting: pole mount
- IP55
- Flash rate: 140 ± 10 flashes/minute

REF 151TA3810 – Lens amber





HALOGEN ROTATING BEACONS

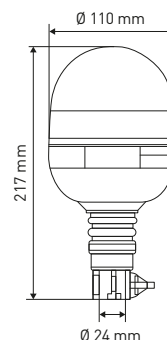

REF 151TA3792 – 12V

- Technology: halogen
- Mounting: pole mount
- IP55
- Rotation rate: 160 ± 30 rotations/minute

REF 123TA8005 – Bulb: H1 12V 55W

TOTAL SOURCE[®]

REF 151TA3794 – Amber

- Technology: halogen
- 12–24V
- Mounting: central bolt M10
- Wire length: 160 mm
- IP56
- Rotation rate: 180 rotations/minute
- Bulb not included
- Connector: 1 x A1, 1 x G1

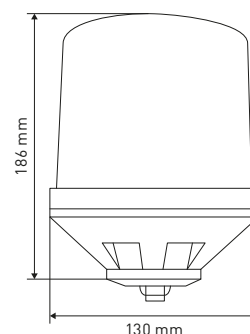

REF 100TA2093 – Bulb: H1 12V 55W

REF 123TA8006 – Bulb: H1 24V 70W

REF 151TA3795 – Lens amber

REF 151TA3796 – Lens green

E-approved

TOTAL SOURCE[®]

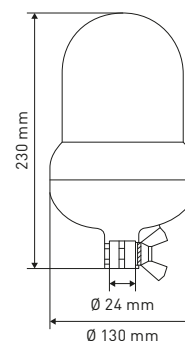

REF 151TA3797 – 12V

- Technology: halogen
- Mounting: pole mount
- IP54
- Rotation rate: 160 rotations/minute
- Bulb included

REF 123TA8005 – Bulb: H1 12V 55W

E-approved

SIRENA s.p.a.



HALOGEN ROTATING BEACONS

REF 151TA3802

- Technology: halogen
- Mounting: pole mount
- IP55
- Rotation rate: 160 rotations/minute
- 12-24V
- Bulb not included

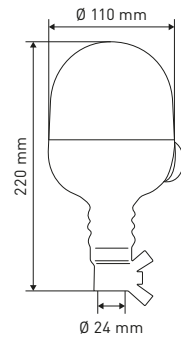

REF 123TA8005 – Bulb: H1 12V 55W

REF 123TA8006 – Bulb: H1 24V 70W



REF 151TA3746 – 24V

- Technology: halogen
- Mounting: pole mount
- IP54
- Rotation rate: 160 ± 20 rotations/minute
- Bulb included

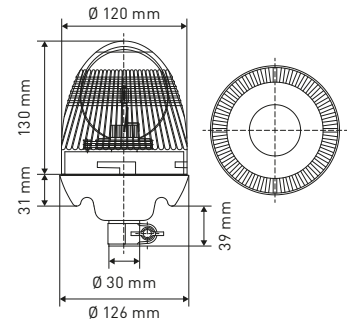

REF 161TA6085 – Bulb: H1 24V 70W

REF 150TA4721 – Lens amber

E-approved



REF 151TA3805 – 12V amber

REF 151TA3806 – 12V red

- Technology: halogen
- Mounting: pole mount
- IP54
- Rotation rate: 160 ± 20 rotations/minute
- Bulb included

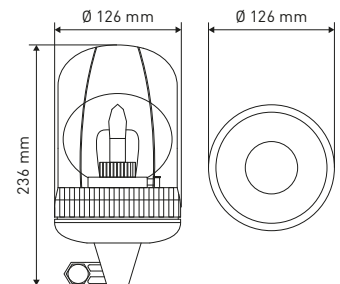

REF 123TA8005 – Bulb: H1 12V 55W

REF 151TA3807 – Lens amber

REF 150TA3214 – Lens red

E-approved





HALOGEN ROTATING BEACONS

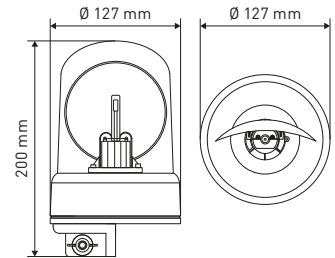

- REF 151TA3801** – 12V
- Technology: halogen
 - Mounting: pole mount
 - Bulb included

REF 123TA8005 – Bulb: H1 12V 55W

E-approved

TOTAL SOURCE®

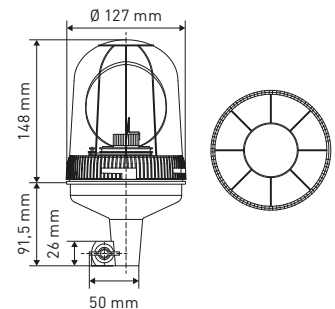

- REF 151TA3808**
- Technology: halogen
 - Mounting: pole mount
 - 12–24V
 - IP54
 - Rotation rate: 160 ± 20 rotations/minute
 - Bulb not included

REF 161TA5353 – Bulb: H1 12V 55W

REF 161TA6085 – Bulb: H1 24V 70W

E-approved

TOTAL SOURCE®

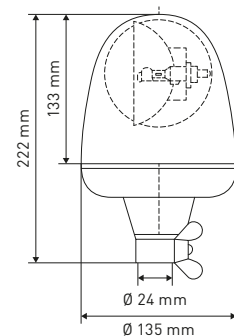

- REF 151TA3803** – 24V
- Technology: halogen
 - Mounting: pole mount
 - IP5K4K, IPX9K
 - Rotation rate: 160 rotations/minute
 - Bulb included

REF 123TA8006 – Bulb: H1 24V 70W

E-approved





HALOGEN ROTATING BEACONS

REF 151TA3811 – Without bulb

REF 151TA3812 – 12V

REF 151TA3813 – 24V

- Technology: halogen
- Mounting: pole mount
- IP66
- Rotation rate: 160 ± 30 rotations/minute
- Flexible

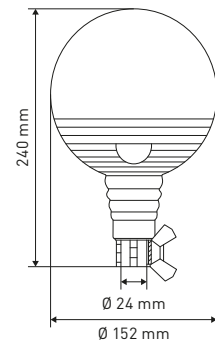

REF 123TA8005 – Bulb: H1 12V 55W

REF 123TA8006 – Bulb: H1 24V 70W

E-approved



REF 151TA3804 – 12V

- Technology: halogen
- Mounting: pole mount
- IP54
- Rotation rate: 160 rotations/minute
- Bulb included

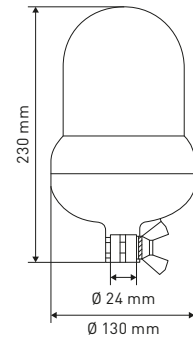

REF 123TA8005 – Bulb: H1 12V 55W

E-approved





XENON FLASHING LIGHT BARS

REF [151TA3821](#) – 12-24V

- Technology: xenon
- Mounting: magnetic mount
- Wire length: 755 mm
- IP54
- 12V car plug
- Flash rate: 75 ± 10 flashes/minute
- Flash tubes included

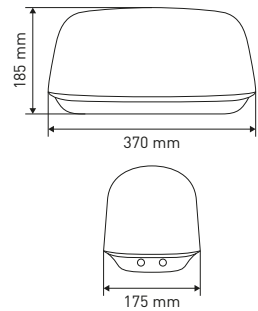

REF [151TA3706](#) – Flash tube

TOTAL SOURCE[®]

REF [151TA3818](#) – 12-24V

- Technology: xenon
- Mounting: magnetic mount
- Wire length: 755 mm
- IP54
- 12V car plug
- Flash rate: 75 ± 10 flashes/minute
- Flash tubes not replaceable

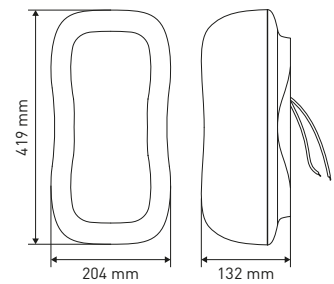

TOTAL SOURCE[®]



HALOGEN LIGHT BARS

REF 151TA3816 – 12V

REF 151TA3817 – 24V

- Technology: halogen
- Mounting: magnetic mount
- Wire length: 3035 mm
- IP54
- 12V car plug
- Rotation rate: 75 ± 10 rotations/minute
- Bulbs included

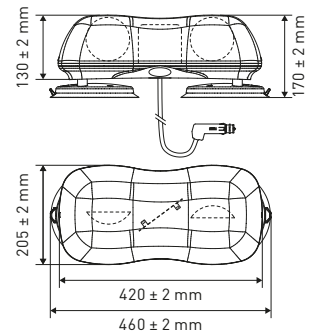

REF 123TA8005 – Bulb: H1 12V 55W

REF 123TA8006 – Bulb: H1 24V 70W

E-approved

TOTAL SOURCE[®]

REF 151TA3819 – 12V

REF 151TA3820 – 24V

- Technology: halogen
- Mounting: central bolt
- Wire length: 220 mm
- IP54
- 12V car plug
- Rotation rate: 160 rotations/minute
- Bulbs included

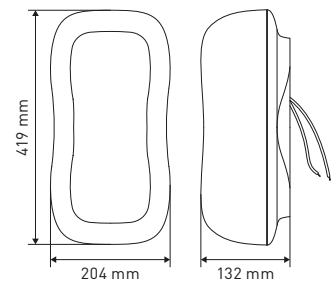

REF 123TA8005 – Bulb: H1 12V 55W

REF 123TA8006 – Bulb: H1 24V 70W

E-approved

TOTAL SOURCE[®]



MAGNETIC LED STROBE LIGHT

1 REF 151TA3829

- Non-rechargeable version
- Powered by battery CR123A (REF 151TA3830)

REF 151TA3832

Rechargeable light without charger

2 REF 151TA3831

Rechargeable version, universal charger included

3 REF 151TA3833

- Case with 6 pieces
- Rechargeable (case recharges all 6 LED lights simultaneously)

Characteristics:

- Height: 34 mm
- Ø 106,50 mm
- 9 different flashing patterns
- Shock-resistant
- Magnetic
- Water-resistant
- With universal charger

These lights can quickly and easily be deployed in case of:

- Works on and along the road
- Vehicle breakdown
- Loading and unloading of a vehicle
- Events



TOTAL SOURCE®

XENON EX-PROOF STROBE

REF 151TA3631 – 12-48V

- Technology: xenon
- Mounting: screws
- Length: 80 mm
- With: 75 mm
- Height: 260 mm
- IP66
- Ex-proof
- EX II 2 G, EX II 2 D
- Bulb not replaceable

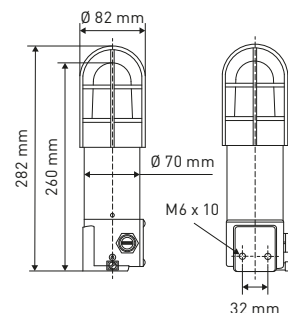

REF 151TA3632 – Support

REF 151TA3633 – Protection grill



TOTAL SOURCE®



ADAPTER SOCKET "WELDING"



REF [106TA9131](#)

ADAPTER SOCKET "SCREW-IN"



REF [106TA9132](#)

TELESCOPIC ARM

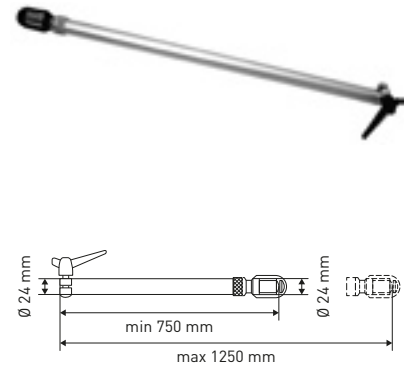

REF [106TA9177](#)

ADAPTER SOCKET

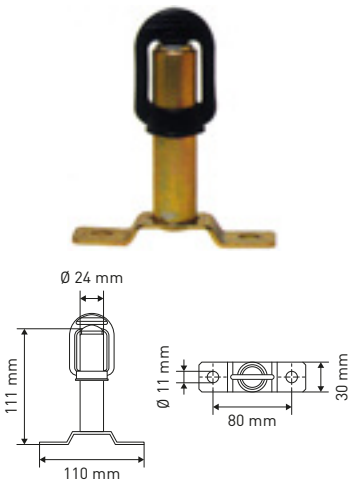

REF [106TA9176](#)

ADAPTER SOCKET

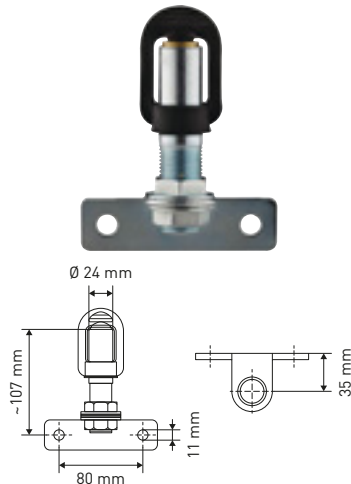

REF [126TA6019](#)

CORNER ADAPTER SOCKET

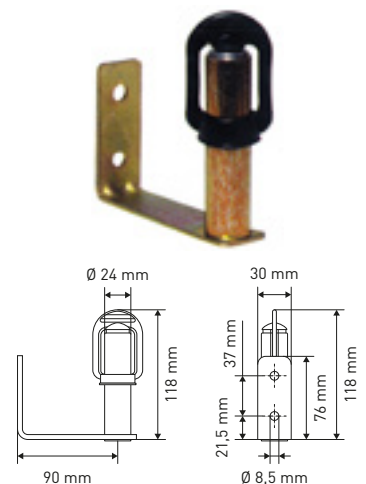

REF [106TA9175](#)

ADJUSTABLE ADAPTER SOCKET

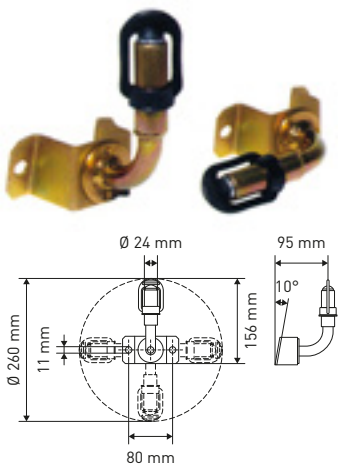

REF [106TA9174](#)

ADAPTER SOCKET



REF [131TA8886](#)

ADAPTER SOCKET "FLEXIBLE"



REF [140TA8763](#)



REAR LIGHTS



NICE TO KNOW – REAR LIGHTS



The primary function of a rear light is to alert potential following vehicles of the presence on the road. To do so, a light with a red appearance is used: the red colour remains the most visible in all weather conditions. A second important function is to inform surrounding vehicles and persons of upcoming changes in direction.

Rear lights can have a single function or can also combine multiple functions in 1 light: a rear light, stop light, indicator light, reverse light, fog light and even number plate lighting.

Different technologies are available:

- rear lights with LED technology
- rear lights with incandescent bulbs

In some countries there is a requirement to have a red reflective triangle as part of the rear light for use on public roads.

Rear lights with bulb technology can be available in different voltages. These are according to the original products.

The rear lights with turn indicator are not equipped with an electronic flasher unit. Depending on the used technology of the light there is another flasher unit needed.

REF 164TA9406 is a perfect flasher unit for 12–24V turn indicators with bulb technology.

REF 164TA9407 is compact flasher unit for LED turn indicators between 12–24V.



REVERSE/FOG LIGHT

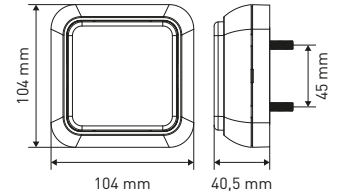

REF 148TA3523 – 12-24V

- Technology: LED
- Mounting: 2 bolts
- Center distance: 45 mm
- Wire length: 190 mm
- Function: reverse

E-approved

TOTAL SOURCE[®]

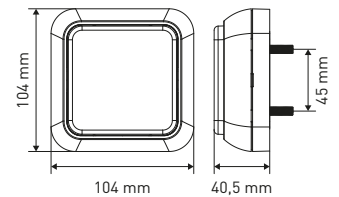

REF 148TA3524 – 12-24V

- Technology: LED
- Mounting: 2 bolts
- Center distance: 45 mm
- Wire length: 190 mm
- Function: fog

E-approved

TOTAL SOURCE[®]



REVERSE/FOG LIGHT

REF 151TA5985

- Technology: incandescent
- Mounting: 2 bolts
- Center distance: 45 mm
- 12-24V
- Function: reverse
- Bulb not included

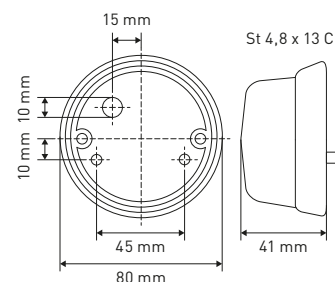

REF 103TA4541 – Bulb: SV8,5-8 12V 18W

REF 106TA4833 – Bulb: SV8,5-8 24V 18W



E-approved

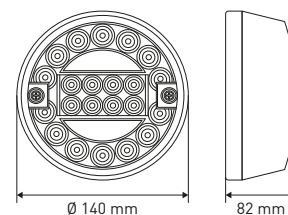

REF 163TA8808 – 12-24V

- Technology: LED
- Mounting: 2 bolts
- Center distance: 45 mm
- Function: fog

E-approved

TOTAL SOURCE[®]

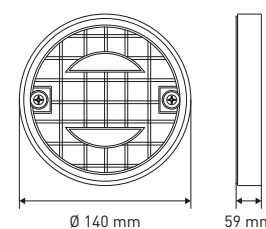

REF 163TA8809 – 12-24V

- Technology: LED
- Mounting: 2 bolts
- Center distance: 45 mm
- Function: reverse

E-approved

TOTAL SOURCE[®]



REAR LIGHTS

- REF 151TA5968** – LH
REF 151TA5969 – RH + number plate light
- Technology: LED
 - Mounting: 2 bolts
 - Center distance: 60 mm
 - Wire length: 480 mm
 - 10–30V
 - Functions LH: rear, stop, turn
 - Functions RH: rear, stop, turn, license

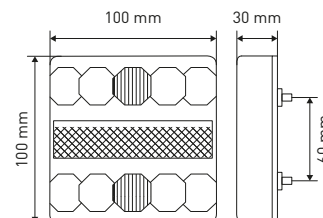

E-approved

TOTAL SOURCE[®]

- REF 163TA8804** – 12–24V
- Technology: LED
 - Mounting: 2 bolts
 - Center distance: 55 mm
 - Functions: rear, stop, turn, license

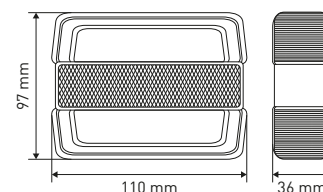

E-approved

TOTAL SOURCE[®]

- REF 151TA5970** – 12–24V
- Technology: LED
 - Mounting: 2 bolts
 - Center distance: 100 mm
 - Wire length: 1500 mm
 - Bulb not replaceable
 - Functions: rear, stop, turn

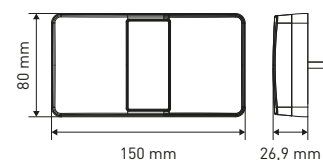

E-approved

TOTAL SOURCE[®]



REAR LIGHTS

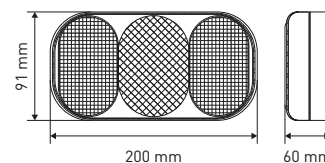

REF 151TA6026 – 12-24V

- Technology: LED
- Mounting: 2 bolts
- Center distance: 195 mm
- Functions: rear, stop, turn

E-approved

TOTAL SOURCE®

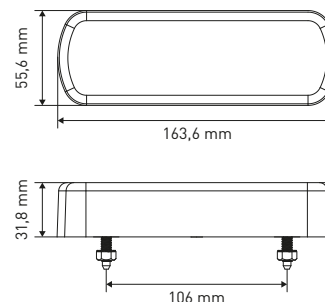

REF 151TA5956 – 12-24V horizontal mount

REF 151TA5957 – 12-24V vertical mount

- Technology: LED
- Mounting: 2 bolts
- Center distance: 106 mm
- Wire length: 1500 mm
- Functions: rear, stop, turn

E-approved

TOTAL SOURCE®

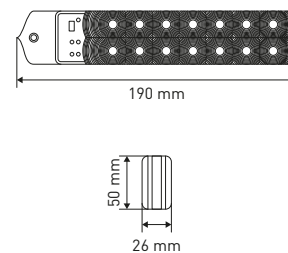

REF 151TA5958 – 12V

- Technology: LED
- Mounting: 2 bolts
- Center distance: 170 mm
- Functions: rear, stop, turn, reverse
- Connector: E6 built-in

TOTAL SOURCE®



REAR LIGHTS

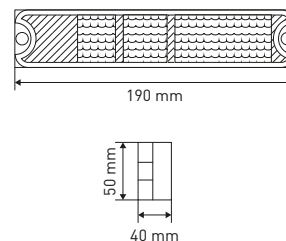

- REF 151TA5965** – 12V
- Technology: LED
 - Mounting: 2 bolts
 - Center distance: 170 mm
 - Functions: rear, stop, turn
 - Connector: O6 built-in

E-approved

TOTAL SOURCE[®]
BRAND: SPEAKER

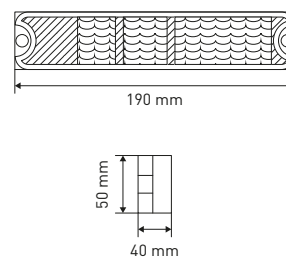

- REF 151TA6040** – 12V
- Technology: LED
 - Mounting: 2 bolts
 - Center distance: 170 mm
 - Functions: rear, stop, turn
 - Connector: A6

TOTAL SOURCE[®]

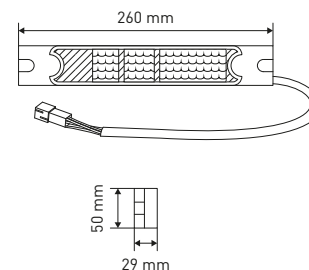

- REF 151TA5966** – 12V
- Technology: LED
 - Mounting: 2 bolts
 - Center distance: 238 mm
 - Wire length: 520 mm
 - Functions: rear, stop, turn, reverse
 - Connector: O6

TOTAL SOURCE[®]



REAR LIGHTS

REF 134TA3713 – 12V single LED light

REF 134TA3714 – 24V single LED light

- Technology: LED
- Mounting: 2 bolts
- Center distance: 195 mm
- Wire length: 3000 mm
- Functions: rear, stop, turn, reverse

E-approved

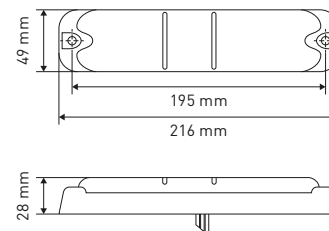

TOTAL SOURCE[®]
BRAND: SPEAKER

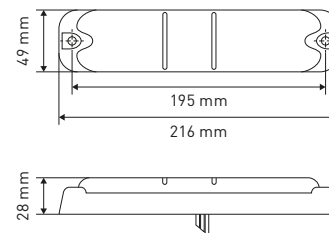

REF 151TA5964 – 9-56V

- Technology: LED
- Mounting: 2 bolts
- Center distance: 195 mm
- Wire length: 215 mm
- Functions: rear, stop, turn, reverse
- Connector: C6

TOTAL SOURCE[®]

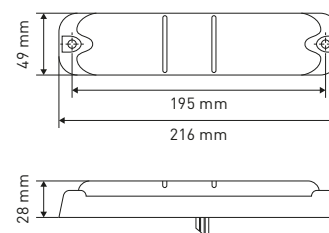

REF 151TA6030 – Kit: 2 lights + flasher

- Technology: LED
- Mounting: 2 bolts
- Center distance: 195 mm
- Wire length: 310 mm
- Functions: rear, stop, turn, reverse

REF 151TA6028 – 9-56V

REF 151TA6029 – Flasher

TOTAL SOURCE[®]



REAR LIGHTS

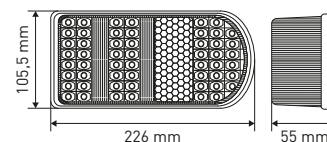

REF 163TA8806 – 12-24V LH

REF 163TA8805 – 12-24V RH

- Technology: LED
- Mounting: 2 bolts M6
- Center distance: 150 mm
- Functions LH: rear, stop, turn, fog, license
- Functions RH: rear, stop, turn, reverse, license

E-approved

TOTAL SOURCE®



LH



RH

REF 148TA3521 – 12-24V LH

REF 148TA3522 – 12-24V RH

- Technology: LED
- Mounting: 2 bolts
- Center distance: 152 mm
- Functions LH: rear, stop, turn, fog, license
- Functions RH: rear, stop, turn, reverse, license, reflector triangle

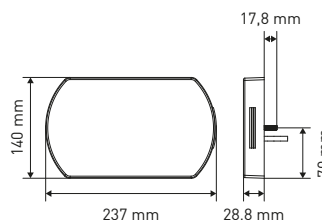

E-approved

TOTAL SOURCE®



LH



RH

REF 148TA3526 – 12-24V LH

REF 148TA3527 – 12-24V RH

- Technology: LED
- Mounting: 2 bolts
- Center distance: 152 mm
- Functions: rear, stop, turn, fog, reflector

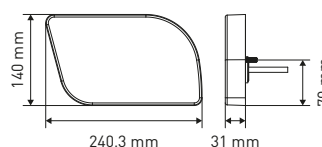

E-approved

TOTAL SOURCE®



REAR LIGHTS

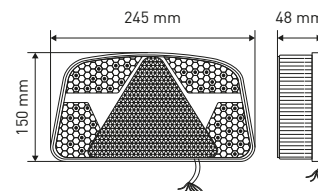

REF 163TA8803 – 12 LH

REF 163TA8802 – 12V RH

- Technology: LED
- Mounting: 2 bolts M6
- Center distance: 152 mm
- Functions: rear, stop, turn, reverse, fog, license, reflector triangle

E-approved

TOTAL SOURCE®

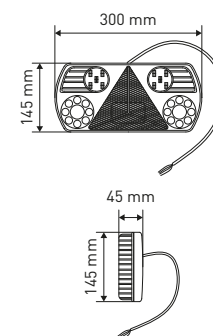

REF 163TA8801 – 12-24V LH

REF 163TA8800 – 12-24V RH

- Technology: LED
- Mounting: 2 bolts
- Center distance: 152 mm
- Functions LH: rear, stop, turn, fog, license, reflector triangle
- Functions RH: rear, stop, turn, reverse, license, reflector triangle

E-approved

TOTAL SOURCE®

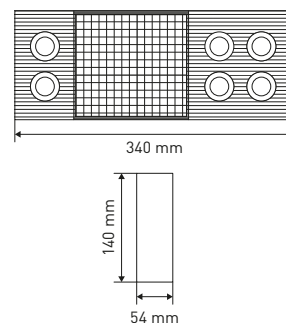

REF 151TA5972 – 12-24V LH

REF 151TA5971 – 12-24V RH

- Technology: LED
- Mounting: 2 bolts
- Center distance: 152 mm
- Functions: rear, stop, turn, reverse, DI, reflex
- Connector: A7, 2 x E2 built-in

E-approved

TOTAL SOURCE®



REAR LIGHTS

REF 151TA5993

- Technology: incandescent
- Mounting: 2 bolts
- Center distance: 45 mm
- 12-24V
- Functions: rear, stop, turn
- Bulbs not included

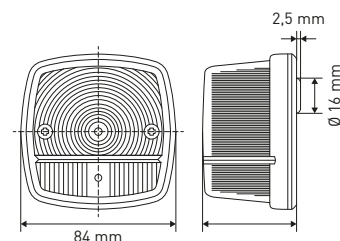

REF 103TA4537 – Bulb: SV8,5-8 12V 5W

REF 100TA2215 – Bulb: BA15S 12V 21W

REF 103TA4539 – Bulb: SV8,5-8 24V 5W

REF 103TA4603 – Bulb: BA15S 24V 21W



E-approved

REF 151TA5996

- Technology: incandescent
- Mounting: 2 bolts
- Center distance: 45 mm
- 12-24V
- Functions: stop
- Bulbs not included

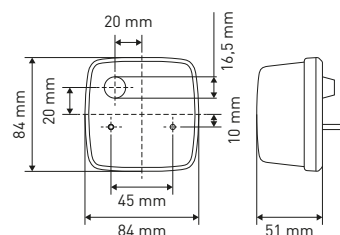

REF 103TA4537 – Bulb: SV 8,5-8 12V 5W

REF 100TA2215 – Bulb: BA15S 12V 21W

REF 103TA4539 – Bulb: SV8,5-8 24V 5W

REF 103TA4603 – Bulb: BA15S 24V 21W

REF 151TA5997 – Replacement lens red



E-approved

REF 151TA5998 – LH

REF 151TA5999 – RH

- Technology: incandescent
- Mounting: 2 bolts
- Center distance: 45 mm
- 12V
- Functions: rear, stop, turn
- Bulbs not included

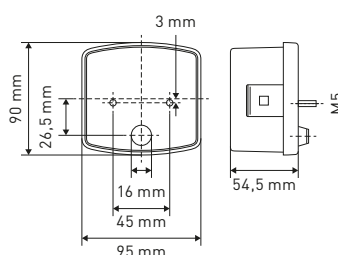

REF 103TA4596 – Bulb: BA15S 12V 10W

REF 100TA2215 – Bulb: BA15S 12V 21W

REF 151TA6000 – Replacement lens LH

REF 144TA1690 – Replacement lens RH



E-approved



REAR LIGHTS

REF 151TA5988 – LH
REF 151TA5989 – RH

- Technology: incandescent
- Mounting: 2 bolts
- Center distance: 45 mm
- Horizontal and vertical mount
- 12–24V
- Functions: rear, stop, turn
- Bulbs not included

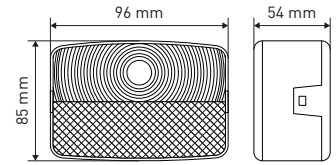

REF 123TA7983 – Bulb: BA15S 12V 10W
REF 100TA2215 – Bulb: BA15S 12V 21W
REF 123TA7984 – Bulb: BA15S 24V 10W
REF 103TA4603 – Bulb: BA15S 24V 21W
REF 151TA5990 – Replacement lens

E-approved



REF 151TA5995

- Technology: incandescent
- Mounting: 2 bolts
- Center distance: 45 mm
- Horizontal & vertical mount
- 12–24V
- Functions: rear, stop, turn, license
- Bulbs not included

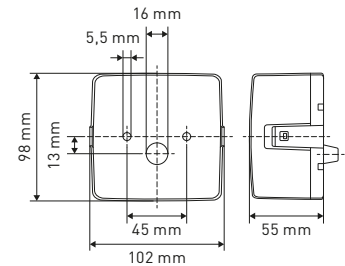

REF 103TA4596 – Bulb: BA15S 12V 10W
REF 100TA2215 – Bulb: BA15S 12V 21W
REF 100TA2195 – Bulb: BA15S 24V 10W
REF 100TA2218 – Bulb: BA15S 24V 21W
REF 150TA3817 – Replacement lens

E-approved



REF 151TA5986

- Technology: incandescent
- Mounting: 2 bolts
- Center distance: 45 mm
- 12–24V
- Functions: rear, stop, turn, license
- Bulbs not included

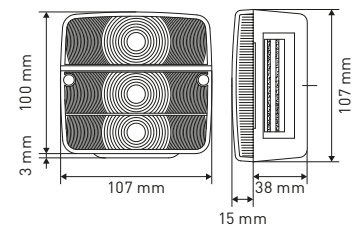

REF 100TA2215 – Bulb: BA15S 12V 21W
REF 103TA4621 – Bulb: BAY15D 12V 21/5W
REF 106TA4830 – Bulb: SV8,5 12V 5W
REF 103TA4603 – Bulb: BA15S 24V 21W
REF 106TA4875 – Bulb: BAY15D 24V 21/5W
REF 106TA4540 – Bulb: SV8,5 24V 5W
REF 151TA5987 – Replacement lens

E-approved

TOTAL SOURCE®

BRAND: A.J.B.A



REAR LIGHTS

REF 151TA6058

- Technology: incandescent
- Mounting: 2 bolts
- Center distance: 45 mm
- 12-24V
- Functions: rear, stop, turn, license
- Bulbs not included

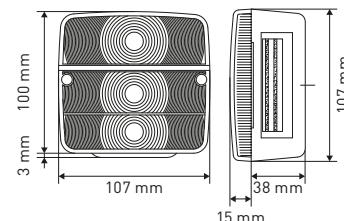

- REF [100TA2215](#) – Bulb: BA15S 12V 21W
- REF [103TA4621](#) – Bulb: BAY15D 12V 21/5W
- REF [103TA4603](#) – Bulb: BA15S 24V 21W
- REF [106TA4875](#) – Bulb: BAY15D 24V 21/5W
- REF [151TA5987](#) – Replacement lens

E-approved

TOTAL SOURCE®

REF 151TA6059

- Technology: incandescent
- Mounting: 2 bolts
- Center distance: 45 mm
- 12-24V
- Functions: rear, stop, turn
- Bulbs not included

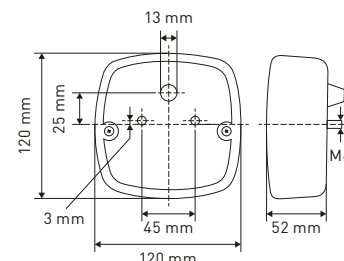

- REF [103TA4596](#) – Bulb: BA15S 12V 10W
- REF [100TA2215](#) – Bulb: BA15S 12V 21W
- REF [100TA2195](#) – Bulb: BA15S 24V 10W
- REF [100TA2218](#) – Bulb: BA15S 24V 21W
- REF [150TA3812](#) – Replacement lens

E-approved



REF 151TA5992

- Technology: incandescent
- Mounting: 2 bolts
- Center distance: 45 mm
- 12-24V
- Functions: rear, stop, turn, license
- Bulbs not included

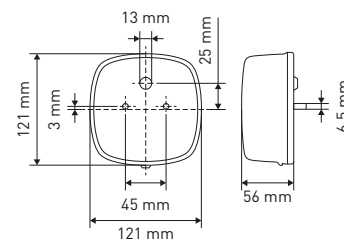

- REF [123TA7983](#) – Bulb: BA15S 12V 10W
- REF [100TA2215](#) – Bulb: BA15S 12V 21W
- REF [123TA7984](#) – Bulb: BA15S 24V 10W
- REF [103TA4603](#) – Bulb: BA15S 24V 21W
- REF [106TA1280](#) – Replacement lens

E-approved





REVERSE LIGHT

REF 151TA6002

- Technology: incandescent
- Mounting: 2 bolts
- Center distance: 45 mm
- 12-24V
- Function: reverse
- Bulbs not included

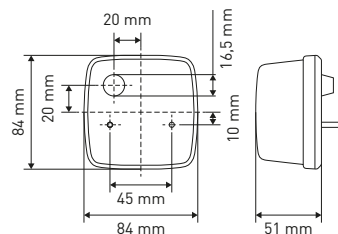

- REF 103TA4537** – Bulb: SV 8,5-8 12V 5W
- REF 100TA2215** – Bulb: BA15S 12V 21W
- REF 103TA4539** – Bulb: SV8,5-8 24V 5W
- REF 103TA4603** – Bulb: BA15S 24V 21W
- REF 151TA6001** – Replacement lens white



E-approved

REF 151TA6003

- Technology: incandescent
- Mounting: 2 bolts
- Center distance: 45 mm
- 12-24V
- Function: reverse
- Bulbs not included

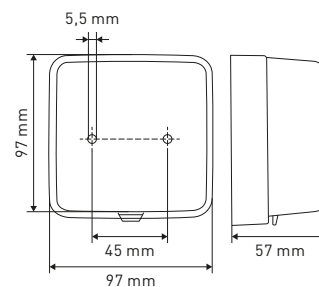

- REF 100TA2215** – Bulb: BA15S 12V 21W
- REF 103TA4603** – Bulb: BA15S 24V 21W



E-approved



REAR LIGHTS

REF [151TA6031](#) – 12V

- Technology: incandescent
- Mounting: 2 bolts
- Center distance: 58 mm
- Functions: rear, brake, turn
- Bulbs included

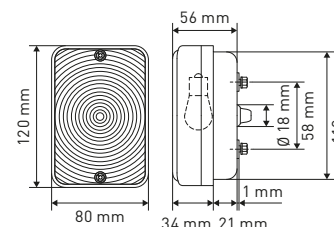

- REF [100TA2215](#) – Bulb: BA15S 12V 21W
- REF [100TA2246](#) – Bulb: BAY15D 12V 21/5W
- REF [151TA6033](#) – Replacement lens



E-approved

REF [151TA6106](#) – 12V

- Technology: incandescent
- Mounting: pedestal
- Wire length: 300 mm
- Function: fog
- Bulb included
- Connector: F2

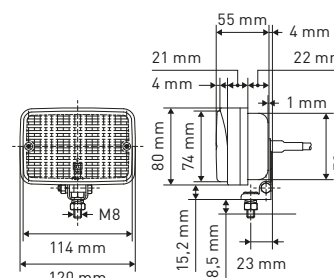

- REF [100TA2215](#) – Bulb: BA15S 12V 21W



REF [151TA5973](#) – 24V LH

REF [151TA5974](#) – 24V RH

- Technology: incandescent
- Mounting: 2 bolts
- Center distance: 88 mm
- Wire length: 80 mm
- Functions: rear, stop, reverse
- Bulbs included
- Connector: K4

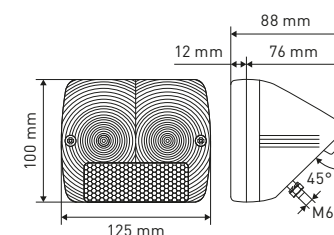

- REF [100TA2218](#) – Bulb: BA15S 24V 21W
- REF [100TA2249](#) – Bulb: BAY15D 24V 21/5W
- REF [150TA3126](#) – Replacement lens LH
- REF [150TA3127](#) – Replacement lens RH



E-approved



REAR LIGHTS

REF 151TA6081 – 12V

- Technology: incandescent
- Mounting: 2 bolts
- Functions: rear, stop, turn
- Bulbs included

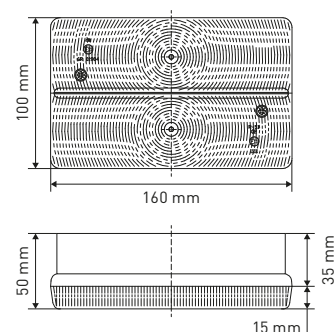

- REF 100TA2215 – Bulb: BA15S 12V 21W
- REF 103TA4621 – Bulb: BAY15D 12V 21/5W
- REF 150TA4534 – Replacement lens

E-approved

TOTAL SOURCE®
BRAND: BRITAX

REF 151TA5921 – 12V

- REF 151TA5922 – 24V
- Technology: incandescent
- Mounting: 2 bolts
- Center distance: 160 mm
- Wire length: 500 mm
- Functions: rear, stop, reverse
- Bulbs included
- Connector: B4

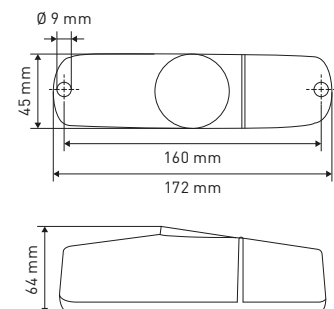

- REF 100TA2119 – Bulb: S8,5 12V 10W
- REF 106TA4904 – Bulb: BAY15D 12V 23/8W
- REF 123TA7984 – Bulb: BA15S 24V 10W
- REF 100TA2250 – Bulb: BAY15D 24V 25/10W
- REF 150TA1265 – Replacement lens white
- REF 150TA1262 – Replacement lens red

TOTAL SOURCE®

REF 151TA6015 – 48V

- Technology: incandescent
- Mounting: 2 bolts
- Center distance: 160,5 mm
- Wire length: 295 mm
- Functions: rear, stop, turn
- Bulbs included
- Connector: B4

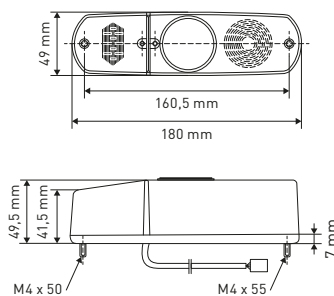

- REF 123TA7986 – Bulb: BAY15D 48V 10W
- REF 123TA7990 – Bulb: BAY15D 48V 25/10W
- REF 150TA1263 – Replacement lens red
- REF 150TA1276 – Replacement lens clear

TOTAL SOURCE®



REAR LIGHTS

- REF 151TA5923** – 12V
- Technology: incandescent
 - Mounting: 2 bolts
 - Center distance: 176 mm
 - Wire length: 430 mm
 - Functions: rear, stop, reverse
 - Bulbs included
 - Connector: C4

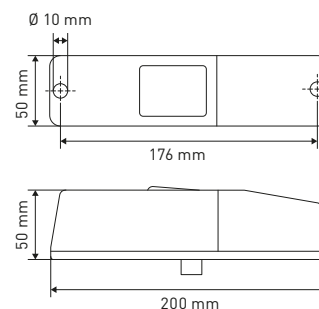

- REF 100TA2215** – Bulb: BA15S 12V 21W
REF 100TA2246 – Bulb: BAY15D 12V 21/5W
REF 151TA3896 – Replacement lens

TOTAL SOURCE®

- REF 151TA3918** – 48V wire length: 160 mm
connector: H6
- REF 151TA3895** – 48V wire length: 520 mm
connector: C4
- Technology: incandescent
 - Mounting: 2 bolts
 - Center distance: 176 mm
 - Wire length: 160 mm
 - Functions: rear, stop
 - Bulbs included

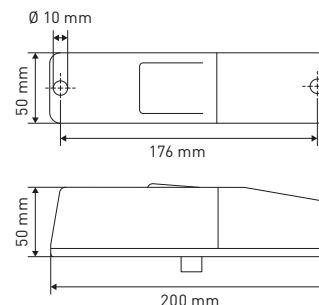

- REF 103TA4598** – Bulb: BAY15D 48V 10W
REF 106TA4877 – Bulb: BAY15D 48V 25/10W
REF 151TA3896 – Replacement lens
REF 151TA3919 – Replacement housing

TOTAL SOURCE®

- REF 151TA3910** – 12V
- Technology: incandescent
 - Mounting: 2 bolts
 - Center distance: 176 mm
 - Wire length: 430 mm
 - Functions: rear, stop, turn
 - Bulbs included
 - Connector: D4

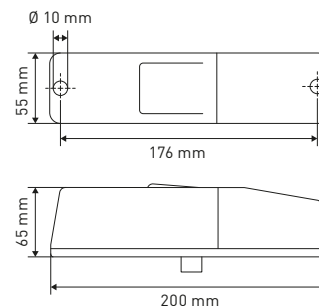

- REF 100TA2215** – Bulb: BA15S 12V 21W
REF 100TA2246 – Bulb: BAY15D 12V 21/5W

TOTAL SOURCE®



REAR LIGHTS

REF [151TA5919](#) – 12V

- Technology: incandescent
- Mounting: 2 bolts
- Center distance: 192 mm
- Wire length: 1000 mm
- Functions: rear, stop, turn, reverse
- Bulbs included
- Connector: A3

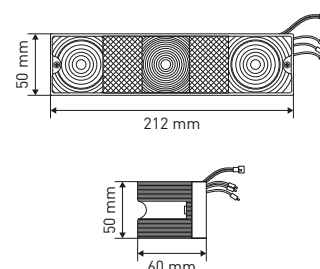

REF [100TA2214](#) – Bulb: BA15S 12V 18W

REF [106TA4904](#) – Bulb: BAY15D 12V 23/8W

REF [150TA9426](#) – Replacement lens kit

TOTAL SOURCE®

REF [151TA5906](#) – 12V

- Technology: incandescent
- Mounting: 2 bolts
- Center distance: 192 mm
- Functions: rear, stop, turn, reverse
- Bulbs included

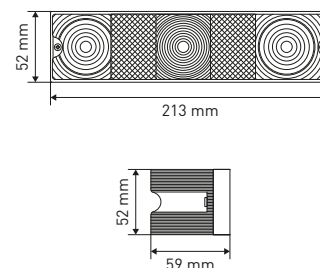

REF [106TA4861](#) – Bulb: BA15S 12V 18W

REF [106TA4904](#) – Bulb: BAY15D 12V 23/8W

REF [150TA9426](#) – Replacement lens kit

REF [151TA5907](#) – Metal guard

TOTAL SOURCE®

REF [151TA3909](#) – 24V

- Technology: incandescent
- Mounting: 2 bolts
- Center distance: 192 mm
- Wire length: 180 mm
- Functions: rear, stop, turn, reverse
- Bulbs included
- Connector: B6

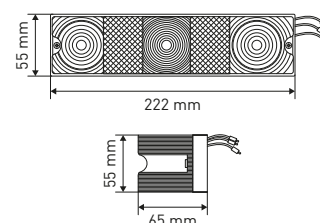

REF [123TA7984](#) – Bulb: BA15S 24V 10W

REF [100TA2249](#) – Bulb: BAY15D 24V 21/5W

REF [103TA4603](#) – Bulb: BA15S 24V 21W

REF [151TA3894](#) – Replacement lens

TOTAL SOURCE®



REAR LIGHTS



REF 151TA3916 – 24V

- Technology: incandescent
- Mounting: 2 bolts
- Center distance: 192 mm
- Wire length: 500 mm
- Functions: rear, stop, turn, reverse
- Bulbs included
- Connector: O6

- REF 123TA7984** – Bulb: BA15S 24V 10W
- REF 100TA2250** – Bulb: BAY15D 24V 25/10W
- REF 100TA2219** – Bulb: BA15S 24V 25W
- REF 151TA3917** – Replacement lens kit

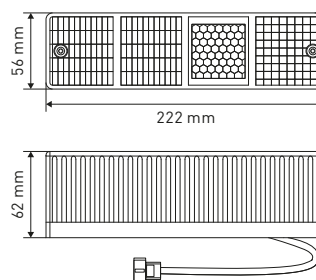

TOTAL SOURCE®



REF 151TA6027 – 12V

- Technology: incandescent
- Mounting: 2 bolts
- Center distance: 192 mm
- Wire length: 900 mm
- Functions: rear, stop, turn, reverse
- Bulbs included
- Connector: A3

- REF 106TA1277** – Bulb: BA15S 12V 10W
- REF 100TA2246** – Bulb: BAY15D 12V 21/5W
- REF 100TA2215** – Bulb: BA15S 12V 21W
- REF 151TA3894** – Replacement lens

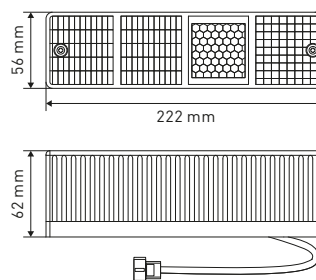

TOTAL SOURCE®



REAR LIGHTS



REF 151TA5916 – 12V

REF 151TA5917 – 24V

REF 151TA5918 – 48V

- Technology: incandescent
- Mounting: 2 bolts
- Center distance: 192 mm
- Wire length: 500 mm
- Functions: rear, stop, turn, reverse
- Bulbs included
- Connector: O6

REF 123TA7983 – Bulb: BA15S 12V 10W

REF 100TA2215 – Bulb: BA15S 12V 21W

REF 100TA2246 – Bulb: BAY15D 12V 21/5W

REF 123TA7984 – Bulb: BA15S 24V 10W

REF 100TA2250 – Bulb: BAY15D 24V 25/10W

REF 100TA2219 – Bulb: BA15S 24V 25W

REF 123TA7986 – Bulb: BAY15D 48V 10W

REF 123TA7990 – Bulb: BAT15D 48V 25/10W

REF 123TA7992 – Bulb: BAY15D 48V 25W

REF 151TA3894 – Replacement lens

REF 123TA7992 – Bulb: BAY15D 48V 25W

REF 151TA3894 – Replacement lens

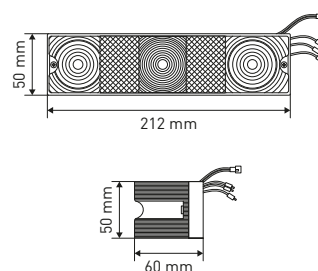

TOTAL SOURCE®



REF 151TA3892 – 24V

- Technology: incandescent
- Mounting: 2 bolts
- Center distance: 192 mm
- Wire length: 205 mm
- Functions: rear, stop, turn, reverse
- Bulbs included
- Connector: B6

REF 123TA7984 – Bulb: BA15S 24V 10W

REF 100TA2249 – Bulb: BAY15D 24V 21/5W

REF 103TA4603 – Bulb: BA15S 24V 21W

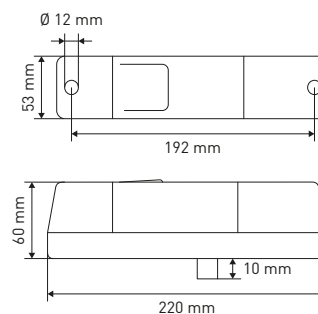

TOTAL SOURCE®



REAR LIGHTS

REF [151TA3893](#) – 48V

- Technology: incandescent
- Mounting: 2 bolts
- Center distance: 192 mm
- Wire length: 250 mm
- Functions: rear, stop, turn, reverse
- Bulbs included
- Connector: F6

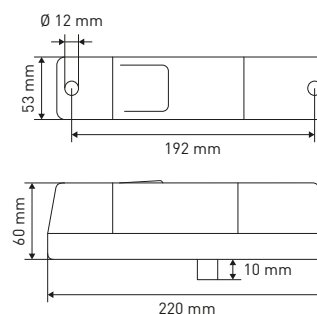

- REF [119TA8919](#) – Bulb: BA15D 48V 10W
- REF [123TA7990](#) – Bulb: BAT15D 48V 25/10W
- REF [123TA7992](#) – Bulb: BAY15D 48V 25W
- REF [151TA3894](#) – Replacement lens

TOTAL SOURCE®

REF [151TA3897](#) – 12V

- REF [151TA3898](#) – 12V wire length: 1230 mm
- Technology: incandescent
- Mounting: 2 bolts
- Center distance: 190 mm
- Functions: rear, stop, turn, reverse
- Bulbs included
- Connector: G6

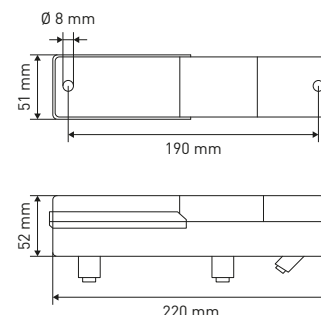

- REF [100TA2191](#) – Bulb: BA15S 12V 10W
- REF [103TA4601](#) – Bulb: BA15S 12V 23W
- REF [106TA4904](#) – Bulb: BAY15D 12V 23/8W
- REF [151TA3899](#) – Replacement lens

TOTAL SOURCE®

REF [151TA3900](#) – 12V

- REF [151TA3901](#) – 24V
- Technology: incandescent
- Mounting: 2 bolts
- Center distance: 190 mm
- Wire length: 500 mm
- Functions: rear, stop, turn, reverse
- Bulbs included
- Connector: D3

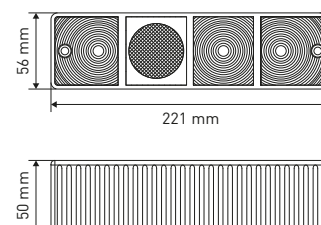

- REF [100TA2191](#) – Bulb: BA15S 12V 10W
- REF [103TA4601](#) – Bulb: BA15S 12V 23W
- REF [106TA4904](#) – Bulb: BAY15D 12V 23/8W
- REF [106TA4860](#) – Bulb: BA15S 10W
- REF [103TA4604](#) – Bulb: BA15S 24V 25W
- REF [103TA4623](#) – Bulb: BAY15D 24V 25/10W
- REF [151TA3902](#) – Replacement lens

TOTAL SOURCE®



REAR LIGHTS

REF [151TA5920](#) – 12V

- Technology: incandescent
- Mounting: 2 bolts
- Center distance: 190 mm
- Wire length: 1020 mm
- Functions: rear, stop, turn, reverse, license
- Bulbs included
- Connector: L6

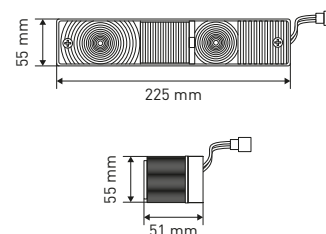

REF [123TA7983](#) – Bulb: BA15S 12V 10W

REF [100TA2215](#) – Bulb: BA15S 12V 21W

REF [123TA7988](#) – Bulb: BAY15D 12V 21/5W

REF [151TA3899](#) – Replacement lens

TOTAL SOURCE®

REF [151TA5908](#) – 12V wire length: 710 mm

REF [151TA5909](#) – 12V wire length: 770 mm

REF [151TA5911](#) – 12V wire length: 1100 mm

REF [151TA5910](#) – 24V wire length: 770 mm

- Technology: incandescent
- Mounting: 2 bolts
- Center distance: 190 mm
- Functions: rear, stop, turn, reverse
- Bulbs included
- Connector: G6

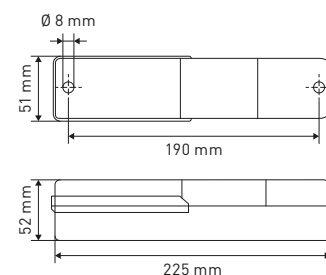

REF [103TA4596](#) – Bulb: BA15S 12V 10W

REF [100TA2215](#) – Bulb: BA15S 12V 21W

REF [123TA7988](#) – Bulb: BAY15D 12V 21/5W

REF [123TA7984](#) – Bulb: BA15S 24V 10W

REF [103TA4603](#) – Bulb: BA15S 24V 21W

REF [103TA4623](#) – Bulb: BAY15D 24V 25/10W

REF [151TA3899](#) – Replacement lens

TOTAL SOURCE®

REF [151TA3908](#) – 12V

- Technology: incandescent
- Mounting: 2 bolts
- Center distance: 190 mm
- Wire length: 185 mm
- Functions: rear, stop, turn, reverse
- Bulbs included
- Used for Hyundai
- Connector: L6

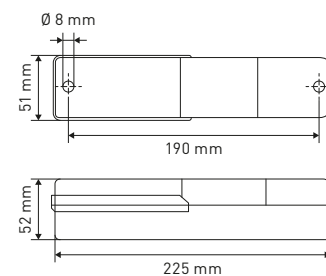

REF [100TA2191](#) – Bulb: BA15S 12V 10W

REF [100TA2215](#) – Bulb: BA15S 12V 21W

REF [100TA2246](#) – Bulb: BAY15D 12V 21/5W

TOTAL SOURCE®



REAR LIGHTS

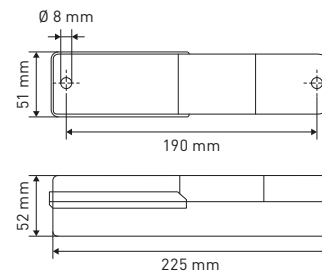

REF 151TA5924 – 12V

- Technology: incandescent
- Mounting: 2 bolts
- Center distance: 190 mm
- Wire length: 180 mm
- Functions: rear, stop, turn, reverse
- Bulbs included
- Connector: N6

REF 100TA2191 – Bulb: BA15S 12V 10W

REF 100TA2215 – Bulb: BA15S 12V 21W

REF 123TA7988 – Bulb: BAY15D 12V 21/5W

TOTAL SOURCE®

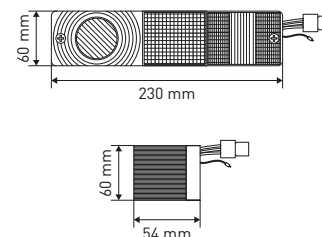

REF 151TA3905 – 12V

REF 151TA3906 – 24V

- Technology: incandescent
- Mounting: 2 bolts
- Center distance: 100 mm
- Wire length: 54 mm
- Functions: rear, stop, turn, reverse
- Bulbs included
- Connector: D4

REF 103TA4596 – Bulb: BA15S 12V 10W

REF 100TA2215 – Bulb: BA15S 12V 21W

REF 106TA4877 – Bulb: BAY15D 12V 21/5W

REF 123TA7984 – Bulb: BA15S 24V 10W

REF 103TA4603 – Bulb: BA15S 24V 21W

REF 142TA1225 – Bulb: BA15D 24V 21/5W

TOTAL SOURCE®



REAR LIGHTS

- REF 151TA5899** – 12V wire length: 770 mm
- REF 151TA5900** – 12V wire length: 1300 mm
- REF 151TA5901** – 24V wire length: 710 mm
- REF 151TA5902** – 36V wire length: 740 mm
- REF 151TA5903** – 48V wire length: 800 mm
- REF 151TA5904** – 48V wire length: 1050 mm

- Technology: incandescent
- Mounting: 2 bolts
- Center distance: 216 mm
- Functions: rear, stop, turn, reverse
- Bulbs included
- Connector: L2

- REF 106TA1277** – Bulb: BA15S 12V 10W
- REF 103TA4611** – Bulb: BA15D 12V 21W
- REF 106TA4874** – Bulb: BAY15D 12V 23/8W
- REF 123TA7984** – Bulb: BA15S 24V 10W
- REF 103TA4603** – Bulb: BA15S 24V 21W
- REF 100TA2249** – Bulb: BAY15D 24V 21/5W
- REF 100TA2197** – Bulb: BA15S 36V 10W
- REF 100TA2257** – Bulb: BAY15D 36V 25W
- REF 106TA4876** – Bulb: BAY15D 36V 25/10W
- REF 123TA7985** – Bulb: BA15S 48V 10W
- REF 106TA4865** – Bulb: BAY15D 48V 25W
- REF 106TA4877** – Bulb: BAY15D 48V 25/10W
- REF 106TA1391** – Replacement lens

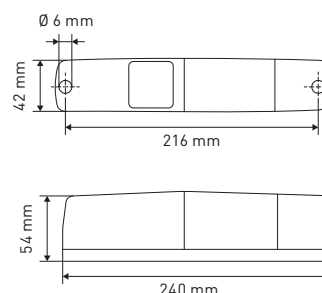

TOTAL SOURCE®



- REF 151TA3886** – 48V
- Technology: incandescent
- Mounting: 2 bolts
- Center distance: 216 mm
- Wire length: 980 mm
- Functions: rear, stop, turn, reverse
- Bulbs included
- Connector: 1 x D1, 2 x G1, 2 x H1

- REF 141TA9772** – Bulb: BA15S 48V 10W
- REF 106TA4865** – Bulb: BA15S 48V 25W
- REF 106TA4877** – Bulb: BAY15D 48V 25/10W
- REF 150TA1089** – Replacement lens white
- REF 150TA1090** – Replacement lens orange
- REF 149TA8737** – Replacement lens red
- REF 151TA3887** – Replacement guard

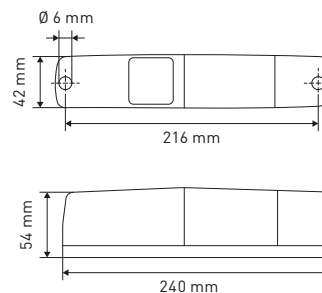

TOTAL SOURCE®



REAR LIGHTS

REF 151TA3921 – 12V

REF 151TA3922 – 24V

REF 151TA3923 – 36V

REF 151TA3924 – 48V

- Technology: incandescent
- Mounting: 2 bolts
- Center distance: 240 mm
- Functions: rear, stop, turn, reverse
- Bulbs included
- Connector: O6

REF 100TA2191 – Bulb: BA15S 12V 10W

REF 100TA2215 – Bulb: BA15S 12V 21W

REF 123TA7988 – Bulb: BAY15D 12V 21/5W

REF 106TA4860 – Bulb: BA15S 24V 10W

REF 100TA2218 – Bulb: BA15S 24V 21W

REF 123TA7989 – Bulb: BAY15D 24V 21/5W

REF 122TA9120 – Bulb: BAY15D 36V 8W

REF 100TA2257 – Bulb: BAY15D 36V 25W

REF 100TA2251 – Bulb: BAY15D 36V 25/10W

REF 141TA9772 – Bulb: BA15S 48V 10W

REF 144TA5468 – Bulb: BA15S 48V 25W

REF 106TA4877 – Bulb: BAY15D 48V 25/10W

REF 151TA3925 – Support

REF 151TA3926 – Replacement lens



TOTAL SOURCE®

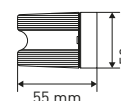
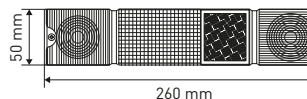

REF 151TA3914 – 12V wire length: 360 mm

REF 151TA3915 – 12V wire length: 740 mm

- Technology: incandescent
- Mounting: 2 bolts
- Center distance: 240 mm
- Functions: rear, stop, turn, reverse
- Bulbs included
- Connector: M6

REF 100TA2191 – Bulb: BA15S 12V 10W

REF 100TA2215 – Bulb: BA15S 12V 21W

REF 123TA7988 – Bulb: BA15S 12V 21W

REF 151TA3926 – Replacement lens

TOTAL SOURCE®



REAR LIGHTS

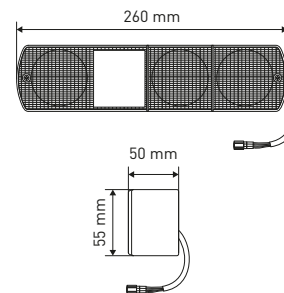

REF 151TA6066 – 12V

- Technology: incandescent
- Mounting: 2 bolts
- Wire length: 190 mm
- Functions: rear, stop, turn, reverse
- Bulbs included
- Connector: O6

REF 100TA2191 – Bulb: BA15S 12V 10W

REF 100TA2215 – Bulb: BA15S 12V 21W

REF 123TA7988 – Bulb: BA15S 12V 21W

REF 150TA3536 – Replacement lens

TOTAL SOURCE®

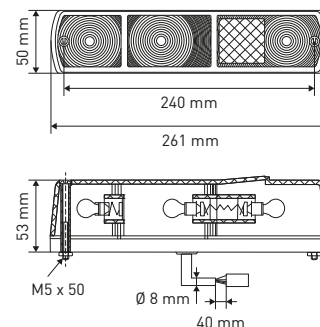

REF 151TA3888 – 12V

REF 151TA3889 – 24V

REF 151TA3890 – 48V

- Technology: incandescent
- Mounting: 2 bolts
- Center distance: 240 mm
- Wire length: 490 mm
- Functions: rear, stop, turn, reverse
- Bulbs included
- Used for Mitsubishi
- Connector: O6

REF 100TA2191 – Bulb: BA15S 12V 10W

REF 103TA4602 – Bulb: BA15S 12V 25W

REF 106TA4904 – Bulb: BAY15D 12V 23/8W

REF 123TA7984 – Bulb: BA15S 24V 10W

REF 103TA4604 – Bulb: BA15S 24V 25W

REF 100TA2250 – Bulb: BAY15D 24V 25/10W

REF 161TA6024 – Bulb: BA15S 48V 10W

REF 144TA5468 – Bulb: BA15S 48V 25W

REF 106TA4877 – Bulb: BAY15D 48V 25/10W

REF 151TA3891 – Replacement lens

REF 151TA3891 – Replacement lens kit

TOTAL SOURCE®



REAR LIGHTS

REF [151TA3907](#) – 48V

- Technology: incandescent
- Mounting: 2 bolts
- Center distance: 240 mm
- Wire length: 145 mm
- Functions: rear, stop, turn, reverse
- Bulbs included
- Used for TCM
- Connector: O6

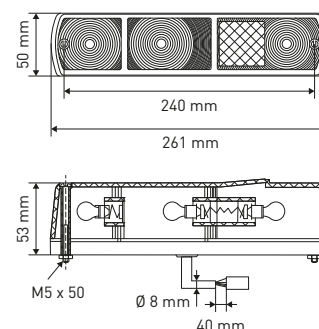

REF [161TA6024](#) – Bulb: BA15S 48V 10W

REF [144TA5468](#) – Bulb: BA15S 48V 25W

REF [144TA5615](#) – Bulb: BAY15D 48V 25/10W

REF [151TA3891](#) – Replacement lens

TOTAL SOURCE®

REF [151TA6041](#) – 12V

- Technology: incandescent
- Mounting: 2 bolts
- Center distance: 240 mm
- Wire length: 200 mm
- Functions: rear, stop, turn, reverse
- Bulbs included
- Connector: A5

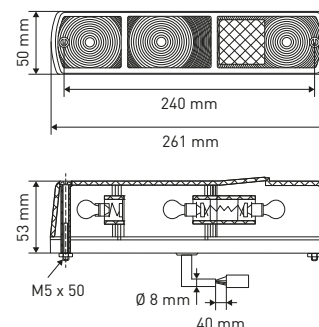

REF [100TA2191](#) – Bulb: BA15S 12V 10W

REF [101TA9495](#) – Bulb: BA15S 12V 25W

REF [106TA4904](#) – Bulb: BAY15D 12V 23/8W

REF [151TA3904](#) – Replacement lens

TOTAL SOURCE®

REF [151TA3903](#) – 12V

- Technology: incandescent
- Mounting: 2 bolts
- Center distance: 240 mm
- Wire length: 145 mm
- Functions: rear, stop, turn, reverse
- Bulbs included

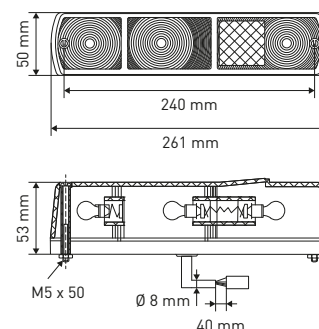

REF [100TA2191](#) – Bulb: BA15S 12V 10W

REF [101TA9495](#) – Bulb: BA15S 12V 25W

REF [106TA4904](#) – Bulb: BAY15D 12V 23/8W

REF [151TA3904](#) – Replacement lens

TOTAL SOURCE®



REAR LIGHTS

REF 151TA6046 – 12V

REF 151TA6047 – 24V

- Technology: incandescent
- Mounting: 2 bolts
- Center distance: 230 mm
- Wire length: 235 mm
- Functions: rear, stop, turn, reverse
- Bulbs included
- Connector: M6

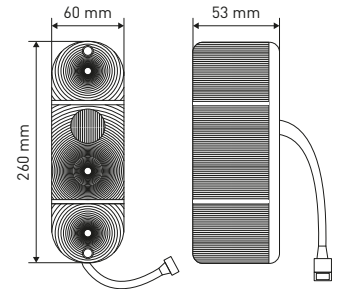

REF 100TA2191 – Bulb: BA15S 12V 10W

REF 100TA2216 – Bulb: BA15S 12V 23W

REF 106TA4904 – Bulb: BAY15D 12V 23/8W

REF 106TA4854 – Bulb: BA15S 24V 10W

REF 100TA2219 – Bulb: BA15S 24V 25W

REF 144TA5502 – Bulb: BAY15D 24V 25/10W

REF 150TA4601 – Replacement lens

TOTAL SOURCE®

REF 151TA3911 – 12V

REF 151TA3912 – 24V

REF 151TA3913 – 48V

- Technology: incandescent
- Mounting: 2 bolts
- Center distance: 250 mm
- Functions: rear, stop, turn, reverse
- Bulbs included
- Connector: B5, K1 built-in

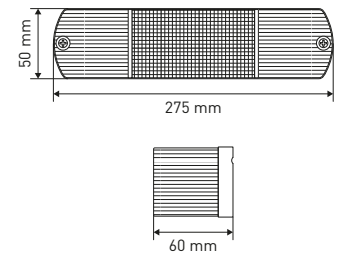

REF 100TA2215 – Bulb: BA15S 12V 21W

REF 123TA7988 – Bulb: BAY15D 12V 21/5W

REF 100TA2218 – Bulb: BA15S 24V 21W

REF 123TA7989 – Bulb: BAY15D 24V 21/5W

REF 123TA7987 – Bulb: BA15S 48V 25W

REF 123TA7990 – Bulb: BAY15D 48V 25/10W

REF 150TA1302 – Replacement lens red

REF 150TA1305 – Replacement lens white

REF 150TA1304 – Replacement lens orange

TOTAL SOURCE®

REF 151TA6101 – Without bulbs

REF 151TA6100 – 12V

REF 151TA6099 – 48V

- Technology: incandescent
- Mounting: 2 bolts
- Center distance: 253 mm
- Functions: rear, stop, turn, reverse
- Bulbs included
- Connector: B5, K1 built-in

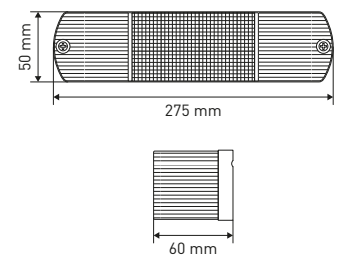
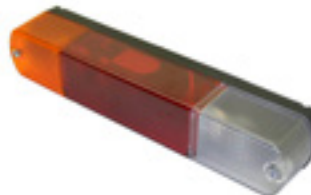

REF 100TA2246 – Bulb: BAY15D 12V 21/5W

REF 100TA2215 – Bulb: BA15S 12V 21W

REF 144TA5468 – Bulb: BA15S 48V 25W

REF 144TA5615 – Bulb: BAY15D 48V 25/10W

REF 150TA2100 – Replacement lens kit

TOTAL SOURCE®



REAR LIGHTS

- REF 151TA6011** – LH
REF 151TA6009 – RH
- Technology: incandescent
 - Mounting: 2 bolts
 - Center distance: 45 mm
 - 12–24V
 - Functions: rear, stop, turn
 - Bulbs not included



LH

RH

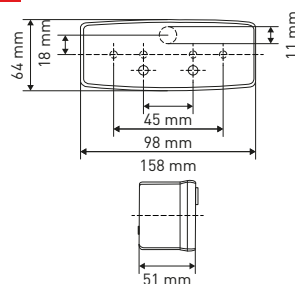

E-approved

- REF 103TA4596** – Bulb: BA15S 12V 10W
REF 122TA9113 – Bulb: BA15S 12V 21W
REF 106TA4860 – Bulb: BA15S 24V 10W
REF 103TA4603 – Bulb: BA15S 24V 21W
REF 151TA6109 – Replacement lens LH
REF 151TA6110 – Replacement lens RH

- REF 151TA6020** – 12V
REF 151TA6021 – 24V with AMP-connector
- Technology: incandescent
 - Mounting: 2 bolts
 - Center distance: 57 mm
 - Functions: rear, stop, reverse
 - Bulbs included

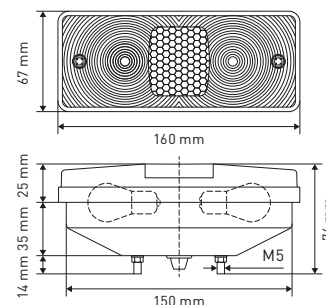

E-approved

- REF 123TA7988** – Bulb: BAY15D 12V 21/5W
REF 122TA9113 – Bulb: BA15S 12V 21W
REF 100TA2249 – Bulb: BAY15D 24V 21/5W
REF 103TA4603 – Bulb: BA15S 24V 21W
REF 150TA2229 – Replacement lens

- REF 151TA5938** – 12V
REF 151TA5939 – Without bulbs
- Technology: incandescent
 - Mounting: 2 bolts
 - Center distance: 57 mm
 - Functions: rear, stop, turn

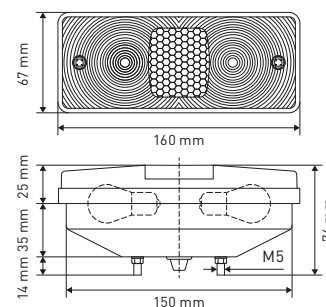

E-approved

- REF 103TA4621** – Bulb: BAY15D 12V 21/5W
REF 100TA2215 – Bulb: BA15S 12V 21W



REAR LIGHTS

- REF 151TA6005** – LH
REF 151TA6006 – RH
- Technology: incandescent
 - Mounting: 2 bolts
 - Center distance: 70 mm
 - 12–24V
 - Functions: rear, stop, turn
 - Bulbs not included



LH



RH

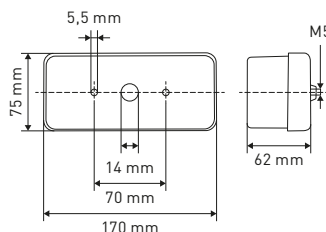

- REF 103TA4596** – Bulb: BA15S 12V 10W
REF 122TA9113 – Bulb: BA15S 12V 21W
REF 106TA4860 – Bulb: BA15S 24V 10W
REF 103TA4603 – Bulb: BA15S 24V 21W
REF 151TA6007 – Replacement lens LH
REF 151TA6008 – Replacement lens RH



E-approved

- REF 151TA6032** – 24V
- Technology: incandescent
 - Mounting: 2 bolts
 - Center distance: 134 mm
 - Wire length: 150 mm
 - Functions: rear, stop, reverse
 - Bulbs included
 - Connector: K4

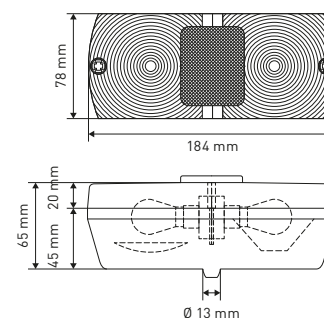

- REF 103TA4603** – Bulb: BA15S 24V 21W
REF 100TA2249 – Bulb: BAY15D 24V 21/5W
REF 150TA2230 – Replacement lens



E-approved

- REF 151TA6012**
- Technology: incandescent
 - Mounting: 2 bolts
 - Center distance: 134 mm
 - 12V
 - Functions: rear, stop, reverse
 - Bulbs not included

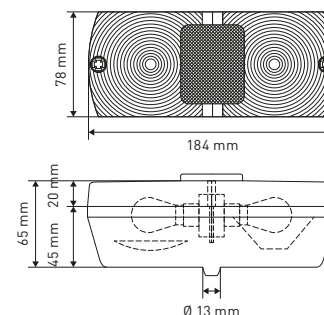

- REF 100TA2215** – Bulb: BA15S 12V 21W
REF 100TA2246 – Bulb: BAY15D 12V 21/5W
REF 103TA4603 – Bulb: BA15S 24V 21W
REF 100TA2249 – Bulb: BAY15D 24V 21/5W
REF 151TA6014 – Replacement lens
REF 151TA6013 – Bracket



E-approved



REAR LIGHTS

- REF 151TA6022** – 12V with wire length: 200 mm
REF 151TA6023 – 12V with wire length: 640 mm
- Technology: incandescent
 - Mounting: 2 bolts
 - Center distance: 134 mm
 - Functions: rear, stop, turn
 - Bulbs included
 - Connector: H4

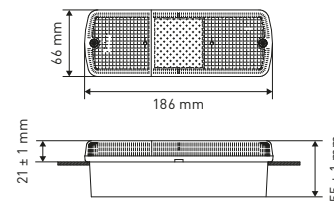

- REF 100TA2246** – Bulb: BAY15D 12V 21/5W
REF 100TA2215 – Bulb: BA15S 12V 21W
REF 127TA2919 – Replacement lens

E-approved

TOTAL SOURCE®

- REF 151TA5976** – 12V LH with fog
REF 151TA5975 – 12V LH with reverse
REF 151TA5977 – 12V RH

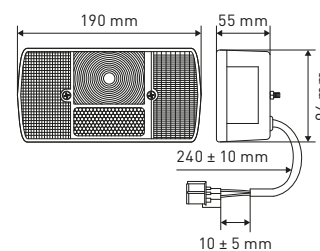

- REF 100TA2215** – Bulb: BA15S 12V 21W
REF 100TA2246 – Bulb: BAY15D 12V 21/5W
REF 150TA4542 – Replacement lens LH
REF 150TA4543 – Replacement lens RH

E-approved

TOTAL SOURCE®

- REF 151TA6080** – LH
REF 151TA6079 – RH
- Technology: incandescent
 - Mounting: 2 bolts
 - Center distance: 55 mm
 - 12–24V
 - Functions: rear, stop, turn, reverse, license
 - Bulbs not included

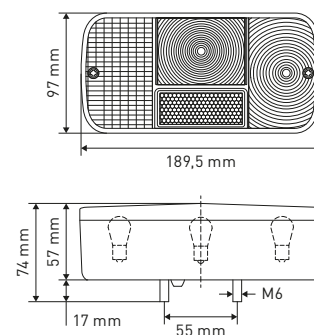

- REF 100TA2246** – Bulb: BAY15D 12V 21/5 W
REF 100TA2215 – Bulb: BA15S 12V 21W
REF 103TA4603 – Bulb: BA15S 24V 21W
REF 100TA2249 – Bulb: BAY15D 24V 21/5W
REF 150TA4542 – Replacement lens LH
REF 150TA4706 – Replacement lens RH

E-approved

COBO®
group



REAR LIGHTS

REF 151TA6087 – LH

REF 151TA6088 – RH

- Technology: incandescent
- Mounting: 2 bolts
- Center distance: 55 mm
- Wire length: 315 mm
- 12-24V
- Functions: rear, stop, turn, reverse
- Bulbs not included
- Connector: P6

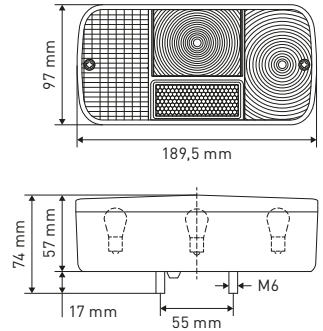

REF 100TA2246 – Bulb: BAY15D 12V 21/5 W

REF 100TA2215 – Bulb: BA15S 12V 21W

REF 103TA4603 – Bulb: BA15S 24V 21W

REF 100TA2249 – Bulb: BAY15D 24V 21/5W

REF 150TA4542 – Replacement lens LH

REF 150TA4706 – Replacement lens RH



E-approved

REF 151TA6024 – 12V

- Technology: incandescent
- Mounting: 2 bolts
- Center distance: 154 mm
- Functions: rear, stop, turn
- Bulbs included

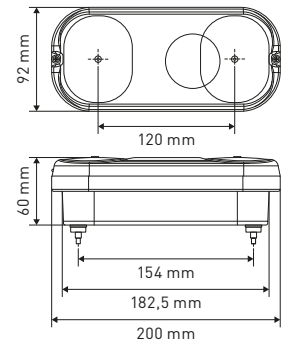

REF 100TA2246 – Bulb: BAY15D 12V 21/5 W

REF 100TA2215 – Bulb: BA15S 12V 21W

REF 151TA6025 – Replacement lens



E-approved

REF 151TA5945 – 12V

- Technology: incandescent
- Mounting: 2 bolts
- Center distance: 177 mm
- Wire length: 160 mm
- Functions: rear, stop, turn, reverse
- Bulbs included
- Connector: H6

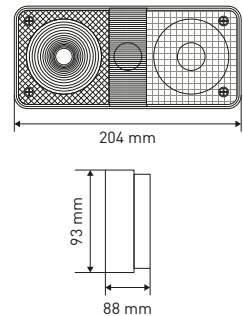

REF 106TA1277 – Bulb: BA15S 12V 10W

REF 123TA7988 – Bulb: BAY15D 12V 21/5 W





REAR LIGHTS

REF 151TA6089 – 12V LH

REF 151TA6090 – 12V RH with back-up light

- Technology: incandescent
- Mounting: 2 bolts
- Center distance: 152 mm
- Functions: rear, stop, turn, reverse
- Bulbs included
- Connector: J6

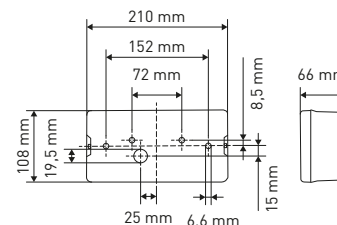

REF 103TA4596 – Bulb: BA15S 12V 10W

REF 100TA2215 – Bulb: BA15S 12V 21W

E-approved



REF 151TA6082 – LH

- Technology: incandescent
- Mounting: 2 bolts
- Center distance: 152 mm
- 12–24V
- Functions: rear, stop, turn, reverse
- Bulbs not included

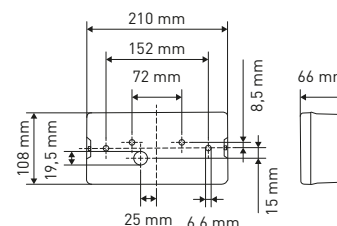

REF 103TA4596 – Bulb: BA15S 12V 10W

REF 100TA2215 – Bulb: BA15S 12V 21W

REF 106TA4860 – Bulb: BA15S 24V 10W

REF 103TA4603 – Bulb: BA15S 24V 21W

E-approved



REF 151TA6062 – LH

REF 151TA6063 – RH

- Technology: incandescent
- Mounting: 2 bolts
- Center distance: 152 mm
- 12–24V
- Functions: rear, stop, turn, fog
- Bulbs not included

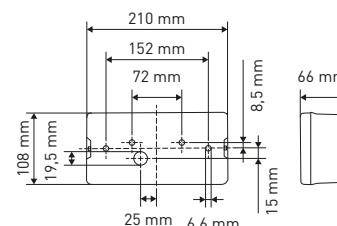

REF 103TA4596 – Bulb: BA15S 12V 10W

REF 100TA2215 – Bulb: BA15S 12V 21W

REF 106TA4860 – Bulb: BA15S 24V 10W

REF 103TA4603 – Bulb: BA15S 24V 21W

REF 151TA6083 – Replacement lens LH

REF 151TA6065 – Replacement lens RH

E-approved





REAR LIGHTS

- REF 151TA6086** – 24V without wire
REF 151TA6085 – 24V wire length: 910 mm
- Technology: incandescent
 - Mounting: 2 bolts
 - Center distance: 155 mm
 - Functions: rear, stop, turn, reverse,
 - Bulbs included
 - Used for Hyster and Yale
 - Connector: D6

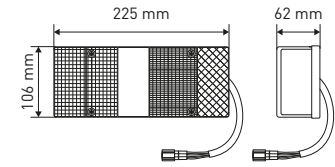

- REF 100TA2209** – Bulb: BA15S 24V 5W
REF 100TA2218 – Bulb: BA15S 24V 21W (3x)

E-approved

TOTAL SOURCE®

- REF 151TA6103** – 12V LH
REF 151TA6102 – 12V RH
- Technology: incandescent
 - Mounting: 2 bolts
 - Center distance: 49 mm
 - Functions LH: rear, stop, turn, fog
 - Functions RH: rear, stop, turn, reverse
 - Bulbs included
 - Connector: D6 built-in

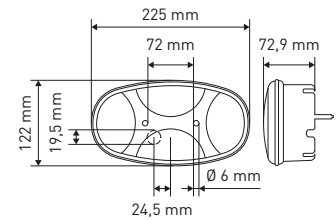

- REF 103TA4596** – Bulb: BA15S 12V 10W
REF 100TA2215 – Bulb: BA15S 12V 21W
REF 151TA6105 – Replacement lens LH
REF 151TA6104 – Replacement lens RH

E-approved



- REF 151TA6034** – 12V LH
REF 151TA6035 – 12V RH + reverse
- Technology: incandescent
 - Mounting: 2 bolts
 - Center distance: 152 mm
 - Functions: rear, stop, turn, fog, license
 - Bulbs included
 - Connector: C6 built-in

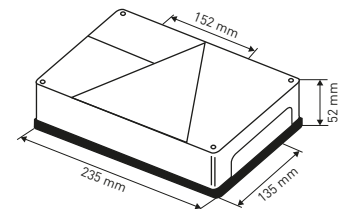

- REF 100TA2246** – Bulb: BAY15D 12V 21/5W
REF 100TA2215 – Bulb: BA15S 12V 21W
REF 100TA2218 – Bulb: BA15S 24V 21W (3x)
REF 150TA4720 – Replacement lens RH

E-approved

TOTAL SOURCE®



REAR LIGHTS

REF 151TA6093 – 12V LH

REF 151TA6094 – 12V RH

- Technology: incandescent
- Mounting: 2 bolts
- Center distance: 152 mm
- Functions: rear, stop, turn, reverse, fog, license, reflector triangle
- Bulbs included
- Connector: A8

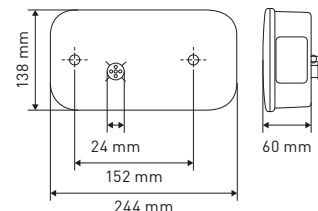

REF 100TA2118 – Bulb: SV 8,5-8 12V 5W

REF 100TA2215 – Bulb: BA15S 12V 21W

REF 123TA7988 – Bulb: BAY15D 12V 21/5W

E-approved

TOTAL SOURCE[®]

REF 151TA6084 – 12V

- Technology: incandescent
- Mounting: 2 bolts
- Center distance: 152 mm
- Functions: rear, stop, turn, reverse, fog
- Bulbs included
- Connector: E6 & E2

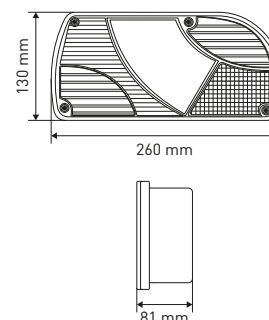

REF 115TA4602 – Bulb: BA15S 12V 5W

REF 140TA8980 – Bulb: BAU15S 12V 21W orange

REF 100TA2215 – Bulb: BA15S 12V 21W

REF 150TA6357 – Replacement lens

E-approved

COBO[®]
group

REF 151TA6091 – 12V LH

REF 151TA6094 – 12V RH

- Technology: incandescent
- Mounting: 4 bolts
- Center distance: 190 mm
- Functions: rear, stop, turn, fog
- Bulbs included
- Connector: Q6

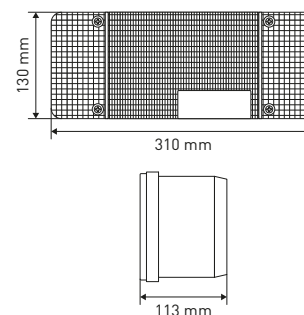

REF 161TA6075 – Bulb: BA15S 12V 5W

REF 100TA2215 – Bulb: BA15S 12V 21W

REF 150TA4540 – Replacement lens

E-approved

COBO[®]
group



REAR LIGHTS

REF 151TA6049 – LH

REF 151TA6048 – RH

- Technology: incandescent
- Mounting: 2 bolts
- Center distance: 152 mm
- 12–24V
- Functions: rear, stop, turn, reverse, fog
- Bulbs not included

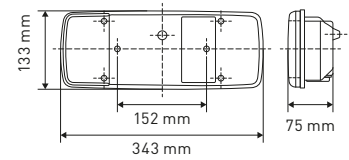

REF 103TA4596 – Bulb: BA15S 12V 10W

REF 100TA2215 – Bulb: BA15S 12V 21W

REF 100TA2195 – Bulb: BA15S 24V 10W

REF 100TA2218 – Bulb: BA15S 24V 21W

REF 150TA5799 – Replacement lens



E-approved

REF 151TA6018

- Technology: incandescent
- Mounting: 2 bolts
- Center distance: 152 mm
- 12–24V
- Functions: rear, stop, turn, reverse, fog
- Bulbs not included

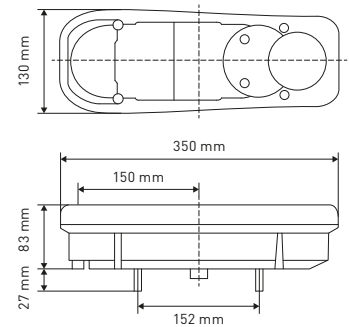

REF 103TA4596 – Bulb: BA15S 12V 10W

REF 100TA2215 – Bulb: BA15S 12V 21W

REF 106TA4860 – Bulb: BA15S 24V 10W

REF 103TA4603 – Bulb: BA15S 24V 21W

REF 151TA6019 – Replacement lens

E-approved

TOTAL SOURCE®

REF 151TA6042 – 12V

- Technology: incandescent
- Mounting: internal
- Functions: rear, stop, reverse
- Bulbs included

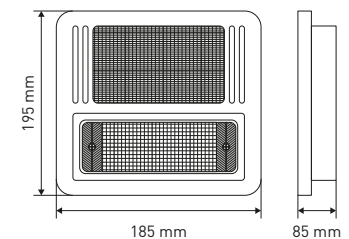

REF 142TA1296 – Bulb: W2.1x9.5D 12V 10W

REF 100TA2215 – Bulb: BA15S 12V 21W

REF 151TA6043 – Replacement lens red

TOTAL SOURCE®



REAR LIGHTS

REF 151TA6004 – 24V

- Technology: LED
- Mounting: 2 bolts
- Center distance: 80 mm
- Wire length: 260 mm
- Function: rear
- Connector: G2

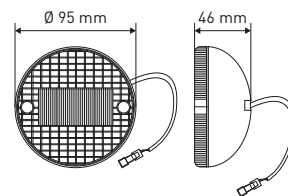

E-approved

TOTAL SOURCE[®]
BRAND: JOKON

REF 151TA5960 – 12V without connector

REF 151TA5959 – 12V with connector K4

- Technology: LED
- Mounting: 2 bolts
- Center distance: 45 mm
- Wire length: 230 mm
- Functions: rear, turn, stop

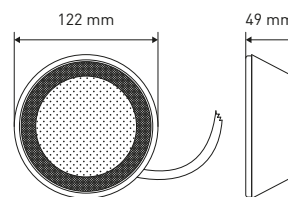

E-approved

TOTAL SOURCE[®]

REF 163TA8807 – 10-24V

- Technology: LED
- Mounting: 2 bolts
- Center distance: 45 mm
- Functions: rear, stop, turn

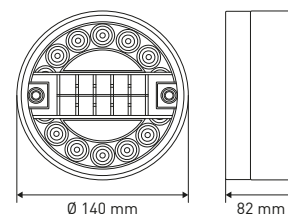

E-approved

TOTAL SOURCE[®]



REAR LIGHTS

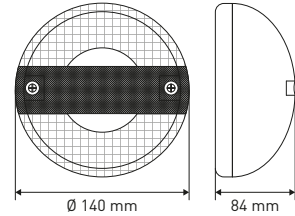

- REF 151TA5962** – 24V without connector
- REF 151TA5961** – 24V with Deutsch connector A4
- REF 151TA5963** – 12–24V without connector
- Technology: LED
- Mounting: 2 bolts
- Center distance: 45 mm
- Wire length: 280 mm
- Functions: rear, stop, turn

E-approved

TOTAL SOURCE®

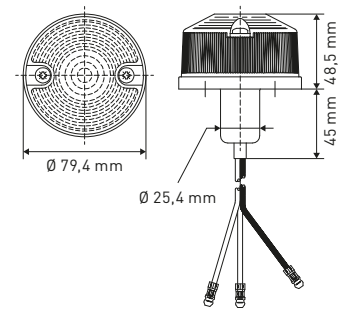

- REF 151TA5984** – 12V
- Technology: incandescent
- Mounting: internal
- Wire length: 250 mm
- Functions: rear, stop
- Bulb not included

- REF 100TA2246** – Bulb: BAY15D 12V 21/5W
- REF 150TA5235** – Replacement lens

E-approved

TOTAL SOURCE®

BRAND: BRITAX

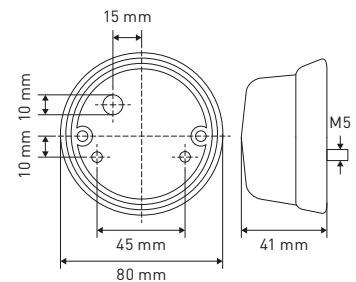

- REF 151TA5982**
- Technology: incandescent
- Mounting: 2 bolts
- Center distance: 45 mm
- 12–24V
- Functions: rear
- Bulb not included

Amber version, see page 43 (REF 151TA3944)
Green version, see page 155 (REF 151TA3265)

- REF 100TA2126** – Bulb: SV8,5-8 12V 18W
- REF 106TA4833** – Bulb: SV8,5-8 24V 18W

E-approved





REAR LIGHTS

REF 151TA5950

- Technology: incandescent
- Mounting: 2 bolts
- Center distance: 45 mm
- 12V
- Functions: rear, stop, turn
- Bulbs not included

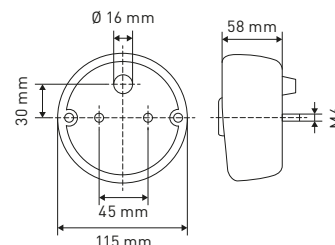

REF 106TA4831 – Bulb: SV 8,5-8 12V 10W

REF 151TA3266 – Bulb: SV 8,5-8 12V 18W

REF 151TA5949 – Replacement lens



E-approved

REF 151TA5948 – 12V

REF 151TA5947 – 24V

- Technology: incandescent
- Mounting: 2 bolts
- Center distance: 45 mm
- Wire length: 490 mm
- Functions: rear, stop, turn
- Bulbs included

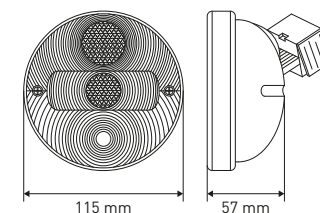

REF 106TA4831 – Bulb: SV 8,5-8 12V 10W

REF 106TA4896 – Bulb: S8,5 12V 21W

REF 106TA4907 – Bulb: SV8,5-8 24V 10W

REF 106TA4833 – Bulb: SV8,5-8 24V 18W

REF 151TA5949 – Replacement lens



REF 151TA5979

REF 151TA5980 – 24V with bulbs wire length: 390 mm

REF 151TA5981 – 12V bulb included

- Technology: incandescent
- Mounting: 2 bolts
- Center distance: 45 mm
- Functions: rear, stop, turn, reverse
- No bulbs included

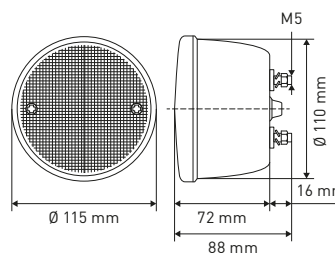

REF 100TA2215 – Bulb: BA15S 12V 21W

REF 103TA4621 – Bulb: BAY15D 12V 21/5W

REF 103TA4603 – Bulb: BA15S 24V 21W

REF 106TA4875 – Bulb: BAY15D 24V 21/5W

REF 150TA4704 – Replacement lens



E-approved



REAR LIGHTS

- REF 151TA6061** – 12V without cable
- REF 151TA6060** – 12V wire length: 390 mm
- REF 151TA5946** – 24V wire length: 210 mm
- Technology: incandescent
- Mounting: 2 bolts
- Center distance: 45 mm
- Functions: rear, stop, turn
- Bulbs included

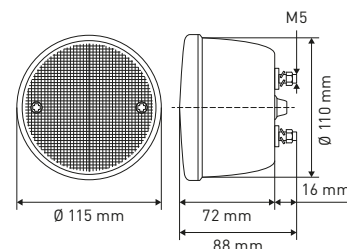

- REF 106TA4831** – Bulb: SV 8,5-8 12V 10W
- REF 100TA2215** – Bulb: BA15S 12V 21W
- REF 106TA4907** – Bulb: SV8,5-8 24V 10W
- REF 103TA4603** – Bulb: BA15S 24V 21W
- REF 150TA3405** – Replacement lens



E-approved

- REF 151TA5954**
- Technology: incandescent
- Mounting: 2 bolts
- Center distance: 45 mm
- 12–24V
- Functions: rear, stop, turn
- Bulbs not included

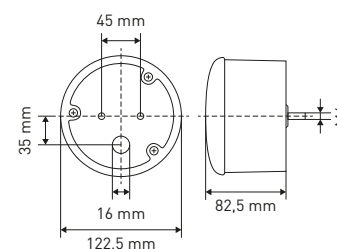

- REF 100TA2215** – Bulb: BA15S 12V 21W
- REF 123TA7988** – Bulb: BAY15D 12V 21/5 W
- REF 103TA4603** – Bulb: BA15S 24V 21W
- REF 123TA7989** – Bulb: BAY15D 24V 21/5W
- REF 151TA5955** – Replacement lens



E-approved

- REF 151TA5952** – Without license function
- REF 151TA5953** – Including license function
- Technology: incandescent
- Mounting: 2 bolts
- Center distance: 45 mm
- 12–24V
- Functions: rear, stop, turn
- Bulbs not included

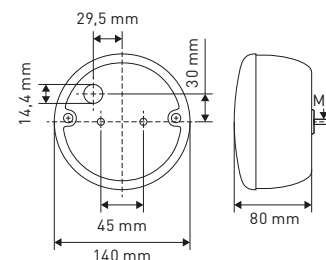

- REF 115TA4602** – Bulb: BA15S 12V 5W
- REF 100TA2215** – Bulb: BA15S 12V 21W
- REF 103TA4597** – Bulb: BA15S 24V 5W
- REF 115TA4603** – Bulb: BA15S 24V 21W
- REF 144TA1688** – Replacement lens



E-approved



REAR LIGHTS

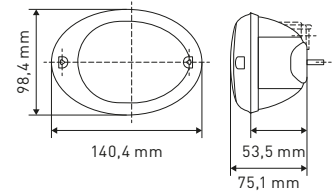

REF 151TA6078 – 12V

- Technology: incandescent
- Mounting: 2 bolts
- Center distance: 45 mm
- Functions: rear, stop, turn
- Bulbs included

REF 100TA2215 – Bulb: BA15S 12V 21W

E-approved

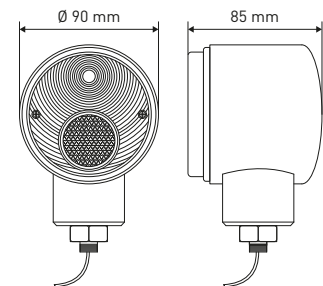

REF 151TA5951 – 24V

- Technology: incandescent
- Mounting: single bolt
- Wire length: 90 mm
- Functions: rear, stop
- Bulbs included
- Used for Nissan

REF 100TA2249 – Bulb: BAY15D 24V 21/5W

REF 151TA3951 – Replacement lens back

REF 150TA1099 – Replacement lens front

TOTAL SOURCE®



BUILT-IN

REF 151TA6037 – LH

REF 151TA6038 – RH

- Technology: incandescent
- Mounting: internal
- 24V
- Functions: rear, stop, turn, reverse
- Bulbs not included

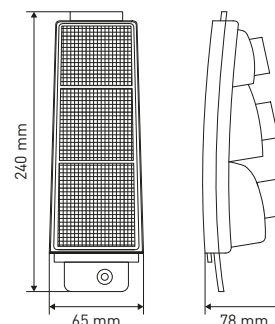

REF 144TA5560 – Bulb: BAU15S 24V 21W orange

REF 123TA7989 – Bulb: BAY15D 24V 21/5W



E-approved

REF 151TA6074 – 12V

- Technology: incandescent
- Mounting: internal
- Wire length: 500 mm
- Functions: rear, stop, turn, reverse
- Bulbs included
- Connector: O6

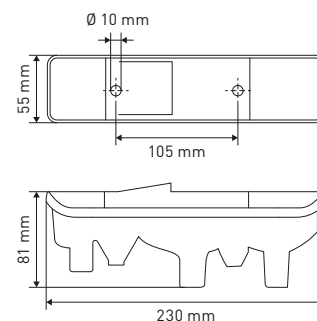

REF 151TA5944 – Bulb: BA15S 12V 10W

REF 100TA2215 – Bulb: BA15S 12V 21W

REF 123TA7988 – Bulb: BAY15D 12V 21/5W

REF 151TA6075 – Replacement lens orange

REF 151TA6076 – Replacement lens red

REF 151TA6077 – Replacement lens white

TOTAL SOURCE®

REF 151TA6067 – 12V

REF 151TA6068 – 48V

- Technology: incandescent
- Mounting: internal
- Functions: rear, stop, turn, reverse
- Bulbs included
- Connector: I3+J2

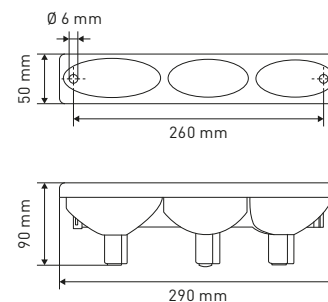

REF 103TA4586 – Bulb: BA15S 12V 10W

REF 103TA4602 – Bulb: BA15S 12V 25W

REF 103TA4621 – Bulb: BAY15D 12V 21/5W

REF 161TA6024 – Bulb: BA15S 48V 10W

REF 144TA5468 – Bulb: BA15S 48V 25W

REF 106TA4877 – Bulb: BAY15D 48V 25/10W

REF 151TA6069 – Replacement lens

TOTAL SOURCE®



BUILT-IN

- REF 151TA5940** – 12V LH
REF 151TA5941 – 12V RH
- Technology: incandescent
 - Mounting: internal 4 bolts
 - Center distance: 98 mm
 - Wire length: 345 mm
 - Functions: rear, stop, turn
 - Bulbs included
 - Connector: M4

- REF 151TA5944** – Bulb: BA15S 12V 10W
REF 100TA2246 – Bulb: BAY15D 12V 21/5 W
REF 151TA5942 – Replacement lens

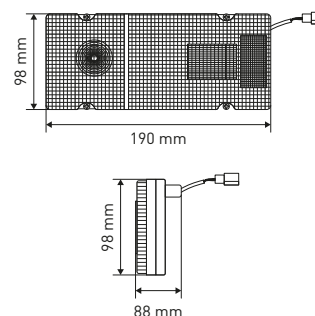

TOTAL SOURCE[®]

- REF 151TA6017** – 12V LH
REF 151TA6016 – 12V RH
- Technology: incandescent
 - Mounting: internal
 - Wire length: 310 mm
 - Functions: rear, stop, turn
 - Connector: I4

- REF 106TA1277** – Bulb: BA15S 12V 10W
REF 123TA7988 – Bulb: BAY15D 12V 21/5W
REF 150TA5353 – Replacement lens

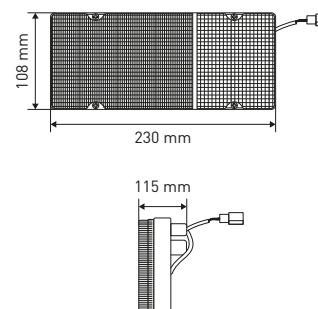

TOTAL SOURCE[®]

- REF 151TA5936** – 24V LH
REF 151TA5937 – 24V RH
- Technology: incandescent
 - Mounting: internal
 - Wire length: 800 mm
 - Functions: rear, stop, turn, reverse
 - Bulbs included
 - Connector: H6

- REF 103TA4603** – Bulb: BA15S 24V 21W
REF 123TA7989 – Bulb: BAY15D 24V 21/5W
REF 150TA2553 – Replacement lens LH
REF 150TA2552 – Replacement lens RH

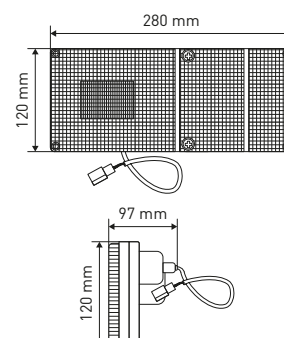

TOTAL SOURCE[®]

E-approved



BUILT-IN

REF 151TA6108 – 24V LH

REF 151TA6107 – 24V RH

- Technology: incandescent
- Mounting: internal
- Functions: rear, stop, turn, reverse
- Bulbs included

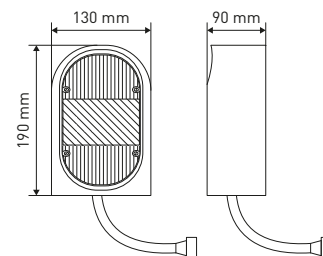

REF 100TA2249 – Bulb: BAY15D 24V 21/5W

REF 100TA2218 – Bulb: BA15S 24V 21W

REF 140TA8979 – Bulb: BAU15S 24V 21W orange

REF 150TA3112 – Replacement lens

E-approved

TOTAL SOURCE®

REF 151TA6072 – 12V LH

REF 151TA6073 – 12V RH

- Technology: incandescent
- Mounting: internal
- Functions: rear, stop, turn
- Bulbs included

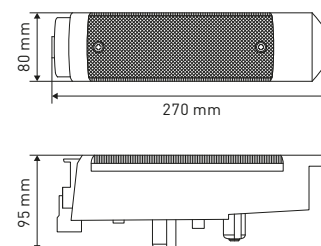

REF 100TA2246 – Bulb: BAY15D 12V 21/5W

REF 100TA2215 – Bulb: BA15S 12V 21W

REF 150TA3718 – Replacement lens kit LH

REF 150TA9423 – Replacement lens kit RH

TOTAL SOURCE®

REF 151TA5934 – 12V LH

REF 151TA5935 – 12V RH

REF 151TA5932 – 48V LH

REF 151TA5933 – 48V RH

- Technology: incandescent
- Mounting: internal
- Wire length: 210 mm
- Functions LH: rear, stop, turn
- Functions RH: rear, stop, turn, reverse
- Bulbs included
- Used for Toyota 7-series (light grey housing)

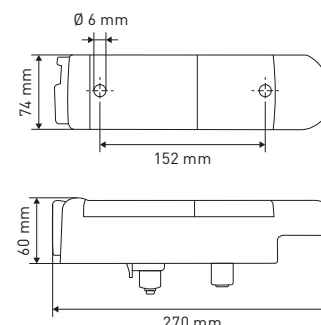

REF 106TA1277 – Bulb: BA15S 12V 10W

REF 100TA2246 – Bulb: BAY15D 12V 21/5W

REF 144TA5468 – Bulb: BA15S 48V 25W

REF 123TA7990 – Bulb: BAY15D 48V 25/10W

REF 151TA5929 – Replacement lens amber

REF 151TA5930 – Replacement lens red

REF 151TA5931 – Replacement lens white

TOTAL SOURCE®



BUILT-IN

- REF [151TA5927](#) – 12V LH
- REF [151TA5928](#) – 12V RH
- REF [151TA5925](#) – 48V LH
- REF [151TA5926](#) – 48V RH
- Technology: incandescent
- Mounting: internal
- Functions LH: rear, stop, turn
- Functions RH: rear, stop, turn, reverse
- Bulbs included
- Used for Toyota 7-series (dark grey housing)

- REF [106TA1277](#) – Bulb: BA15S 12V 10W
- REF [100TA2246](#) – Bulb: BAY15D 12V 21/5W
- REF [144TA5468](#) – Bulb: BA15S 48V 25W
- REF [123TA7990](#) – Bulb: BAY15D 48V 25/10W
- REF [151TA5929](#) – Replacement lens amber
- REF [151TA5930](#) – Replacement lens red
- REF [151TA5931](#) – Replacement lens white



LH



RH

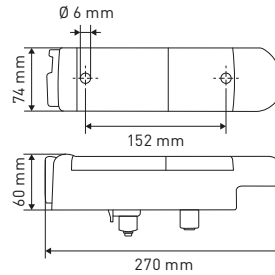

TOTAL SOURCE®

- REF [151TA6044](#) – 12V
- REF [151TA6045](#) – 12V with fog lamp
- Technology: incandescent
- Mounting: 2 bolts
- Center distance: 222 mm
- Functions: rear, stop, turn, reverse
- Bulbs included
- Connector: C6

- REF [100TA2215](#) – Bulb: BA15S 12V 21W
- REF [123TA7988](#) – Bulb: BAY15D 12V 21/5 W
- REF [141TA1566](#) – Replacement lens white
- REF [150TA6250](#) – Replacement lens red
- REF [161TA6000](#) – Replacement lens orange

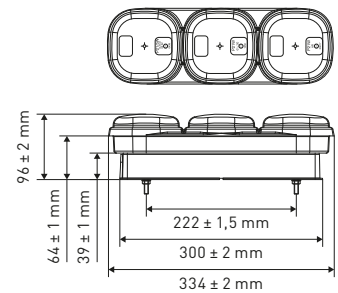

E-approved

TOTAL SOURCE®



REAR RAMP

REF 150TA9504 – 12V

- Technology: LED
- Mounting: 2 bolts
- Center distance 790 mm
- Wire length: 4000 mm with male plug with 7 plastic road studs
- Functions: rear, stop, turn, license, reflector and triangle reflector
- Certified CE E11



E-approved

TOTAL SOURCE[®]



REFLECTORS



NICE TO KNOW – REFLECTORS

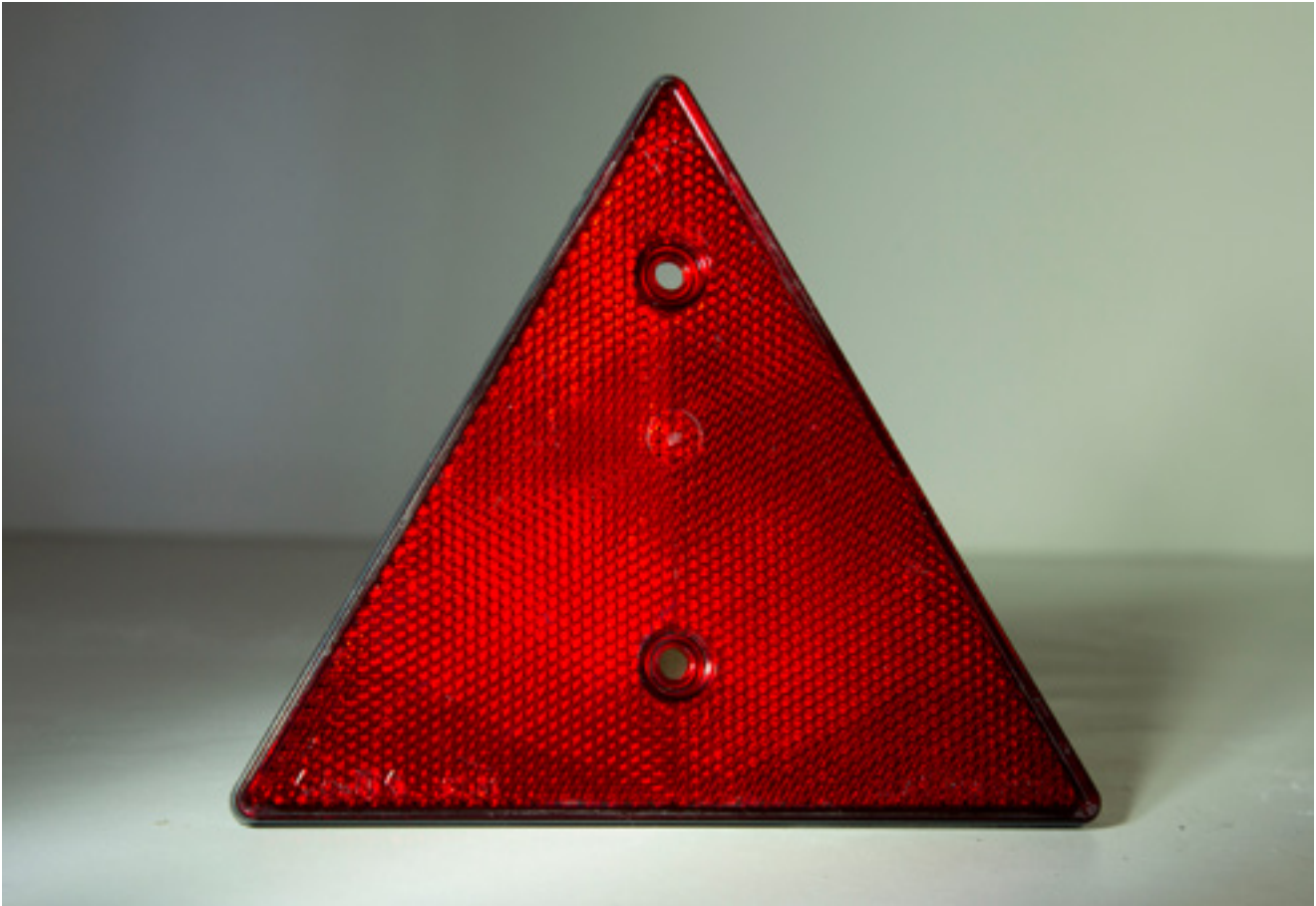

A reflector reflects the incoming light in the same direction. This way, lights of surrounding vehicles can make even a stationary vehicle visible in the dark.

Reflectors exist in a number of different colours and shapes. The installation is done by means of stickers or bolts, depending on the model.

In certain countries it is mandatory to attach a reflective triangle to the back of the vehicle in case of use on public roads. Depending on the country, this reflector must be part of the rear light or it can be attached to the back of the vehicle as a separate reflector. The road regulations of the country in question must be observed in this case.



REFLECTORS

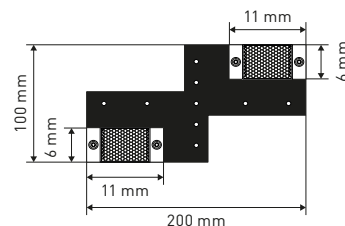

REF 150TA7927

- Colour: white
- Shape: mainly rectangular/square
- Mounting: screws
- Center distance: 180 mm
- Spare reflectors (REF 150TA7930)

TOTAL SOURCE[®]

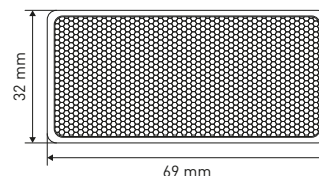
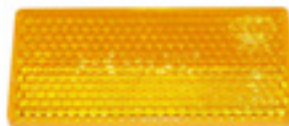

REF 150TA7838

- Colour: orange
- Shape: rectangular
- Mounting: adhesive



E-approved

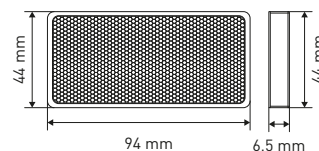

REF 150TA7837

- Colour: orange
- Shape: rectangular
- Mounting: adhesive

TOTAL SOURCE[®]

E-approved

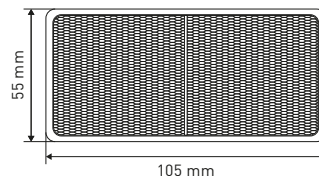

REF 150TA8456

- Colour: orange
- Shape: rectangular
- Mounting: adhesive

TOTAL SOURCE[®]

E-approved



REFLECTORS

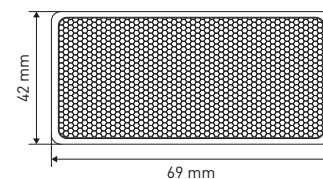

REF 150TA7518

- Colour: red
- Shape: rectangular
- Mounting: adhesive



E-approved

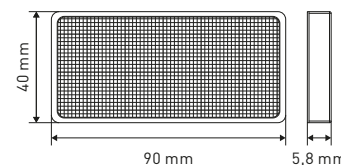

REF 152TA1646

- Colour: red
- Shape: rectangular
- Mounting: adhesive



E-approved

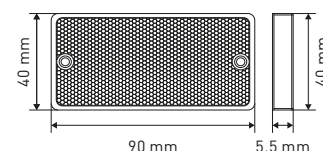

REF 150TA7958

- Colour: orange
- Shape: rectangular
- Mounting: screws
- Center distance: 79 mm



E-approved

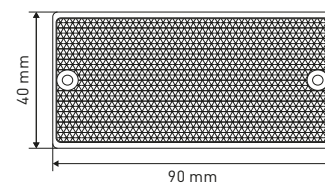

REF 150TA7948

- Colour: red
- Shape: rectangular
- Mounting: screws/adhesive
- Center distance: 79 mm



E-approved



REFLECTORS

REF 150TA8502

- Colour: red
- Shape: rectangular
- Mounting: screws
- Center distance: 70 mm

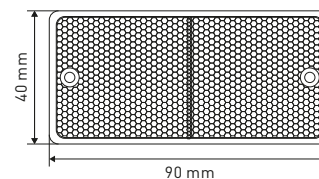

E-approved

TOTAL SOURCE[®]

REF 150TA8400

- Colour: white
- Shape: rectangular
- Mounting: screws
- Center distance: 70 mm

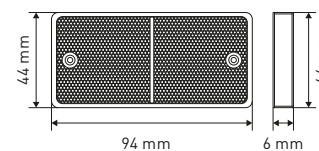

E-approved



REF 152TA1649

- Colour: white
- Shape: rectangular
- Mounting: screws
- Center distance: 70 mm

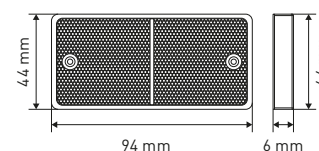
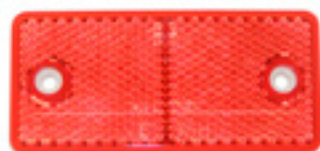

E-approved



REF 150TA7770

- Colour: red
- Shape: rectangular
- Mounting: screws
- Center distance: 45,5 mm
- Used on Deutz

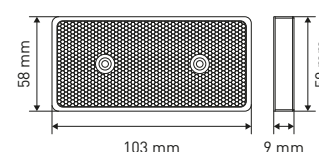

E-approved

TOTAL SOURCE[®]



REFLECTORS

REF 150TA7144

- Colour: red
- Shape: rectangular
- Mounting: one central screw M6
- Used on Nissan

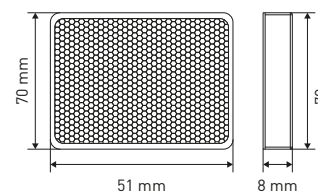

E-approved

TOTAL SOURCE®

REF 150TA9071

- Colour: red
- Shape: rectangular
- Mounting: screws M4
- Center distance: 50 mm

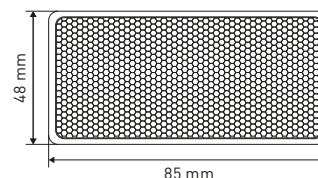

E-approved

TOTAL SOURCE®

REF 150TA7954

- Colour: red
- Shape: rectangular
- Mounting: screws
- Center distance: 115 mm

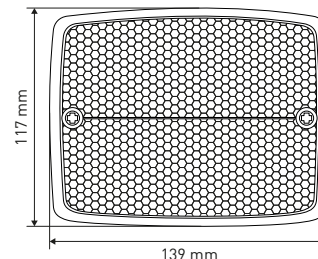

E-approved

TOTAL SOURCE®

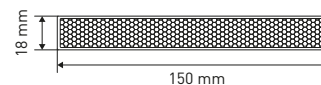

REF 150TA7055

- Colour: white
- Shape: rectangular
- Mounting: adhesive





REFLECTORS

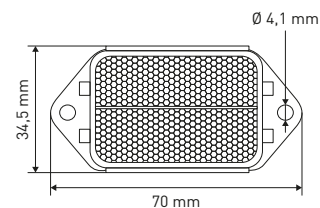

REF 150TA7796

- Colour: white
- Shape: rectangular
- Mounting: 2 screws
- Center distance: 60 mm

TOTAL SOURCE®

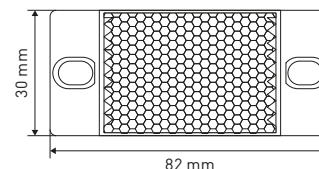

REF 150TA7930

- Colour: white
- Shape: rectangular
- Mounting: 2 screws
- Center distance: 69,5 mm

TOTAL SOURCE®

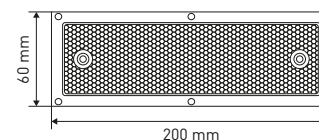

REF 150TA7798

- Colour: white
- Shape: rectangular
- Mounting: screws
- Center distance: 192 mm

TOTAL SOURCE®

E-approved

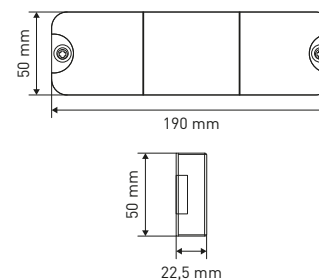

REF 150TA7044

- Colour: red
- Shape: rectangular
- Mounting: screws
- Center distance: 174 mm

TOTAL SOURCE®



REFLECTORS

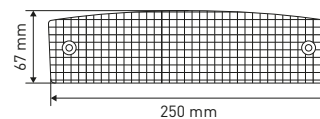

REF 150TA7520

- Colour: red
- Shape: rectangular
- Mounting: screws
- Center distance: 210 mm

TOTAL SOURCE®

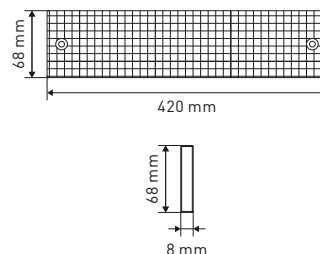

REF 152TA1647

- Colour: red
- Shape: rectangular
- Mounting: screws
- Center distance: 378 mm

TOTAL SOURCE®

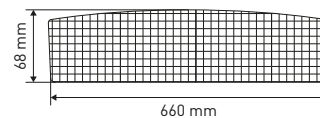

REF 150TA7521

- Colour: red
- Shape: rectangular
- Mounting: internal

TOTAL SOURCE®

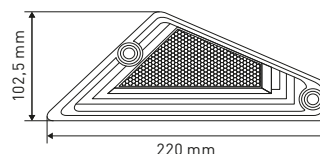

REF 150TA8911 – LH

REF 150TA8910 – RH

- Colour: red
- Shape: special
- Mounting: screws
- Center distance: 147 mm

E-approved

TOTAL SOURCE®



REFLECTORS

REF 150TA8808

- Colour: red
- Shape: triangular
- Mounting: screws
- center distance: 70 mm

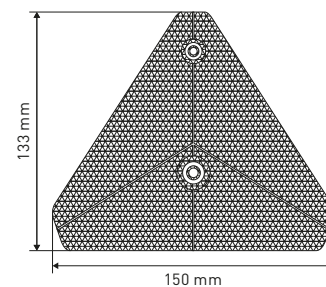

E-approved

TOTAL SOURCE[®]

REF 152TA1650

- Colour: red
- Shape: triangular
- Mounting: screws
- Center distance: 70 mm

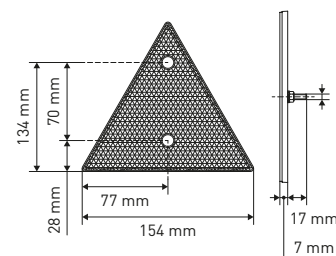
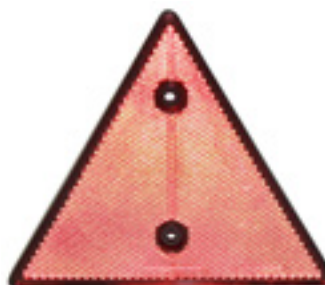

E-approved

TOTAL SOURCE[®]

- REF 150TA7832 – White
- REF 152TA1653 – Orange
- REF 152TA1645 – Red

- Colour: white
- Shape: round
- Mounting: adhesive

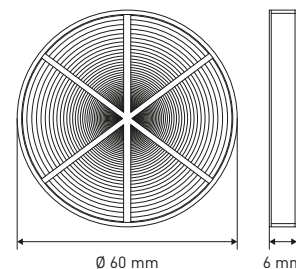

E-approved

REF 150TA7802

- Colour: red
- Shape: round
- Mounting: adhesive

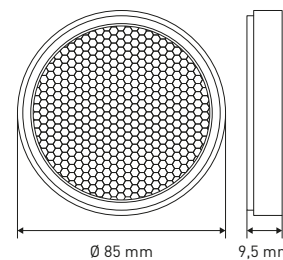

E-approved



REFLECTORS

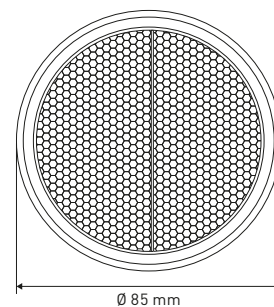

REF 150TA8168

- Colour: orange
- Shape: round
- Mounting: adhesive

E-approved

TOTAL SOURCE®

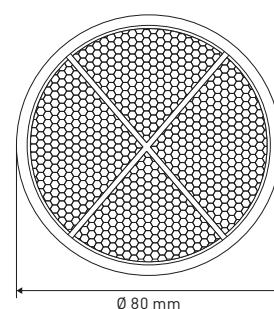

REF 151TA5978

- Colour: red
- Shape: round
- Mounting: adhesive

E-approved

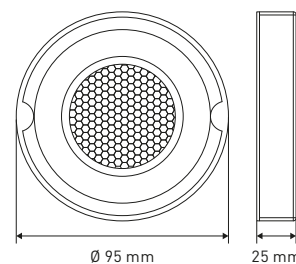

REF 150TA8062

- Colour: red
- Shape: round
- Mounting: screws
- Center distance: 80 mm

E-approved

TOTAL SOURCE®

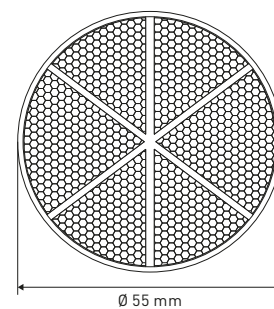

REF 152TA1648

- Colour: red
- Shape: round
- Mounting: one central screw M5

E-approved



REFLECTORS

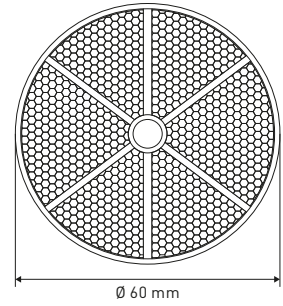

REF 150TA7064

- Colour: red
- Shape: round
- Mounting: screw

E-approved

TOTAL SOURCE[®]

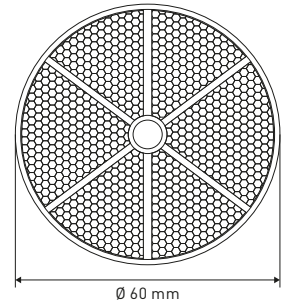

REF 152TA1656

- Colour: orange
- Shape: round
- Mounting: screw

E-approved

TOTAL SOURCE[®]

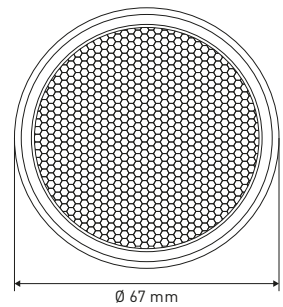

REF 150TA8828

- Colour: red
- Shape: round
- Mounting: screw

TOTAL SOURCE[®]

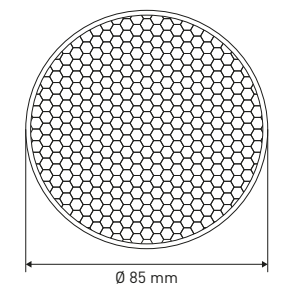

REF 150TA7511

- Colour: red
- Shape: round
- Mounting: screw

E-approved





REFLECTORS

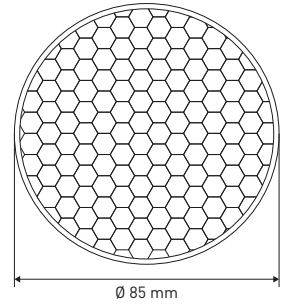

REF 150TA7820

- Colour: red
- Shape: round
- Mounting: screw

TOTAL SOURCE®

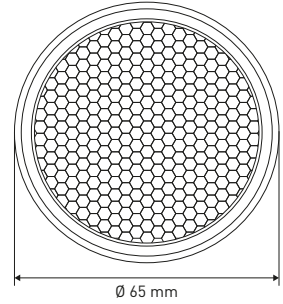

REF 150TA7790

- Colour: red
- Shape: round
- Mounting: screw





REFLECTORS

REF 164TA5483

- Dimensions (L x W): 423 x 423 mm
- Zinc plated metal

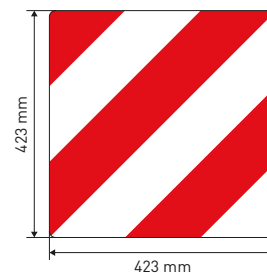

German parking panel

TOTAL SOURCE[®]

REF 164TA5484

- Panel indicating agricultural equipment
- Dimensions (L x W): 423 x 423 mm
- Zinc plated metal

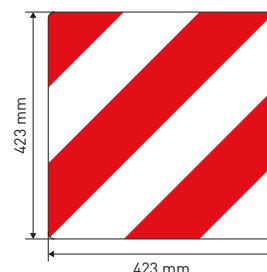

DIN 11050 – class 1 film

TOTAL SOURCE[®]

REF 144TA5880

- Kit of 2 right and left square panels, with reflecting red and white film class 1 – homologated TPESC
- Regulations for French agricultural vehicles
- Dimensions (L x W): 423 x 423 x 1 mm
- Material: aluminium

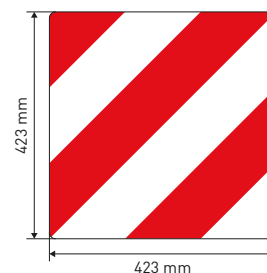

TPESC – class 1 film

TOTAL SOURCE[®]



WARNING REFLECTORS

- REF 152TA2237** – Alu panel set 2 pcs
REF 164TA6489 – Vinyl kit 2 trailer decals
- Aluminium kit 2 trailer panels
 - Panels \geq 3500 kg
 - ECE 70 01
 - Panel or decal: reflecting/fluorescent
 - Dimensions (L x W x H): 565 x 196 x 1 mm

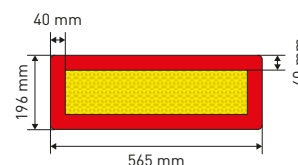

Trailer panels

TOTAL SOURCE[®]

- REF 163TA6806**
- Single panel \geq 3500 kg
 - ECE 70 01
 - Panel reflecting/reflecting
 - Dimensions (L x W x H): 1130 x 196 x 1 mm

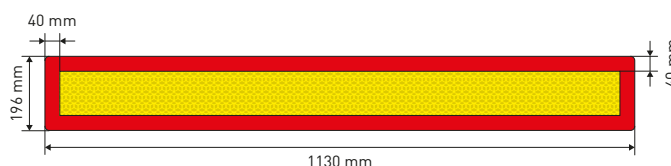

Trailer panels

TOTAL SOURCE[®]

- REF 152TA2236** – Aluminium – kit 2 truck panels
REF 164TA6490 – Vinyl – kit 2 truck decals
- Panel \geq 3500 kg
 - ECE 70 01
 - Panel reflecting/reflecting
 - Dimensions (L x W x H): 565 x 196 x 1 mm



Truck panels

TOTAL SOURCE[®]



MARKER LIGHTS



NICE TO KNOW – MARKER LIGHTS



Marker lights are used to inform the surroundings of the length and width of the vehicle and its potential load. These lights are attached to the side of the vehicle and to a potential load or trailer. Some models can be used on both sides of the vehicle, these are mainly orange side markers. In addition, there are also models with a rubber intermediate section in which the red and white lens can be exchanged and be mounted on both sides. The lights are mounted with screws, either with a rubber spacer or without (depending on the design of the light). Both LED marker lights and marker lights with incandescent bulbs are available.



MARKER LIGHTS

REF 151TA3161 – 12-24V

- Technology: incandescent
- Mounting: 2 bolts
- Center distance: 45 mm
- Function: position and turn function
- Bulbs not included

REF 103TA4537 – Bulb: SV8,5-8 12V 5W

REF 122TA9113 – Bulb: BA15S 12V 21W

REF 103TA4539 – Bulb: SV8,5-8 24V 5W

REF 103TA4603 – Bulb: BA15S 24V 21W

REF 150TA3704 – Replacement lens

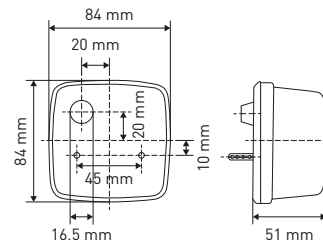

E-approved

REF 151TA3323 – 12-24V white

- Technology: incandescent
- Mounting: 2 bolts
- Center distance: 45 mm
- Bulb not included

REF 122TA9113 – Bulb: BA15S 12V 21W

REF 131TA4772 – Bulb: BA15S 24V 18W

REF 151TA3324 – Replacement lens

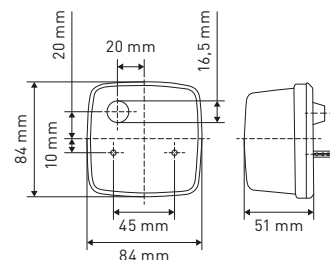
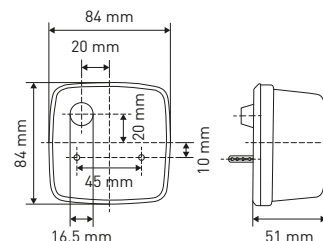

REF 161TA5992 – 12-24V red

- Technology: incandescent
- Mounting: 2 bolts
- Center distance: 45 mm
- Bulb not included

REF 122TA9113 – Bulb: BA15S 12V 21W

REF 131TA4772 – Bulb: BA15S 24V 18W





MARKER LIGHTS

REF 151TA3331 – Bulbs not included

REF 151TA3271 – 12V

- Technology: incandescent
- Mounting: 2 bolts
- Center distance: 45 mm
- Bulbs included

REF 123TA7982 – Bulb: BA15S 12V 5W

REF 100TA2215 – Bulb: BA15S 12V 21W

REF 103TA4587 – Bulb: BA15S 24V 5W

REF 103TA4603 – Bulb: BA15S 24V 21W

REF 151TA3272 – Replacement lens

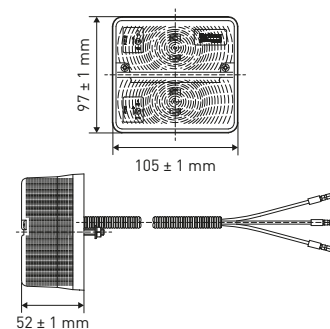

E-approved

TOTAL SOURCE®

REF 151TA3311 – 12-24V

- Technology: incandescent
- Mounting: 2 bolts
- Center distance: 58 mm
- Bulbs not included

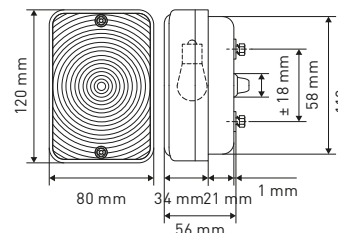

REF 100TA2215 – Bulb: BA15S 12V 21W

REF 123TA7982 – Bulb: BA15S 12V 5W

REF 103TA4603 – Bulb: BA15S 24V 21W

REF 103TA4587 – Bulb: BA15S 24V 5W

REF 151TA3312 – Replacement lens

E-approved

COBO
grow

REF 151TA3313 – 12V

- Technology: incandescent
- Mounting: 2 bolts
- Wire length: 250 mm
- Bulbs included
- Used for Nissan
- Connector: type 4, F1 and type 8

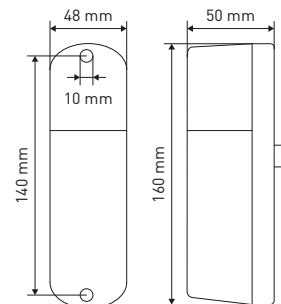

REF 100TA2191 – Bulb: BA15S 12V 10W

REF 103TA4602 – Bulb: BA15S 12V 25W

REF 151TA3314 – Replacement lens

REF 151TA2994 – Bracket

TOTAL SOURCE®



MARKER LIGHTS

REF 151TA3262 – 12-24V

- Technology: incandescent
- Mounting: 2 bolts
- Center distance: 58 mm
- Bulbs not included

REF 115TA4601 – Bulb: BA9S 12V 5W

REF 100TA2215 – Bulb: BA15S 12V 21W

REF 103TA4577 – Bulb: BA9S 24V 4W

REF 103TA4603 – Bulb: BA15S 24V 21W

REF 150TA4943 – Replacement lens

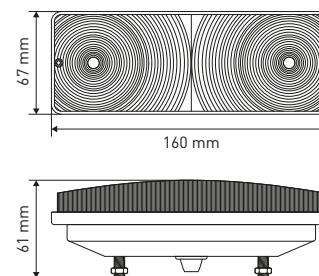

E-approved

REF 151TA3315 – 12V

- Technology: incandescent
- Mounting: 2 bolts
- Center distance: 133 mm
- Wire length: 220 mm
- Bulbs included
- Connector: 2 x F1 and G1

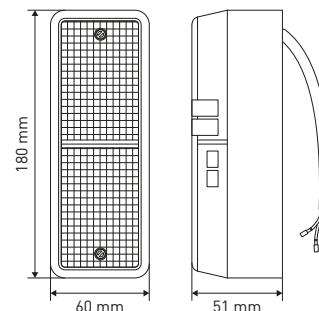

E-approved

REF 103TA4585 – Bulb: BA15S 12V 5W

REF 100TA2215 – Bulb: BA15S 12V 21W

REF 150TA1016 – Replacement lens

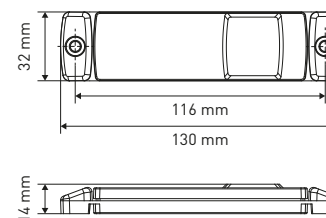

REF 149TA2888 – 12-24V

- Technology: LED
- Mounting: 2 bolts
- Center distance: 116 mm
- Wire length: 500 mm
- Colour: orange
- Function: side reflex



MARKER LIGHTS

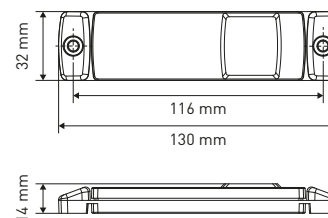

REF 149TA2889 – 12-24V

- Technology: LED
- Mounting: 2 bolts
- Center distance: 116 mm
- Wire length: 500 mm
- Colour: white
- Function: front reflex

TOTAL SOURCE®

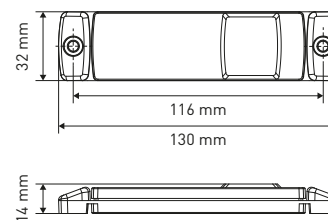

REF 149TA2890 – 12-24V

- Technology: LED
- Mounting: 2 bolts
- Center distance: 116 mm
- Wire length: 500 mm
- Colour: orange
- Function: rear reflex

TOTAL SOURCE®

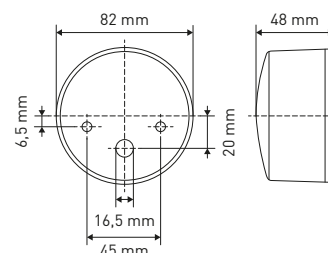

REF 151TA3162 – 12-24V

- Technology: incandescent
- Mounting: 2 bolts
- Center distance: 45 mm
- Lens: plastic
- Bulbs not included

REF 103TA4537 – Bulb: SV8,5-8 12V 5W

REF 122TA9113 – Bulb: BA15S 12V 21W

REF 103TA4539 – Bulb: SV8,5-8 24V 5W

REF 103TA4603 – Bulb: BA15S 24V 21W

REF 150TA4732 – Replacement lens





MARKER LIGHTS

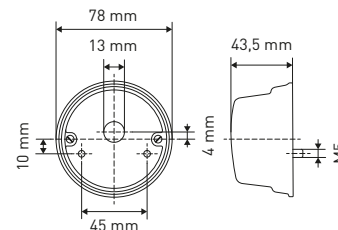

REF 151TA3318

- Type of technology: incandescent
- Mounting: 2 bolts
- Center distance: 45 mm
- Bulbs not included
- 12V

REF 103TA4541 – Bulb: SV8,5-8 12V 18W

REF 103TA4533 – Bulb: SV7-8 12V 3W

REF 151TA3319 – Replacement lens

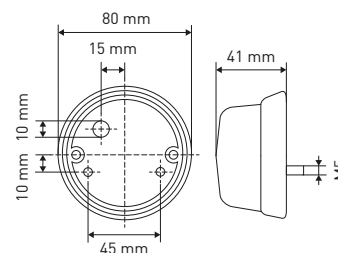

REF 151TA3265

- Technology: incandescent
- Mounting: 2 bolts
- Center distance: 45 mm
- Bulbs not included
- 12-24V
- Green

Amber version, see page 43 (REF 151TA3944)

Red version, see page 126 (REF 151TA5982)

REF 106TA4833 – Bulb: SV8,5-8 24V 18W

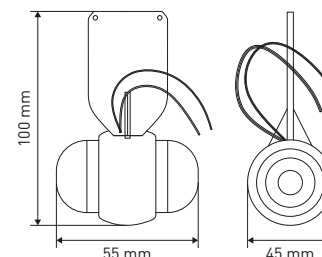

REF 163TA8597 – 12-24V

- Technology: LED (red/white)
- Mounting: 2 bolts
- Center distance: 32 mm
- Wire length: 350 mm
- IP67
- Certified CE R7





MARKER LIGHTS

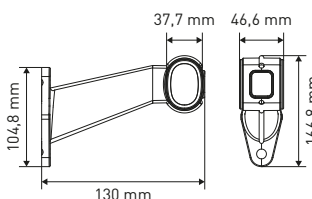

REF 149TA2893 – 12-24V

- Technology: LED
- Mounting: 2 bolts
- Center distance: 78 mm
- Wire length: 300 mm

TOTAL SOURCE[®]



1 Pull

2 Turn

3 Push

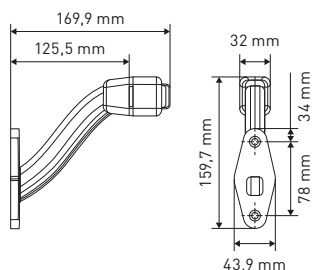

REF 149TA2894 – 12-24V

- Technology: LED
- Mounting: 2 bolts
- Center distance: 78 mm
- Wire length: 300 mm

TOTAL SOURCE[®]

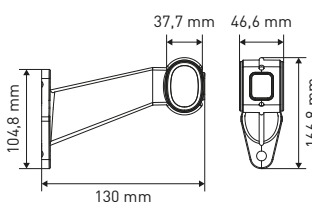

REF 149TA2891 – 12-24V LH

REF 149TA2892 – 12-24V RH

- Technology: LED
- Mounting: 2 bolts
- Wire length: 500 mm

TOTAL SOURCE[®]



MARKER LIGHTS

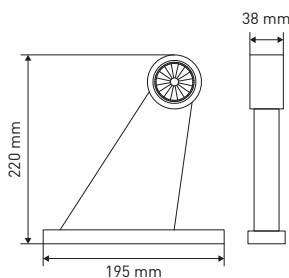

REF 163TA8598 – 10–30V

- Technology: LED
- Mounting: 2 bolts
- Center distance: 78 mm
- Wire length: 350 mm
- IP67

TOTAL SOURCE®

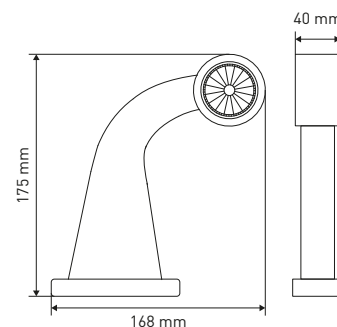

REF 163TA8599 – 10–30V

- Technology: LED
- Mounting: 2 bolts
- Center distance: 78 mm
- Wire length: 300 mm
- IP67
- Lenses are interchangeable

TOTAL SOURCE®

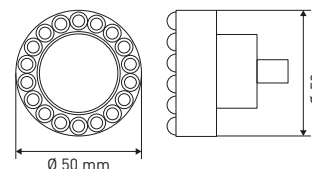

REF 151TA6121 – Green

REF 151TA6128 – Red

REF 148TA4052 – Yellow

- Technology: LED
- Mounting: central bolt
- 12–30V
- Connector pins: 4
- Bulb not replaceable
- Used on Kalmar, container spreader

TOTAL SOURCE®



LED MARKER 4-PIN

- REF 151TA6112** – Green
- REF 151TA6113** – Red
- REF 151TA6115** – Yellow
- REF 151TA6117** – Blue
- REF 151TA6119** – White

- Technology: LED
- Mounting: central bolt
- 12–30V
- Connector pins: 4
- Used on Bromma

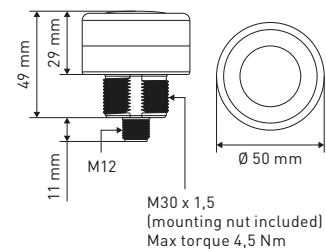

TOTAL SOURCE[®]

LED MARKER 3-PIN

- REF 151TA6111** – Green
- REF 151TA6114** – Red
- REF 151TA6116** – Yellow
- REF 151TA6118** – Blue
- REF 151TA6120** – White

- Technology: LED
- Mounting: central bolt
- 90–240V
- Connector pins: 3
- Used on Bromma

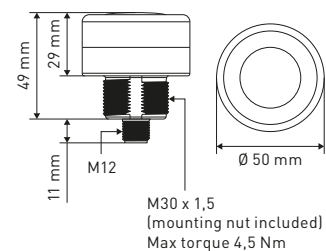

TOTAL SOURCE[®]



LICENSE PLATE LIGHTS



NICE TO KNOW – LICENSE PLATE LIGHTS



It is important to be able to visibly identify a vehicle.

Number plate lighting can be installed as a loose module, but is sometimes also installed in the rear light. This lighting must always be lit simultaneously with the main beam headlights, dimmed headlights, parking lights or fog lights of the rear lighting.

It is available in LED technology and as a model equipped with an incandescent bulb.

The number plate lighting can't illuminate the side of the vehicle, nor an area behind the vehicle.



LICENSE PLATE LIGHTS

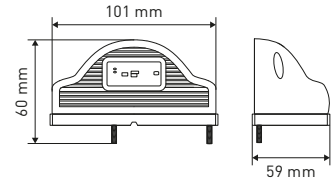

REF 163TA8596 – 12-24V

- Technology: LED
- Mounting: 2 bolts
- Center distance: 71 mm
- Wire length: 500 mm
- IP68
- Certified CE R7

E-approved

TOTAL SOURCE®

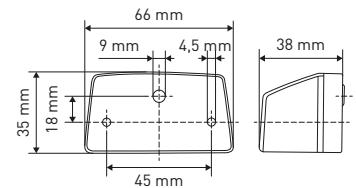

REF 151TA6039 – 12V

- Technology: incandescent
- Mounting: 2 bolts
- Center distance: 43 mm
- Wire length: 135 mm
- Bulb included
- Connector: Deutsch

REF 103TA4537 – Bulb: SV8,5-8 12V 5W

E-approved

TOTAL SOURCE®

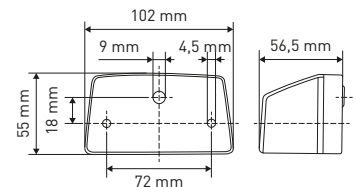

REF 151TA6097

- Technology: incandescent
- Mounting: 2 holes
- Center distance: 72 mm
- 12-24V
- Bulb not included

REF 100TA2190 – Bulb: BA15S 12V 5W

REF 103TA4587 – Bulb: BA15S 24V 5W

REF 150TA6407 – Replacement lens

E-approved





LICENSE PLATE LIGHTS

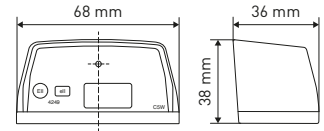

- REF 148TA2024** – 12V
- Technology: incandescent
 - Mounting: 2 bolts
 - Center distance: 45 mm
 - Bulb included

REF 103TA4537 – Bulb: SV8,5-8 12V 5W

E-approved

TOTAL SOURCE®

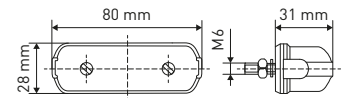

- REF 151TA6070**
- Technology: incandescent
 - Mounting: 2 bolts
 - Center distance: 45 mm
 - 12-24V
 - Bulb not included

REF 100TA2118 – Bulb: SV8,5-8 12V 5W

REF 106TA4829 – Bulb: SV8,5-8 24V 10W

E-approved

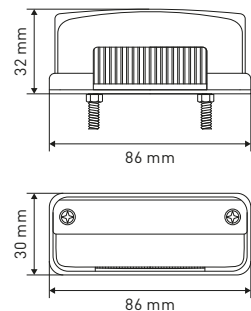

- REF 151TA6098**
- Technology: incandescent
 - Mounting: 2 bolts
 - Center distance: 44 mm
 - 12-24V
 - Bulb not included

REF 100TA2118 – Bulb: SV8,5-8 12V 5W

REF 106TA4829 – Bulb: SV8,5-8 24V 10W

E-approved





SAFETY LIGHTS

NICE TO KNOW – SAFETY LIGHTS



Safety lights warn bystanders of the presence of an approaching machine by means of a visual warning signal. The blue spot and red spot warning lights project a blue/red spot or arrow onto the floor, a few metres in front of or behind the machine (depending on where it was installed). In addition, there is also a 'red zone' light that projects a solid line onto the floor to mark a forbidden zone alongside a vehicle. By combining these lights, a complete area can be surrounded by using light.



BLUE SPOT LIGHTS

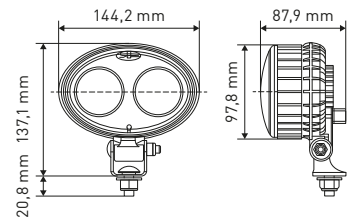
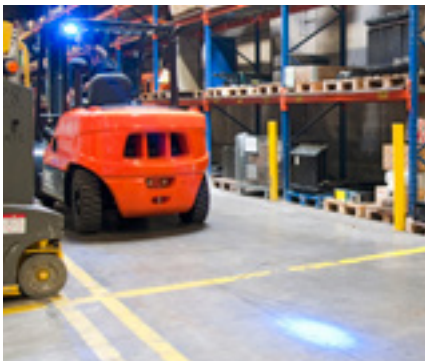

REF 147TA3431 – 12-110V

- Technology: LED 2 pieces
- Mounting: pedestal M10
- Colour: blue
- Nominal power: 10W
- IP67
- Connector: J2 built-in

TOTAL SOURCE[®]

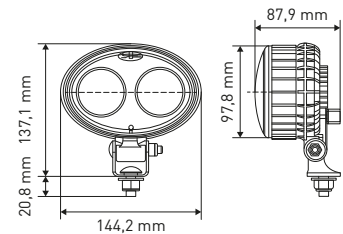

REF 140TA2243 – 12-110V

- Technology: LED 2 pieces
- Mounting: pedestal M10
- Colour: blue
- Nominal power: 10W
- IP67
- Connector: J2 built-in

TOTAL SOURCE[®]

BRAND: SPEAKER

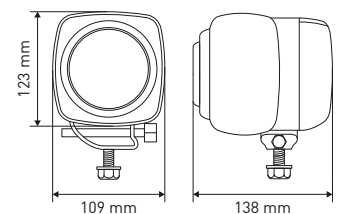

REF 141TA6749 – 12-100V

- Technology: LED 1 piece
- Mounting: pedestal M10
- Colour: blue
- Nominal power: 6W
- IP68
- Connector: J2 built-in

ABL



BLUE SPOT LIGHTS

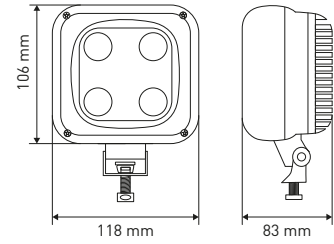

- REF 152TA1662** – 12-48V
- Technology: LED 4 pieces
 - Mounting: pedestal M10
 - Colour: blue
 - Wire length: 1020 mm
 - Nominal power: 15W
 - IP69
 - Connector: J2 built-in



BLUE ARROW SPOT LIGHT

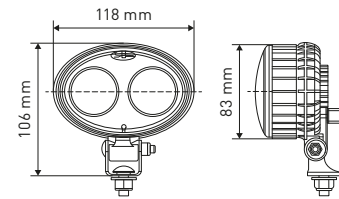

- REF 148TA8124** – 12-48V
- Technology: LED 2 pieces
 - Mounting: pedestal M10
 - Colour: blue arrow spot
 - Wire length: 1020 mm
 - Nominal power: 15W
 - IP69
 - Connector: J2 built-in





RED SPOT LIGHTS



REF 148TA9614 – 12-110V

- Technology: LED 2 pieces
- Mounting: pedestal M10
- Colour: red
- Nominal power: 10W
- IP67
- Connector: J2 built-in

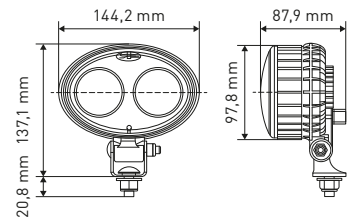

TOTAL SOURCE[®]

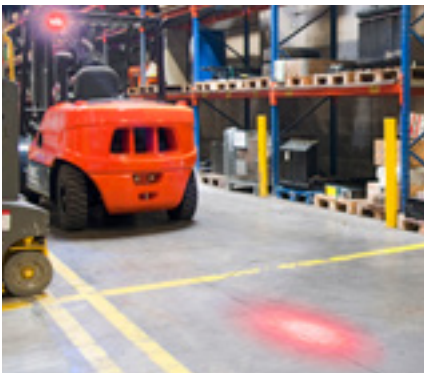

REF 141TA6748 – 12-80V

- Technology: LED 2 pieces
- Mounting: pedestal M10
- Colour: red
- Nominal power: 10W
- IP67
- Connector: J2 built-in

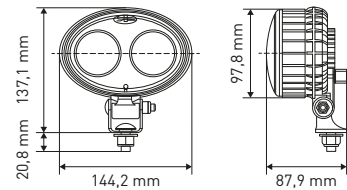

TOTAL SOURCE[®]

BRAND: SPEAKER



RED SAFETY ZONE WARNING LIGHT

NEW!

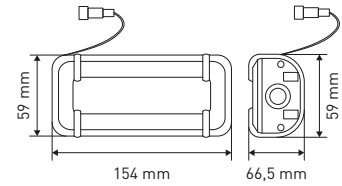

- REF 163TA8854** – 9–60V
- Technology: LED 6 pieces
 - Mounting: brackets
 - Colour: red line
 - Nominal power: 30W
 - IP67

One light needed on each side

TOTAL SOURCE[®]

BLUE SAFETY ZONE WARNING LIGHT

NEW!

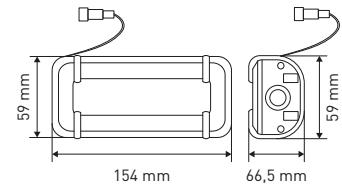

- REF 164TA9700** – 9–60V
- Technology: LED 6 pieces
 - Mounting: brackets
 - Colour: blue line
 - Nominal power: 30W
 - IP67

One light needed on each side

TOTAL SOURCE[®]



WORK LIGHTS



NICE TO KNOW – WORK LIGHTS



Work lights are used to illuminate the work area. These can only be used off-road and can't be used on public roads. Work lights are available with LED technology as well as with halogen, xenon, and incandescent bulb technology, in square, rectangular or round shape.

LED work lights

LED work lights are split up into 2 types:

- Flood beam: illuminates a wide area over a short distance
- Spot beam: illuminates a long, narrow area over a longer distance. The intensity of the light is higher in comparison with a flood beam light.

The light output of LED work lights is indicated in a value of lumen. The flood beam worklight is most common and most used. If a worklight has a spot beam or is available in both versions, this will be mentioned in the title or specifications. In all other situations the light shown will have a flood beam.

Advantages of LED

- Long lifespan: up to 100x the lifespan of a halogen bulb
- Maintenance-free
- Low power consumption
- Waterproof
- Vibration-resistant
- Robust

Halogen/incandescent bulb work lights

For work lights that use halogen or incandescent bulb technology, the light output isn't expressed in lumen but the power of the used bulb is stated. This means there are different voltages possible as well, all possible replacement bulbs are listed as spare part. In order to be able to compare the light output in lumen to the wattage of an incandescent bulb, you can use below table:

Lumen	Incandescent bulb (wattage)	Fluorescent lamp (wattage)	LED (wattage)
450	40	± 10	± 8
850	60	± 15	± 10
1500	80-85	± 20	± 15
1800	100	± 25	± 18
2800	150	± 45	± 27

Installation

There are models that require either a standing (pedestal) or a hanging (pendant) installation. Some work lights even require a lateral installation.

Flood beam

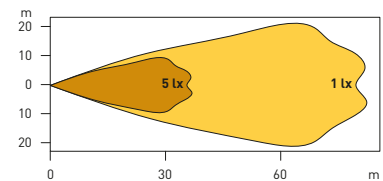

Spot beam

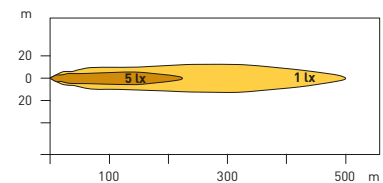



FLOOD/SPOT WORK LIGHTS

REF 152TA1657 – 12-48V

REF 152TA1658 – 12-80V

- Technology: LED 4 pieces
- Mounting: pedestal M12
- Wire length: 300 mm
- Theoretical output: 850 lumen
- Operating light output: 450 lumen
- Nominal power: 8,5W
- IP66

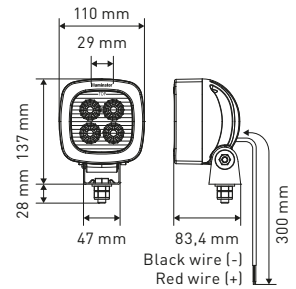

Illuminator®

SPOT WORK LIGHTS

REF 152TA1659 – 9-32V

- Technology: LED
- Mounting: pedestal M8
- Wire length: 400 mm
- Theoretical output: 900 lumen
- Operating light output: 680 lumen
- Nominal power: 10W
- IP67

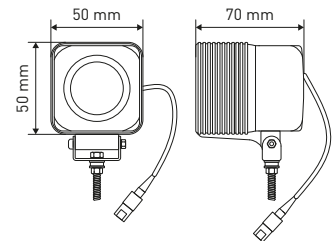

TOTAL SOURCE®

REF 152TA1661 – 10-48V

- Technology: LED 4 pieces
- Mounting: pedestal M10
- Wire length: 510 mm
- Theoretical light output: 2100 lumen
- Operating light output: 1600 lumen
- Nominal power: 20W
- IP67

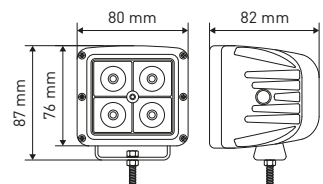

TOTAL SOURCE®



FLOOD/SPOT WORK LIGHTS

REF 152TA1694 – Flood beam

REF 152TA1695 – Spot beam

- Technology: LED 5 pieces
- Mounting: pedestal M8
- Extra: 4-point bracket included
- Wire length: 395 mm
- 9–32V
- Theoretical output: 900 lumen
- Operating light output: 675 lumen
- Nominal power: 15W
- IP68

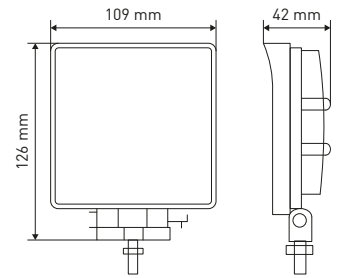

TOTAL SOURCE®

REF 152TA1701 – Flood beam

- Technology: LED 5 pieces
- Mounting: pedestal M10
- Extra: 4-point bracket included
- Wire length: 460 mm
- 9–32V
- Theoretical output: 900 lumen
- Operating light output: 675 lumen
- Nominal power: 15W
- IP67

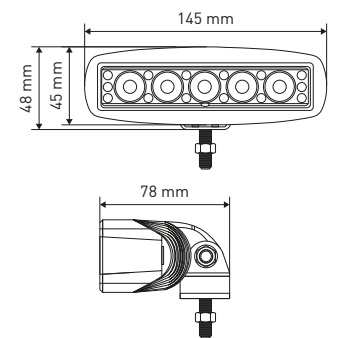

TOTAL SOURCE®

REF 152TA1700 – Flood beam

- Technology: LED 12 pieces
- Mounting: pedestal M8
- Wire length: 185 mm
- 12–48V
- Theoretical output: 900 lumen
- Operating light output: 750 lumen
- Nominal power: 24W
- IP67

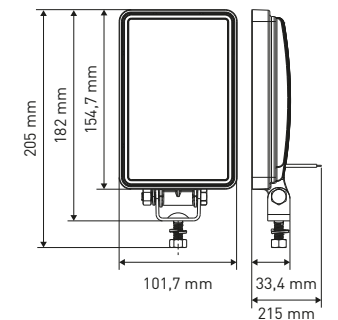

TOTAL SOURCE®

REF 152TA1666 – Flood beam

- Technology: LED
- Mounting: pedestal M8
- Wire length: 5000 mm
- 12–48V
- Theoretical output: 900 lumen
- Operating light output: 600 lumen
- Nominal power: 38W
- IP69

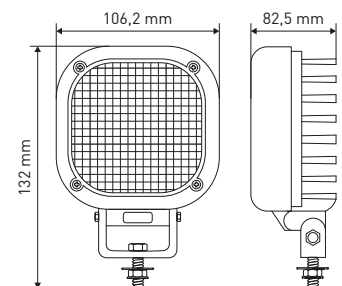

TYRI



FLOOD/SPOT WORK LIGHTS

REF 152TA1660 – 10–30V

- Technology: LED 12 pieces
- Mounting: pedestal M10
- Theoretical output: 1000 lumen
- Operating light output: 850 lumen
- Nominal power: 11W
- IP68
- Connector: J2

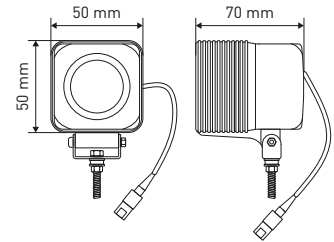

REF 152TA1663 – 12–80V

- Technology: LED 4 pieces
- Mounting: pedestal M10
- Theoretical light output: 1100 lumen
- Operating light output: 750 lumen
- Nominal power: 17W
- IP68
- Connector: E2 built-in

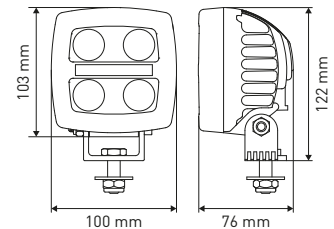

REF 152TA1664 – 12–100V

- Technology: LED 5 pieces
- Mounting: pedestal M10
- Theoretical light output: 1200 lumen
- Operating light output: 1000 lumen
- Nominal power: 20W
- IP68
- Connector: J2 built-in

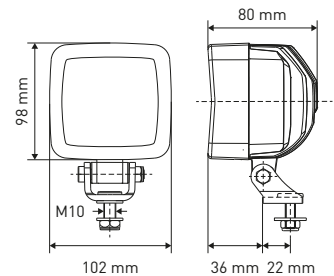

REF 152TA1698 – Flood beam

REF 152TA1699 – Spot beam

- Technology: LED 9 pieces
- Mounting: pedestal M10
- Extra: 4-point bracket included
- Wire length: 475 mm
- 10–30V
- Theoretical output: 1650 lumen
- Operating light output: 1226 lumen
- Nominal power: 27W
- IP68

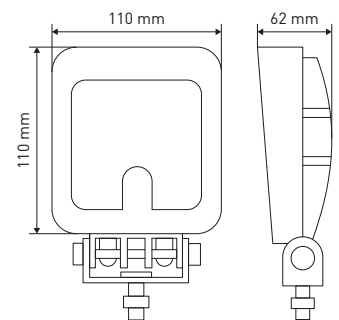



FLOOD/SPOT WORK LIGHTS

REF 152TA1668 – Flood beam

REF 152TA1669 – Spot beam

- Technology: LED 4 pieces
- Mounting: pedestal M10
- Wire length: 460 mm
- 9–40V
- Theoretical output: 4000 lumen
- Operating light output: 2800 lumen
- Nominal power: 40W
- IP68

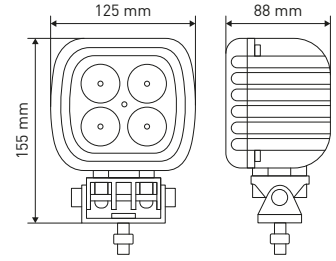

TOTAL SOURCE[®]

REF 152TA1670 – Flood beam

REF 152TA1671 – Spot beam

- Technology: LED 16 pieces
- Mounting: pedestal M10
- Wire length: 465 mm
- 12–30V
- Theoretical output: 4800 lumen
- Operating light output: 3450 lumen
- Nominal power: 48W
- IP68

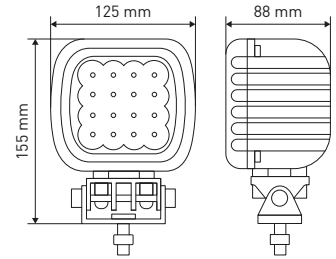

TOTAL SOURCE[®]

REF 152TA1690 – Flood beam

REF 152TA1691 – Spot beam

- Technology: LED 10 pieces
- Mounting: pendant
- 12–24V
- Theoretical output: 6700 lumen
- Operating light output: 4200 lumen
- Nominal power: 50W
- IP68
- Connector: E2 built-in
- Heavy-duty damping

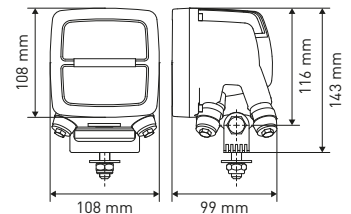

TOTAL SOURCE[®]

BRAND: NORDIC LIGHTS

REF 143TA7877 – Flood beam

REF 143TA7878 – Spot beam

- Technology: LED 8 pieces
- Mounting: pedestal M10
- Extra: 4-point bracket included
- 24V
- Theoretical output: 9600 lumen
- Operating light output: 6000 lumen
- Nominal power: 85W
- IP68
- Connector: E2 built-in

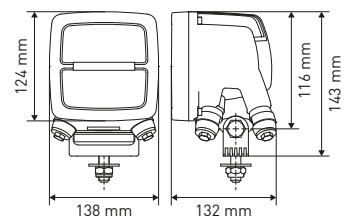

TOTAL SOURCE[®]

BRAND: NORDIC LIGHTS



FLOOD/SPOT WORK LIGHTS

REF 152TA1704 – Vertical oval

REF 152TA1705 – Horizontal oval

- Technology: LED 6 pieces
- Mounting: pedestal M8
- Wire length: 320 mm
- 12–48V
- Theoretical output: 900 lumen
- Operating light output: 700 lumen
- Nominal power: 12W
- IP67

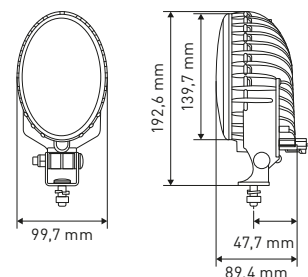

TOTAL SOURCE®

BRAND : SPEAKER

REF 152TA1706 – 12–48V round

REF 152TA1707 – 12–80V round

- Technology: LED 4 pieces
- Mounting: pedestal M12
- Wire length: 290 mm
- Theoretical output: 800 lumen
- Operating light output: 450 lumen
- Nominal power: 12W
- IP66

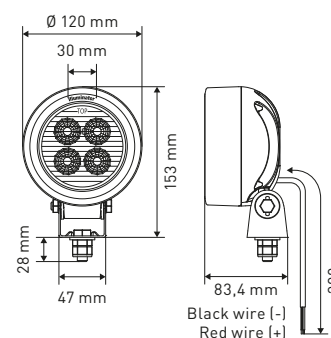

Illuminator®

REF 152TA1708 – 9–60V

- Technology: LED
- Mounting: pedestal M10
- Extra: handlebar mount included
- Wire length: 450 mm
- Theoretical output: 1000 lumen
- Operating light output: 750 lumen
- Nominal power: 10W
- IP68

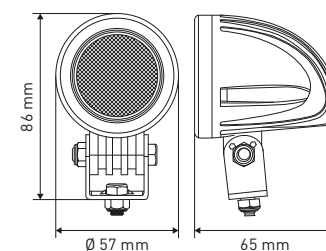

TOTAL SOURCE®

REF 152TA1709 – 12–100V

- Technology: LED 4 pieces
- Mounting: pedestal M8
- Theoretical output: 1000 lumen
- Operating light output: 850 lumen
- Nominal power: 12W
- IP68
- Connector: E2 built-in

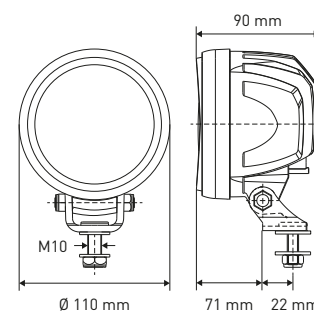

ABL



FLOOD/SPOT WORK LIGHTS

REF 152TA1712 – Flood beam 10–30V

REF 152TA1713 – Spot beam 10–30V

REF 152TA1715 – 12–48V

- Technology: LED 6 pieces
- Mounting: pedestal M10
- Extra: 4-point bracket included
- Wire length: 500 mm
- Theoretical output: 1080 lumen
- Operating light output: 810 lumen
- Nominal power: 18W
- IP68

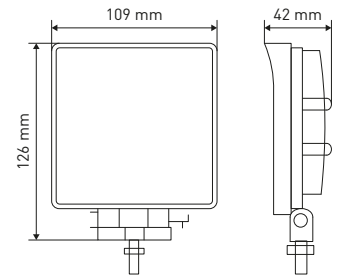

TOTAL SOURCE®

REF 152TA1716 – Flood beam

REF 152TA1717 – Spot beam

- Technology: LED 9 pieces
- Mounting: pedestal M10
- Extra: 4-point bracket included
- Wire length: 490 mm
- 9–32V
- Theoretical output: 1650 lumen
- Operating light output: 1226 lumen
- Nominal power: 27W
- IP68

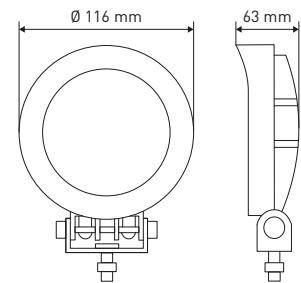

TOTAL SOURCE®

REF 152TA1710 – Flood beam

REF 152TA1711 – Spot beam

- Technology: LED 4 pieces
- Mounting: pedestal M8
- Wire length: 460 mm
- 9–40V
- Theoretical output: 4000 lumen
- Operating light output: 2800 lumen
- Nominal power: 40W
- IP68

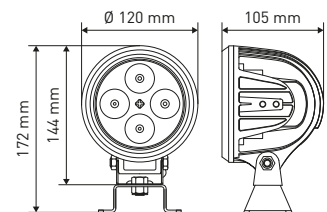

TOTAL SOURCE®

XENON HID WORK LIGHT

REF 152TA1720 – 12–24V

- Technology: xenon
- Mounting: pedestal M8
- Wire length: 1075 mm
- Nominal power: 35W
- Tube included (REF 164TA9408)

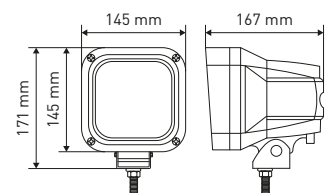

TOTAL SOURCE®



WORK LIGHTS

REF 147TA3112

- Technology: halogen
- Mounting: pedestal M10
- 12-24-36-48V
- IP67
- Bulb not included
- Connector: J2 built-in

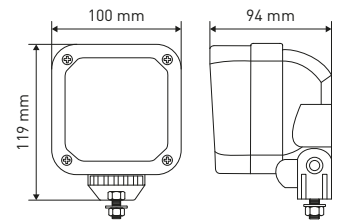

REF 161TA6105 – Bulb: H3 12V 55W

REF 161TA6106 – Bulb: H3 24V 70W

REF 142TA1218 – Bulb: H3 36V 45W

REF 144TA5499 – Bulb: H3 48V 45W

TOTAL SOURCE

BRAND: NORDIC LIGHTS

REF 152TA1895 – Without bulb

REF 152TA1896 – 12V

REF 152TA1897 – 24V

- Technology: halogen
- Mounting: pedestal M10
- IP66
- Bulb included

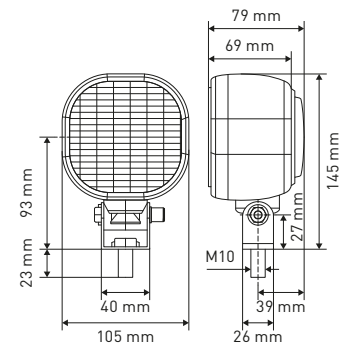

COBO
group

REF 123TA8007 – Bulb: H3 12V 55W

REF 123TA8008 – Bulb: H3 24V 70W

REF 152TA1726

- Technology: halogen
- Mounting: pedestal M10
- 12-24-36V
- IP54
- Bulb not included

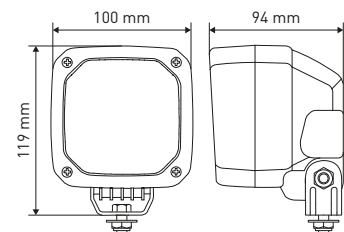

REF 161TA6105 – Bulb: H3 12V 55W

REF 161TA6106 – Bulb: H3 24V 70W

REF 142TA1218 – Bulb: H3 36V 45W

REF 152TA1727 – Small bracket

ABL

REF 152TA1876 – 24V

- Technology: halogen
- Mounting: pedestal M10
- Nominal power: 70W
- IP66-69K
- Bulb included
- Connector: E2 built-in

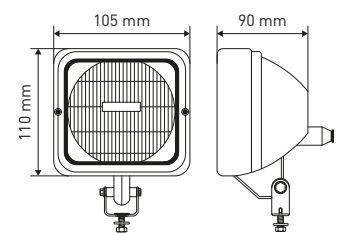

REF 161TA6106 – Bulb: H3 24V 70W

ABL



WORK LIGHTS

REF 152TA1672 – 12V

- Technology: halogen
- Mounting: side M8
- Nominal power: 55W
- IP69K
- Bulb included
- Connector: E2 built-in

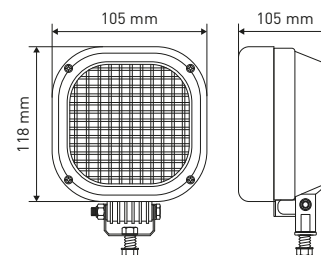

REF 161TA6105 – Bulb: H3 12V 55W

REF 152TA1877 – 12V

- Technology: halogen
- Mounting: side M8
- Nominal power: 55W
- IP69
- Bulb included
- Connector: E2 built-in

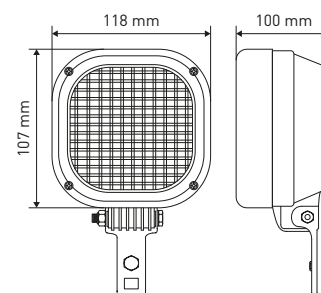

REF 161TA6105 – Bulb: H3 12V 55W

REF 152TA1879

- Technology: halogen
- Mounting: 4 point bracket
- 12–24V
- IP66
- Bulb not included
- Connector: J2 built-in

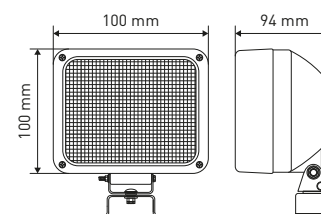

REF 161TA6004 – Bulb: H3 12V 55W

REF 123TA8008 – Bulb: H3 24V 70W

REF 152TA2449 – 12V

- Technology: halogen (spot)
- Mounting: pedestal M10
- Wire length: 350 mm
- Nominal power: 55W
- Bulb included

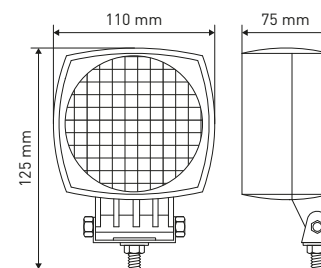

REF 161TA6105 – Bulb: H3 12V 55W



WORK LIGHTS

REF 152TA1880 – 12V without bulb

REF 152TA1884 – 24V

- Technology: halogen
- Mounting: pedestal M10
- IP5K9K
- Bulb not included
- Connector: E2 built-in

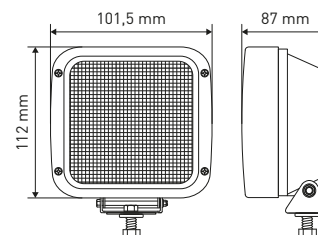

REF 123TA8007 – Bulb: H3 12V 55W

REF 123TA8008 – Bulb: H3 24V 70W

REF 152TA1882 – Without bulb

REF 152TA1883 – 12V

REF 152TA1881 – 24V

- Technology: halogen
- Mounting: pedestal M10
- IP6K9K
- Bulb included
- Connector: J2

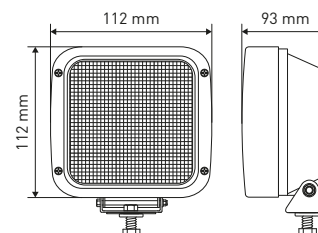

TOTAL SOURCE[®]

REF 123TA8007 – Bulb: H3 12V 55W

REF 123TA8008 – Bulb: H3 24V 70W

REF 152TA1885 – 12V

- Technology: halogen
- Mounting: pedestal M10
- Wire length: 250 mm
- Nominal power: 55W
- Bulb included

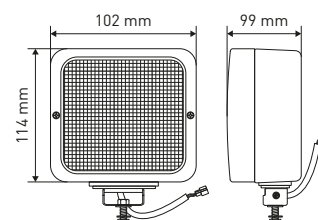

TOTAL SOURCE[®]

REF 123TA8007 – Bulb: H3 12V 55W

REF 152TA1886 – Without bulb

REF 152TA1887 – 12V

REF 148TA9047 – 24V

REF 148TA9048 – 36V

REF 148TA9049 – 48V

- Technology: halogen
- Mounting: pedestal M10
- Extra: 4 point bracket
- Wire length: 200 mm
- Bulb included

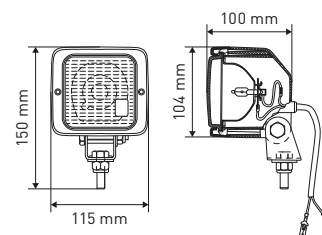

TOTAL SOURCE[®]

REF 161TA6105 – Bulb: H3 12V 55W

REF 161TA6106 – Bulb: H3 24V 70W

REF 144TA5547 – Bulb: H3 36V 45W

REF 144TA5499 – Bulb: H3 48V 45W



WORK LIGHTS

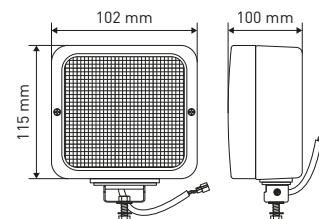

- REF 152TA1888** – 12V
- Technology: halogen
 - Mounting: pedestal M10
 - Wire length: 150 mm
 - Bulb included

REF 161TA6105 – Bulb: H3 12V 55W

TOTAL SOURCE®

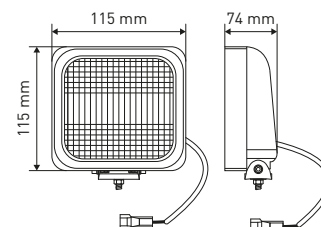

- REF 152TA1894** – 12V
- Technology: halogen
 - Mounting: pedestal M8
 - Wire length: 300 mm
 - Nominal power: 55W
 - Bulb included

REF 123TA8007 – Bulb: H3 12V 55W

TOTAL SOURCE®

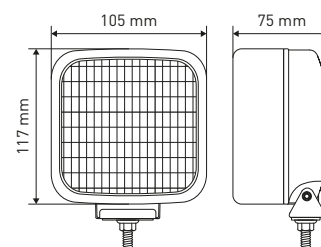

- REF 152TA1889** – 12V
- Technology: halogen
 - Mounting: pedestal M8
 - Wire length: 300 mm
 - Nominal power: 55W
 - Bulb included

REF 161TA6105 – Bulb: H3 12V 55W

REF 150TA1246 – Replacement lens

TOTAL SOURCE®

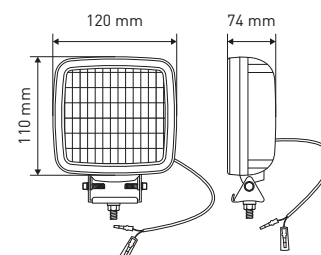

- REF 152TA1892** – 12V
- Technology: halogen
 - Mounting: pedestal M8
 - Wire length: 300 mm
 - Nominal power: 55W
 - IP64
 - Bulb included

REF 161TA6105 – Bulb: H3 12V 55W

TOTAL SOURCE®



WORK LIGHTS

REF 152TA1898 – 12V

- Technology: halogen
- Mounting: pedestal M12
- Wire length: 450 mm
- Nominal power: 55W
- Bulb included

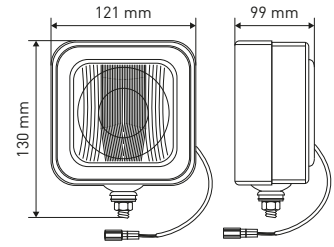

REF 123TA8007 – Bulb: H3 12V 55W

TOTAL SOURCE®

REF 152TA1900 – 12V

- Technology: incandescent
- Mounting: pedestal M8
- Wire length: 200 mm
- Nominal power: 35W
- Bulb included

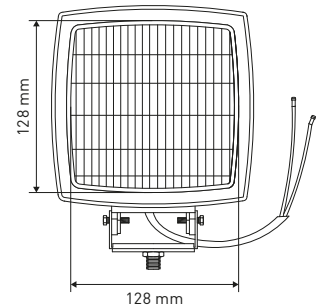

REF 144TA5443 – Bulb: BA15S 12V 35W

REF 151TA3214 – Replacement lens

TOTAL SOURCE®

REF 152TA1901 – 24V

- Technology: incandescent
- Mounting: pedestal M8
- Wire length: 200 mm
- Nominal power: 36W
- IP65
- Bulb included

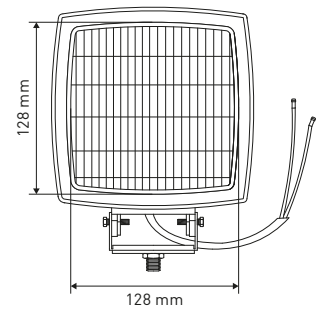

REF 141TA9856 – Bulb: BA15S 24V 36W

REF 151TA3214 – Replacement lens

TOTAL SOURCE®

REF 152TA2398 – 24V

- Technology: incandescent
- Mounting: pedestal M8
- Wire length: 250 mm
- Nominal power: 36W
- Bulb included

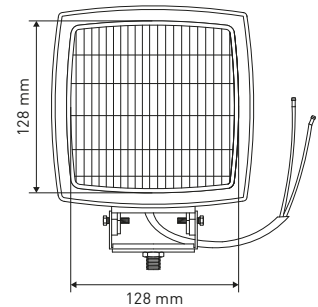

REF 141TA9856 – Bulb: BA15S 24V 36W

REF 151TA3214 – Replacement lens

TOTAL SOURCE®



WORK LIGHTS

REF [152TA2399](#) – Without bulb

REF [147TA6951](#) – 12V

REF [148TA9280](#) – 24V

REF [148TA9153](#) – 48V

REF [148TA9154](#) – 80V

- Technology: halogen
- Mounting: pedestal M8
- IP67
- Bulb included

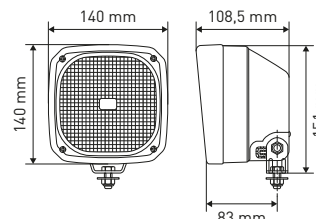

TOTAL SOURCE[®]

BRAND: NORDIC LIGHTS

REF [123TA8007](#) – Bulb: H3 12V 55W

REF [123TA8008](#) – Bulb: H3 24V 70W

REF [123TA8011](#) – Bulb: H3 48V 60W

REF [103TA4675](#) – Bulb: H3 80V 55W

REF [152TA1899](#) – 12V

REF [149TA2096](#) – 24V

- Technology: halogen
- Mounting: pedestal M8
- Wire length: 240 mm
- IP54
- Bulb not included

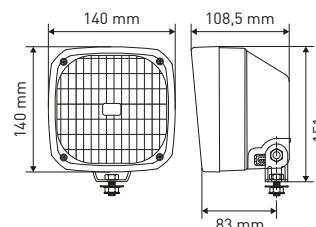

ABL

REF [123TA8007](#) – Bulb: H3 12V 55W

REF [123TA8008](#) – Bulb: H3 24V 70W

REF [152TA2422](#) – 12V

REF [152TA2423](#) – 24V

REF [152TA2424](#) – 48V

REF [152TA2425](#) – 80V

- Technology: halogen
- Mounting: pedestal M8
- Wire length: 300 mm
- Bulb included

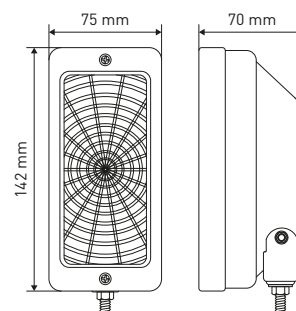

TOTAL SOURCE[®]

REF [161TA6105](#) – Bulb: H3 12V 55W

REF [161TA6106](#) – Bulb: H3 24V 70W

REF [144TA5499](#) – Bulb: H3 48V 45W

REF [103TA4675](#) – Bulb: H3 80V 55W

REF [152TA2426](#) – 12V

REF [152TA2427](#) – 24V

REF [152TA2428](#) – 48V

REF [152TA2429](#) – 80V

- Technology: halogen
- Mounting: pedestal M8
- Wire length: 300 mm
- Bulb included

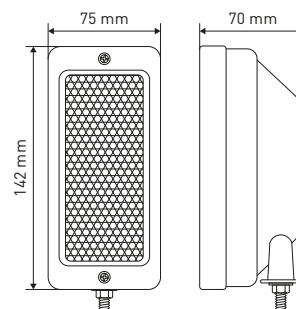

TOTAL SOURCE[®]

REF [161TA6105](#) – Bulb: H3 12V 55W

REF [161TA6106](#) – Bulb: H3 24V 70W

REF [144TA5499](#) – Bulb: H3 48V 45W

REF [103TA4675](#) – Bulb: H3 80V 55W



WORK LIGHTS

REF [152TA2434](#)

- Technology: halogen
- Mounting: pedestal M8
- 12–24V
- IP65
- Bulb not included

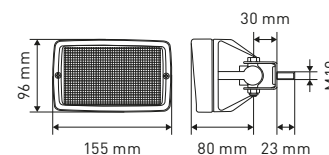

REF [123TA8007](#) – Bulb: H3 12V 55W

REF [123TA8008](#) – Bulb: H3 24V 70W

TOTAL SOURCE[®]

REF [152TA2443](#) – 48V

- Technology: incandescent
- Mounting: pedestal M8
- Wire length: 250 mm
- Nominal power: 25W
- IP65
- Bulb included

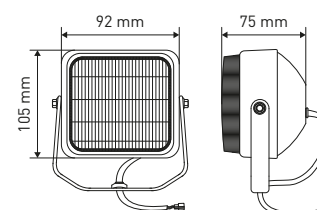

REF [144TA5559](#) – Bulb: BAY15D 48V 25W

REF [152TA2444](#) – Replacement lens

TOTAL SOURCE[®]

REF [152TA2439](#) – 48V without connector

REF [152TA2440](#) – 48V

- Technology: incandescent
- Mounting: pedestal M10
- Wire length: 250 mm
- Nominal power: 40W
- IP65
- Bulb included

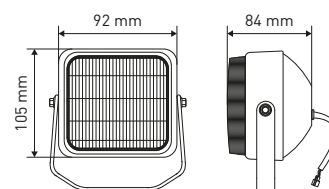

REF [100TA2273](#) – Bulb: BAY15D 48V 40W

REF [152TA2442](#) – Replacement lens

TOTAL SOURCE[®]

REF [152TA1893](#) – 12V

- Technology: halogen
- Mounting: pedestal M10
- Wire length: 225 mm
- Nominal power: 55W
- Bulb included

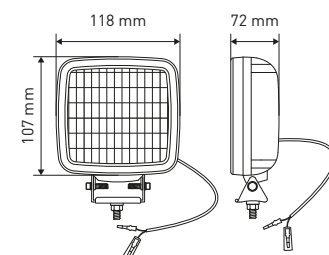

REF [161TA6105](#) – Bulb: H3 12V 55W

REF [150TA1246](#) – Replacement lens

TOTAL SOURCE[®]



WORK LIGHTS

REF 152TA2405

- Technology: incandescent
- Mounting: pendant
- Nominal power: 21W
- 12V
- IP55
- Bulb not included

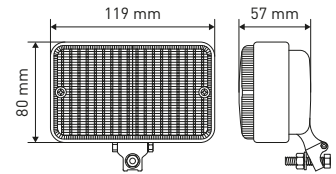

COBO
group

REF 100TA2215 – Bulb: BA15S 12V 21W

REF 149TA8594 – Replacement lens

REF 152TA1721 – 36V

REF 152TA2407 – 48V

- Technology: incandescent
- Mounting: pedestal M10
- Wire length: 200 mm
- Nominal power: 25W
- 36–48V
- Bulb included

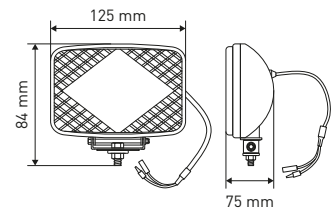

REF 122TA9125 – Bulb: BA15S 36V 25W

REF 144TA5468 – Bulb: BA15S 48V 25W

REF 152TA2408 – Replacement guard

TOTAL SOURCE[®]

REF 152TA2410 – 12V

- Technology: halogen
- Mounting: built-in
- Nominal power: 35W
- Bulb included

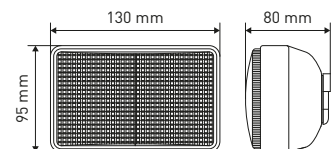

REF 142TA1228 – Bulb: PGJ13 12V 35W

TOTAL SOURCE[®]

REF 152TA2411 – 12V

- Technology: halogen
- Mounting: pedestal M10
- Wire length: 200 mm
- Nominal power: 37,5W
- Bulb included

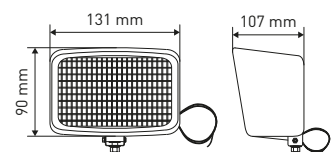

REF 144TA5518 – Bulb: PGJ13 12V 37,5W

TOTAL SOURCE[®]



WORK LIGHTS

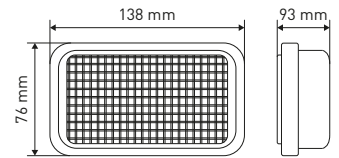

- REF 152TA2412** – 12V
- Technology: halogen
 - Mounting: built-in
 - Nominal power: 37W
 - Bulb included

REF 122TA9145 – Bulb: PGJ13 12V 37,5W

TOTAL SOURCE®

BRAND: SPEAKER

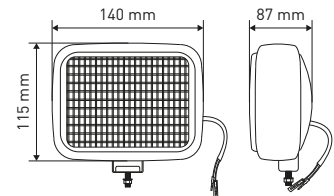

- REF 152TA2414** – 24V
- Technology: incandescent
 - Mounting: pedestal M8
 - Wire length: 150 mm
 - Nominal power: 60W
 - Bulb included

REF 106TA4884 – Bulb: BA15S 24V 60W
REF 152TA2415 – Replacement lens

TOTAL SOURCE®

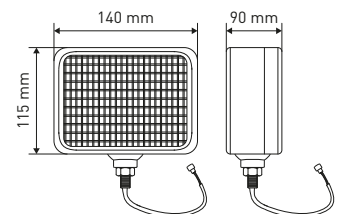

- REF 152TA2420** – 12V
REF 148TA7681 – 24V
- Technology: halogen
 - Mounting: pedestal M10
 - Wire length: 250 mm
 - Nominal power: 55W
 - IP64
 - Bulb included

REF 123TA8007 – Bulb: H3 12V 55W
REF 161TA6106 – Bulb: H3 24V 70W
REF 152TA2421 – Replacement lens

TOTAL SOURCE®

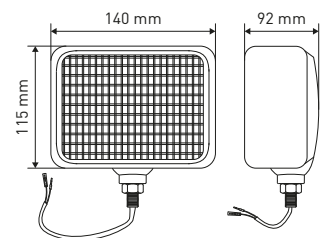

- REF 152TA2416** – 12V
REF 148TA9717 – 48V
- Technology: incandescent
 - Mounting: pedestal M12
 - Wire length: 200 mm
 - Nominal power: 35W
 - Bulb included

REF 103TA4626 – Bulb: BA15S 12V 35W
REF 103TA4632 – Bulb: BA15S 48V 45W
REF 152TA2415 – Replacement lens

TOTAL SOURCE®



WORK LIGHTS

REF 152TA2419 – 56V

- Technology: incandescent
- Mounting: pedestal M8
- Wire length: 200 mm
- Nominal power: 40W
- Bulb included

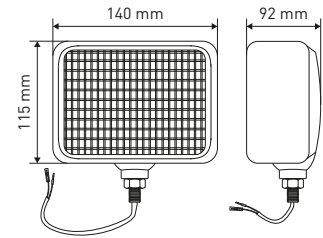

REF 103TA4637 – Bulb: BAY15D 56V 40W

TOTAL SOURCE®

REF 152TA2406 – 12V

REF 148TA7665 – 24V

REF 147TA3097 – 48V

- Technology: incandescent
- Mounting: pedestal M10
- Wire length: 300 mm
- Bulb included

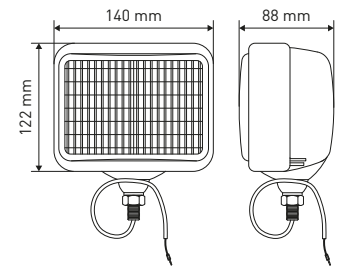

REF 100TA2215 – Bulb: BA15S 12V 21W

REF 103TA4630 – Bulb: BA15S 24V 36W

REF 103TA4634 – Bulb: BA15D 48V 35W

REF 152TA2415 – Replacement lens

TOTAL SOURCE®

REF 152TA2418 – 48V

- Technology: incandescent
- Mounting: pedestal M8
- Wire length: 200 mm
- Nominal power: 40W
- IP64
- Bulb included

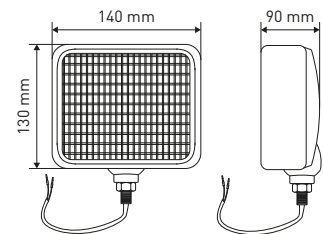

REF 103TA4636 – Bulb: BAY15D 48V 40W

TOTAL SOURCE®

REF 152TA2413 – 12V

- Technology: halogen
- Mounting: pedestal M8
- Wire length: 240 mm
- Nominal power: 37,5W
- Bulb included

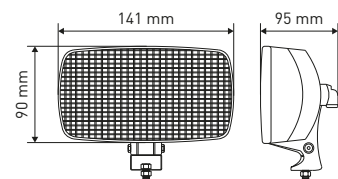

REF 122TA9145 – Bulb: PGJ 12V 37,5W

TOTAL SOURCE®



WORK LIGHTS

REF [152TA2430](#) – 12V

- Technology: halogen
- Mounting: pedestal M10
- Wire length: 260 mm
- Nominal power: 35W
- Bulb included
- Bracket not included

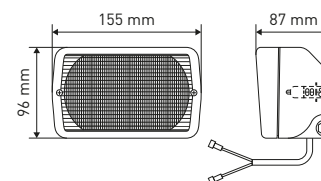

REF [161TA6105](#) – Bulb: H3 12V 35W

TOTAL SOURCE[®]

REF [152TA2431](#)

- Technology: halogen
- Mounting: pedestal M8
- 12–24–36–48V
- IP67
- Bulb not included
- Extra: vibration damper

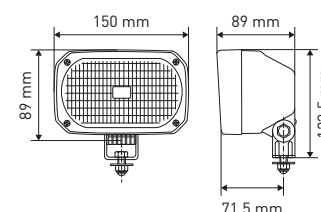

REF [161TA6105](#) – Bulb: H3 12V 55W

REF [161TA6106](#) – Bulb: H3 24V 70W

REF [142TA1218](#) – Bulb: H3 36V 45W

REF [144TA5499](#) – Bulb: H3 48V 45W

TOTAL SOURCE[®]

BRAND: NORDIC LIGHTS

REF [152TA2402](#) – 12V

- Technology: halogen
- Mounting: pedestal M8
- Wire length: 300 mm
- Nominal power: 55W
- IP67
- Bulb included

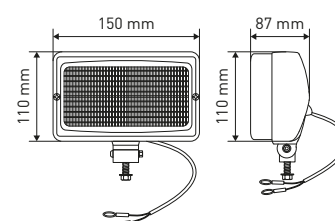

REF [123TA8007](#) – Bulb: H3 12V 55W

TOTAL SOURCE[®]

REF [152TA2432](#) – Without bulb

REF [152TA2401](#) – 12V

REF [126TA6016](#) – 24V

REF [164TA7821](#) – 36V

- Technology: halogen
- Mounting: pedestal M10
- Wire length: 200 mm
- Bulb not included

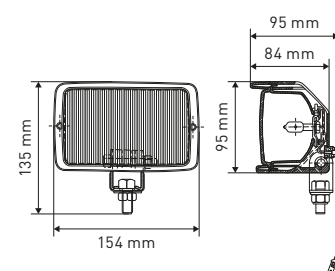

REF [161TA6105](#) – Bulb: H3 12V 55W

REF [161TA6106](#) – Bulb: H3 24V 70W

REF [142TA1218](#) – Bulb: H3 36V 45W

TOTAL SOURCE[®]



WORK LIGHTS

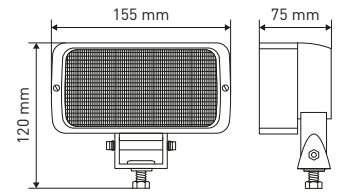

REF 152TA2433

- Technology: halogen
- Mounting: pedestal M10
- 12-24V
- IP5K4K
- Bulb not included

REF 123TA8007 – Bulb: H3 12V 55W

REF 161TA6106 – Bulb: H3 24V 70W

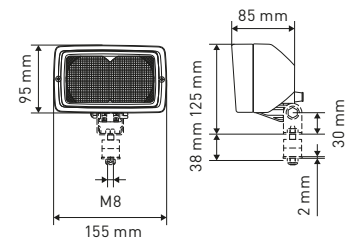

REF 152TA2435

- Technology: halogen
- Mounting: pedestal M8
- 12-24V
- IP54
- Bulb not included

REF 123TA8007 – Bulb: H3 12V 55W

REF 161TA6106 – Bulb: H3 24V 70W

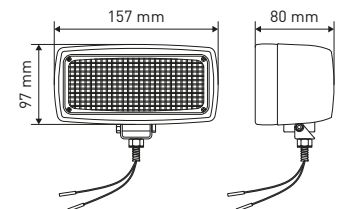

REF 152TA2403 – 12V

- Technology: halogen
- Mounting: pedestal M10
- Wire length: 150 mm
- Nominal power: 55W
- IP65
- Bulb included

REF 123TA8007 – Bulb: H3 12V 55W

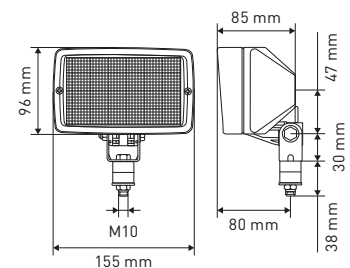

REF 152TA2436

- Technology: halogen
- Mounting: pedestal M8
- Extra: vibration damping
- 12-24V
- IP54
- Bulb not included

REF 123TA8007 – Bulb: H3 12V 55W

REF 161TA6106 – Bulb: H3 24V 70W





WORK LIGHTS

REF 152TA2437 – 12V

REF 152TA2438 – 24V

- Technology: halogen
- Mounting: pedestal M8
- Wire length: 80 mm
- Extra: iron handle
- Bulb included

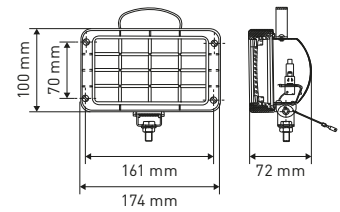

REF 123TA8007 – Bulb: H3 12V 55W

REF 161TA6106 – Bulb: H3 24V 70W

TOTAL SOURCE®

REF 152TA2404 – 24V

- Technology: sealed beam
- Mounting: pedestal M10
- Wire length: 150 mm
- Nominal power: 60W
- Sealed beam included
- Not replaceable

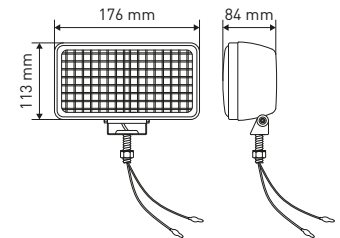

TOTAL SOURCE®



WORK LIGHTS

- REF 152TA2448** – Without bulb
REF 164TA7941 – 12V
REF 148TA8199 – 24V
- Technology: halogen
 - Mounting: bracket
 - IP65
 - Bulb not included
 - Extra: 4-point bracket included

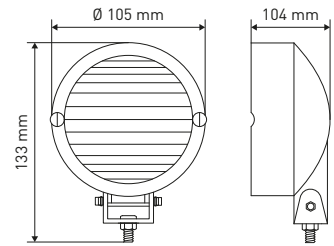

- REF 161TA6105** – Bulb: H3 12V 55W
REF 161TA6106 – Bulb: H3 24V 70W

TOTAL SOURCE[®]

- REF 152TA2446**
- Technology: halogen
 - Mounting: pedestal M8
 - Wire length: 140 mm
 - 12–24V
 - Bulb not included

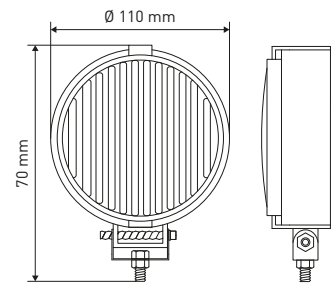

- REF 123TA8007** – Bulb: H3 12V 55W
REF 123TA8008 – Bulb: H3 24V 70W

TOTAL SOURCE[®]

- REF 152TA2447** – 12V
- Technology: halogen
 - Mounting: pedestal M8
 - Wire length: 240 mm
 - Nominal power: 55W
 - Bulb included

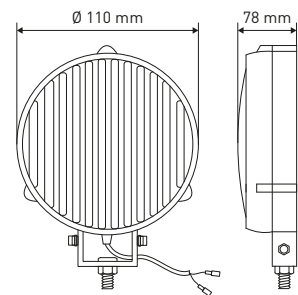

- REF 161TA6105** – Bulb: H3 12V 55W

TOTAL SOURCE[®]

- REF 152TA2450** – 12V
REF 152TA2451 – 24V
- Technology: sealed beam
 - Mounting: pedestal M8
 - Wire length: 230 mm
 - Sealed beam included

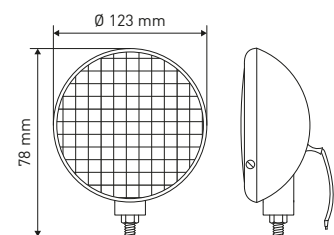

- REF 150TA2410** – Sealed beam: 12V 35W
REF 122TA7693 – Sealed beam: 24V 50W
REF 150TA6376 – Sealed beam: 24V 80W

TOTAL SOURCE[®]



WORK LIGHTS

- REF [152TA2456](#) – 12V
- REF [152TA2457](#) – 24V
- REF [152TA2458](#) – 36V
- Technology: sealed beam
- Mounting: pedestal M10
- Wire length: 360 mm
- Sealed beam included

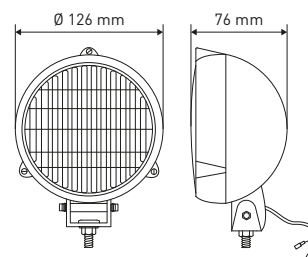

- REF [106TA1269](#) – Sealed beam: 12V 35 W
- REF [122TA7693](#) – Sealed beam: 24V 50W
- REF [131TA8892](#) – Sealed beam: 36V 60W

TOTAL SOURCE®

- REF [152TA2460](#) – 12V
- Technology: incandescent
- Mounting: pedestal M10
- Wire length: 160 mm
- Nominal power: 35W
- Bulb included

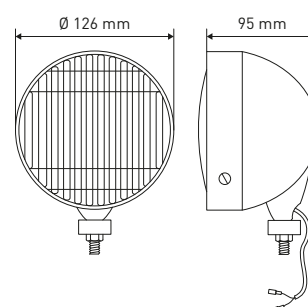

- REF [142TA1295](#) – Bulb: P15D 12V 35/35W
- REF [152TA2461](#) – Replacement lens

TOTAL SOURCE®

- REF [152TA2452](#) – 12V
- REF [152TA2453](#) – 24V
- REF [152TA2454](#) – 36V
- REF [152TA2455](#) – 48V
- Technology: halogen
- Mounting: pedestal M8
- Wire length: 150 mm
- Bulb included

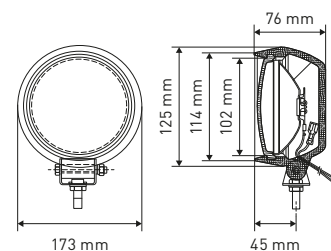

- REF [123TA8007](#) – Bulb: H3 12V 55W
- REF [123TA8008](#) – Bulb: H3 24V 70W
- REF [123TA8009](#) – Bulb: H3 36V 45W
- REF [123TA8010](#) – Bulb: H3 48V 45W

TOTAL SOURCE®

- REF [152TA2465](#) – 12V
- Technology: sealed beam
- Mounting: pedestal M10
- Wire length: 250 mm
- Nominal power: 35W
- Sealed beam not replaceable

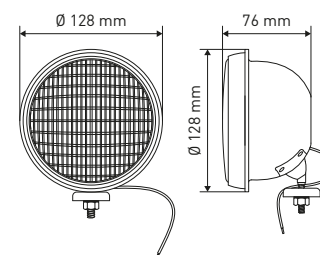

- REF [150TA2410](#) – Sealed beam: 12V 35 W
- REF [152TA2493](#) – Protection support

TOTAL SOURCE®



WORK LIGHTS

- REF 152TA2462** – 12V
REF 152TA2463 – 24V
- Technology: incandescent
 - Mounting: pedestal M10
 - Wire length: 200 mm
 - Nominal power: 48W

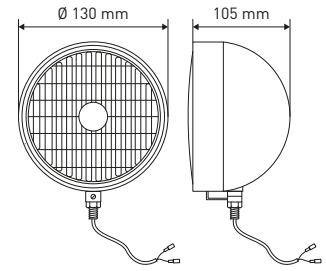

- REF 131TA4781** – Bulb: BA15D 12V 36W
REF 131TA4783 – Bulb: BA15D 24V 36W

TOTAL SOURCE®

- REF 152TA2464** – 12V
- Technology: incandescent
 - Mounting: pedestal M12
 - Wire length: 1400 mm
 - Nominal power: 35W
 - Bulb included

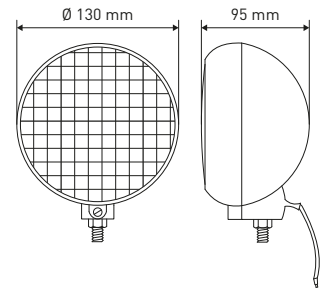

- REF 106TA1267** – Bulb: BA20D 12V 35W
REF 149TA7846 – Replacement lens and mirror

TOTAL SOURCE®

- REF 152TA2466**
- Technology: incandescent
 - Mounting: central bolt
 - 12–24V
 - Bulb not included

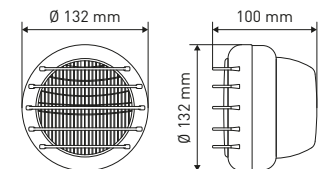

- REF 123TA7997** – Bulb: BA20D 12V 35W
REF 122TA9135 – Bulb: BA20D 24V 25W



- REF 152TA2468** – 12V
- Technology: halogen
 - Mounting: pedestal M12
 - Wire length: 300 mm
 - Nominal power: 55W
 - Bulb included

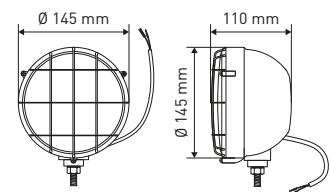

- REF 123TA8007** – Bulb: H3 12V 55W
REF 152TA2469 – Optical unit
REF 152TA2470 – Protection guard
REF 152TA2492 – Protection support

TOTAL SOURCE®



WORK LIGHTS

REF [152TA2472](#)

- Technology: halogen
- Mounting: pedestal M12
- Nominal power: 45W
- 12–24V
- Bulb not included

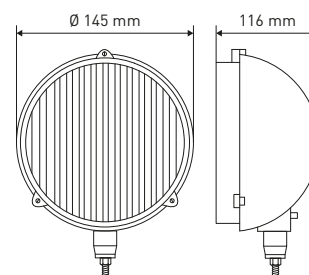

REF [106TA4826](#) – Bulb: R2 12V 40/45W

REF [106TA4827](#) – Bulb: R2 24V 50/50W

REF [152TA2473](#) – Optical unit



REF [152TA2474](#)

- Technology: halogen
- Mounting: 2-point bracket
- 12–24V
- Bulb not included
- Extra: handle and on/off switch

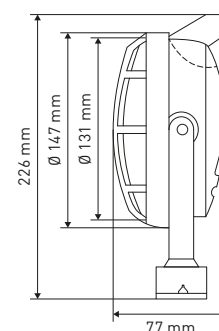

REF [123TA8007](#) – Bulb: H3 12V 55W

REF [123TA8008](#) – Bulb: H3 24V 70W

TOTAL SOURCE[®]

REF [152TA2485](#) – 12V

REF [152TA2486](#) – 24V

- Technology: incandescent
- Mounting: 4-point bracket
- Wire length: 100 mm
- Bulb included
- Extra: on/off switch

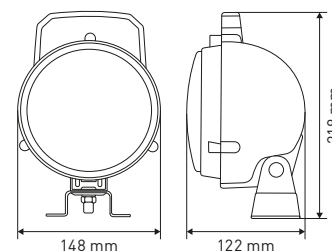

REF [161TA6096](#) – Bulb: BA20S 12V 35W

REF [141TA9895](#) – Bulb: BA20S 24V 35W

REF [152TA2494](#) – Optical unit

TOTAL SOURCE[®]

REF [152TA2476](#) – Without hand grip

REF [152TA2477](#) – With hand grip

- Technology: halogen
- Mounting: pedestal M10
- 12–24V
- IP5K4K
- Bulb not included

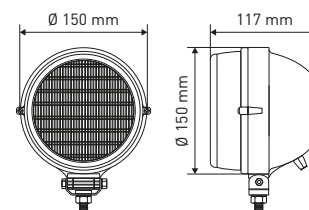

REF [123TA8007](#) – Bulb: H3 12V 55W

REF [123TA8008](#) – Bulb: H3 24V 70W





WORK LIGHTS

REF 152TA2480

- Technology: halogen
- Mounting: pedestal M12
- 12-24V
- IP54
- Bulb not included

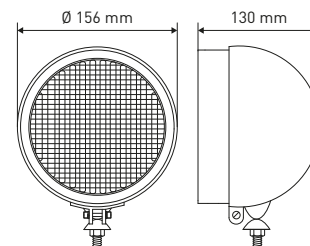

REF 123TA8007 – Bulb: H3 12V 55W

REF 123TA8008 – Bulb: H3 24V 70W

REF 152TA2481 – Optical unit

TOTAL SOURCE®

REF 152TA2483 – 12V

REF 152TA2484 – 24V

- Technology: halogen
- Mounting: 2 point bracket
- Extra: protection guard and on/off switch
- Bulb included

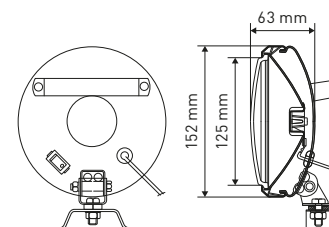

REF 123TA8007 – Bulb: H3 12V 55W

REF 123TA8008 – Bulb: H3 24V 70W

TOTAL SOURCE®

REF 152TA1719 – 12V LH

REF 152TA1718 – 12V RH

- Technology: halogen
- Mounting: built-in
- Used on Bobcat
- Bulb included

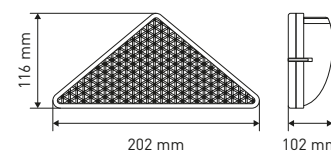

REF 122TA9146 – Bulb: PGJ13 12V 50W

TOTAL SOURCE®



PORTABLE LIGHTS



NICE TO KNOW – PORTABLE LIGHTS



The lights in this chapter (torches, signalling lights ...) are useful tools suitable for use during different situations. These are mobile lights that can easily be moved and deployed.

Find the correct light for any situation:

- **torches** to always have at hand
- **worklights** and **head lamps** to allow you to work hands-free
- **signalling lights** to indicate works or demarcate an area
- **searchlights** to easily track something



PENLIGHT

REF 144TA8716

- 6+1 SMD/LED work light with clip, portable and convenient
- 6 pcs super bright SMD (3528) as task light, 1 super bright LED on the top as torch
- Unit size: 17 cm length
- With magnet on the clip

Application:

Road, car repair, factory, work place, camping, hiking, boating, home etc



REF 145TA8828

Box of 12 penlights

REF 144TA5953 – Replacement batteries

LED HANDHELD TORCH LIGHTS

REF 163TA8540

- Light output: 250 lumen
- Housing: aluminium
- 3 lighting modes: turbo/general/strobe
- Waterproof up to 100 m (300 ft)
- 10° spot beam and 25° flood beam
- Total length: 130 mm
- IP68



REF 144TA5953 – Replacement batteries

REF 139TA3253

- Light output: more than 210 lumen
- Housing: aluminium
- High powered LED 5W
- Rechargeable lithium-ion battery with 23VAC EU charger
- Waterproof
- 15° lens
- Total length: 150 mm
- 3 lighting modes: turbo/general/strobe



REF 164TA8075

- Light output: 810 lumen
- 10W powered LED
- 3 mode of light: power max, ECO, flashing
- Adaptor: AC 110 – 220V – 50/60 Hz
- Rechargeable battery: 4V 9AH
- Autonomy max: 7 h/13 h





LED SEARCH LIGHT

REF 143TA7112

New Technology – searchlight with innovative optical design (Magic Lens) & high intensity LED light source array

- With 4 high powered 10W CREE LEDs
- 14,4V 5,000 mAh Li-ion battery pack – with charging & over discharging protection
- With flood lens + 400 m scope
- 4 Modes power output – 100%, 50%, 25% & flash
- Shock-resistant nylon housing
- Heat-resistant
- Carrying case with accessories: battery, AC-charger, strap, flood lens
- Dimensions (L x W x H): 268 x 114 x 147 mm
- IP55



LED HANDHELD WORK LIGHTS

REF 139TA3256

- 60 LED handheld work lamp
- Working time: up to 4 hours on a full charge
- With charge indicator & universal AC-charger
- With swivel hooks and charge base
- Total length: 390 mm



REF 139TA3257

- 30 LED handheld work lamp
- Working time: up to 4 hours on a full charge
- With charge indicator & universal AC-charger
- With rubber surface cover
- Total length: 285 mm





LED WORK LAMP SET

REF [139TA3793](#)

Contents:

- REF 139TA3256: 60 LED handheld work lamp + charger
- REF 139TA3257: 30 LED handheld work lamp + charger
- REF 139TA3258: head light



RECHARGEABLE LED WORKLIGHT

REF [164TA9699](#)

- Technology: LED
- Nominal power: 15W
- Operating light output (100%): 1080 lumen
- LED: 5 pieces
- Housing: aluminium
- Lens: polycarbonate
- Autonomy: 3-4 h (100% brightness)
- IP67
- 240V EU charger & 12V car plug charger included



MAGNETIC MINI WORKLIGHT

REF [164TA1549](#)

- Technology: LED
- Length: 155 mm
- Wire length: 100 mm
- 100-240V
- IP20
- Rechargeable via USB
- USB-cable included



LED TORCH - WARNING COMBINATION LIGHT

REF [139TA3255](#)

- LED nominal power: 3W
- Light output: up to 250 lumen
- Waterproof
- Holder with magnetic base and removable warning signal cover
- Super compact: total length 120 mm without/190 mm with emergency cover



REF [144TA5953](#) – Replacement batteries



WORKLAMPS

REF [107TA7550](#)

- Dimensions: 495 x 110 x 285 mm
- Wire length: 5 m rubber cable
- Shock-resistant
- 230V 50 Hz
- 72W (2 x 36W TC-L) = 300W light output
- IP54 splashproof
- Diffuser and casing made of impact-resistant material
- Multipositional arm
- 2 x 230V safety sockets on the back



REF [107TA7546](#)

- TL worklamp
- 230V/8W
- IP20
- 5 m cable



SAFETY INSPECTION

REF [107TA7549](#)

- 10 m cable
- Insulated handgrip: oil-, acid- and solvent-resistant
- Reflecting cage made of zinc-coated steel
- Rotating hanging-hook
- IP20
- Bulb not included (bulb: REF 140TA8363 – E27 220V 60W max)



LED STROBE LIGHT

REF [107TA8121](#)

- Technology: LED
- Ø 187 mm
- Length: 192 mm
- Height: 348 mm
- 6V
- Battery not included
- Bulb included

REF [151TA3827](#) – Battery

REF [151TA3828](#) – Key





ROAD MARKER

REF 163TA8810

- Technology: LED
- Mounting: portable
- Length: 500 mm
- Width: 500 mm
- Height: 500 mm
- Wire length: 3000 mm
- 12-24V
- Battery not included
- Sealed bulb



PORTABLE FLOOD LIGHTS

REF 152TA2490

- Technology: LED
- Mounting: portable
- Length: 75 mm
- Width: 95 mm
- Height: 100 mm
- 12-24V
- UK & European charger and car plug included (REF 164TA9696)
- Theoretical output: 900 lumen
- Nominal power: 10W
- IP65



REF 152TA2489

- Technology: LED
- Mounting: portable
- Length: 325 mm
- Width: 190 mm
- Height: 370 mm
- 12-24V
- UK & European charger and car plug included (REF 164TA9696)
- Theoretical output: 1800 lumen
- Nominal power: 20W
- IP65



MOBILE AKKU CHIP LED LIGHT

REF 152TA2487

- Technology: LED
- For installation indoors and outdoors
- Nominal power: 10W
- Luminous flux: 650 lumen
- IP54
- Rechargeable battery: 11,1V/2200 mAh





MOBILE CHIP LED LIGHT

REF 152TA2488

- Technology: LED
- For installation indoors and outdoors
- Stable steel tube frame with ergonomically preformed handles
- Nominal power: 50W
- Light output: 3500 lumen
- IP65
- Input voltage: 230VAC EU-plugin



FLOOD LIGHT

REF 164TA1550

- Technology: halogen
- For installation indoors and outdoors
- Mounted on stable ground tripod
- Nominal power: 400W
- Dimmer included
- Input voltage: 230VAC EU-plugin





PREMIUM BULBS



NICE TO KNOW – PREMIUM BULBS



Philips car lighting, the ultimate choice for the road

Light can help us feel safe when on the road. Bright, clear headlights improve visibility without blinding other drivers with glare. Precise in-car lighting adds comfort without distracting the person who's driving. For nearly a century, Philips Automotive has been dedicated to providing the best in-class lighting solutions in the Aftermarket and Original Equipment Manufacturer and Supplier (OEM, OES) markets. One out of every three cars around the world comes equipped with Philips bulbs.

Philips car lighting, the ultimate choice for the road

- Innovator for car lighting since 1914
- Inventor of the xenon HID lighting
- The preferred choice of leading car manufacturers

Philips is the only supplier who offers all its bulbs in quartz glass (instead of hardened glass).

Advantages:

- Higher pressure-resistance, better light distribution
- Higher resistance against thermal shocks
- UV-protection. Prevents optics from 'turning yellow'



BA9S

U1 (V)	P1 (W)	REF
12	2	163TA8251
12	4	145TA2682
24	2	163TA8252
24	4	160TA1133

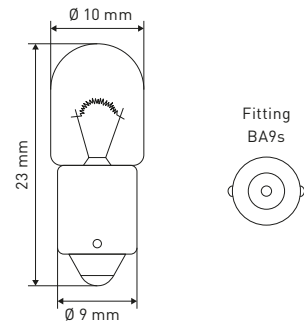

PHILIPS

BA15S TUBULAR

U1 (V)	P1 (W)	REF
12	5	145TA2680
12	10	145TA2676
24	5	160TA1131
24	10	160TA1130

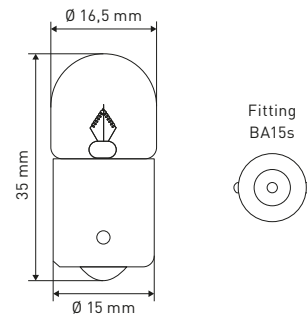

PHILIPS

BA15S

U1 (V)	P1 (W)	REF
12	21	145TA2673
24	21	145TA2674

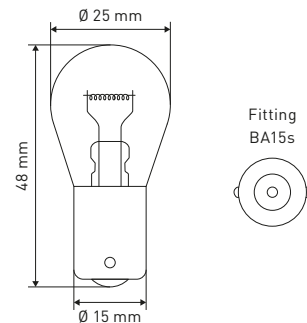

PHILIPS

BA15S SPHERICAL

U1 (V)	P1 (W)	REF
12	18	163TA8253

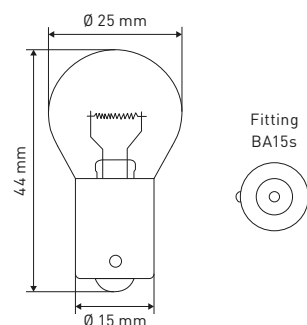

PHILIPS



BAY15D

U1 (V)	P1 (W)	P2 (W)	REF
12	21	5	145TA2099
24	21	5	145TA2686

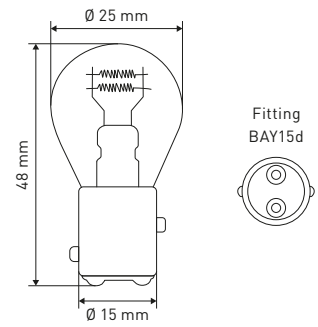

PHILIPS

BAU15S

U1 (V)	P1 (W)	REF
12	21	160TA1124

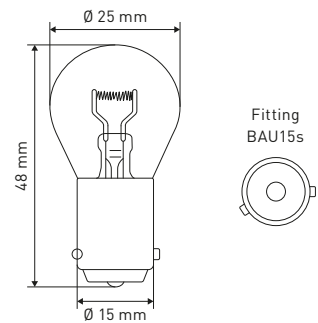

PHILIPS

H1

U1 (V)	P1 (W)	REF
12	55	145TA2684
24	70	163TA8254

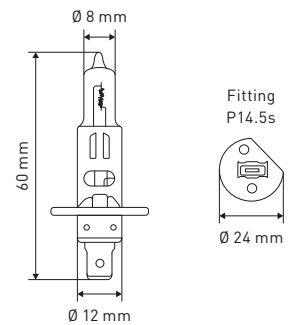

PHILIPS

H3

U1 (V)	P1 (W)	REF
12	55	145TA2675
24	70	145TA2677

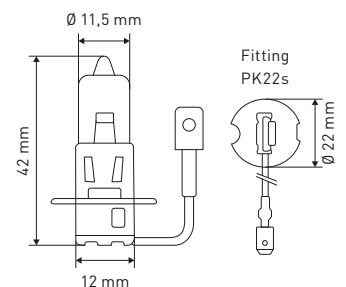

PHILIPS



H4

U1 (V)	P1 (W)	P2 (W)	REF
12	60	55	160TA1121
24	75	70	160TA1129

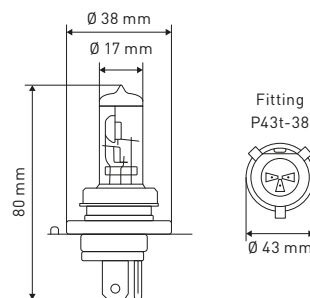

PHILIPS

H7

U1 (V)	P1 (W)	REF
12	55	145TA2681
24	70	160TA1135

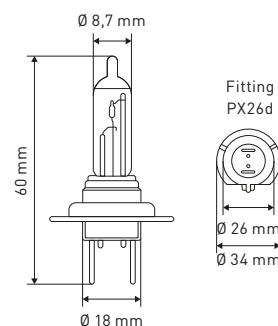

PHILIPS

R2

U1 (V)	P1 (W)	P2 (W)	REF
12	45	40	145TA2685
24	55	50	163TA8255

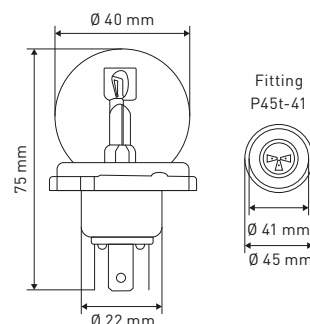

PHILIPS

SV8.5-8

U1 (V)	P1 (W)	REF
12	5	160TA1122
12	10	163TA8256
24	5	160TA1132
24	10	163TA8257

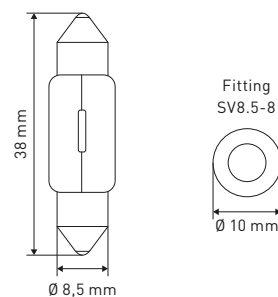

PHILIPS



SV8.5-8

U1 (V)	P1 (W)	REF
12	5	163TA8258
12	10	145TA2683
24	5	163TA8259
24	10	163TA8260

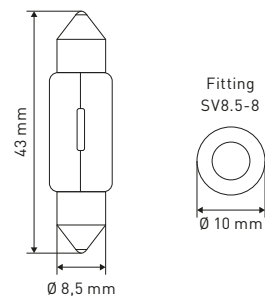

PHILIPS

U1 (V)	P1 (W)	REF
24	18	145TA2678

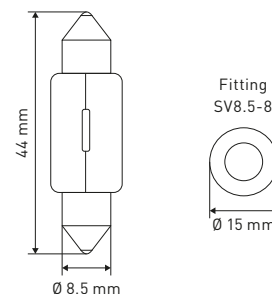

PHILIPS

W2.1X9.5D

U1 (V)	P1 (W)	REF
12	3	163TA8263
12	5	160TA1125
24	3	163TA8262
24	5	161TA5953

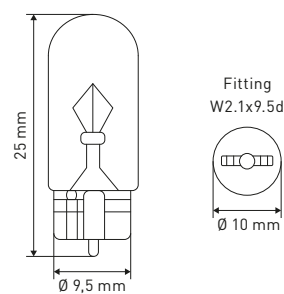

PHILIPS

W2X4.6D

U1 (V)	P1 (W)	REF
12	1,2	145TA2679
12	2	161TA5954
24	1,2	163TA8264
24	2	163TA8265

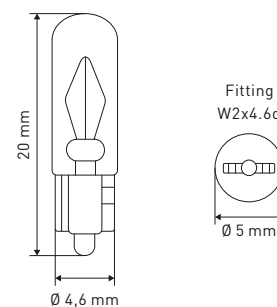

PHILIPS



P13W

U1 (V)	P1 (W)	REF
12	13	161TA5900

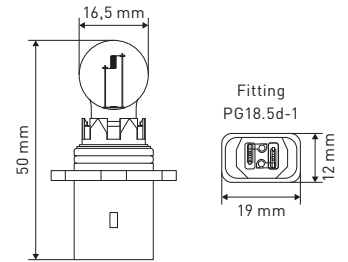

PHILIPS

PS19W

U1 (V)	P1 (W)	REF
12	19	161TA5901

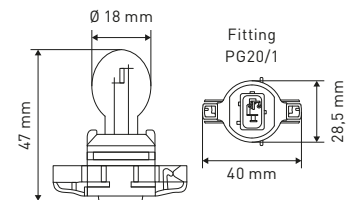

PHILIPS

PSY19W

U1 (V)	P1 (W)	Remark	REF
12	19	Orange	161TA5902

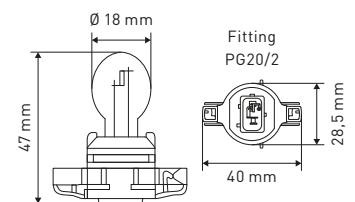

PHILIPS

PS24W

U1 (V)	P1 (W)	REF
12	24	142TA1251

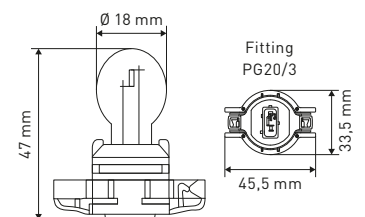

PHILIPS



PSY24W

U1 (V)	P1 (W)	Remark	REF
12	24	Orange	161TA5903

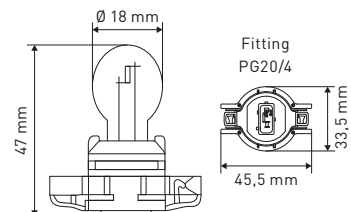

PHILIPS

D1S (XENON)

U1 (V)	P1 (W)	REF
85	35	147TA4297

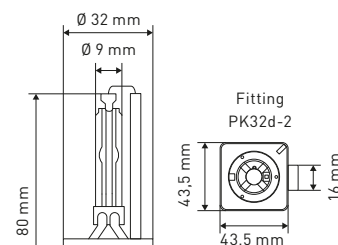
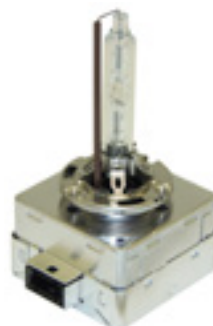

PHILIPS

D1R (XENON)

U1 (V)	P1 (W)	REF
85	35	147TA4299

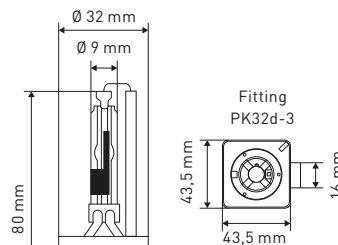
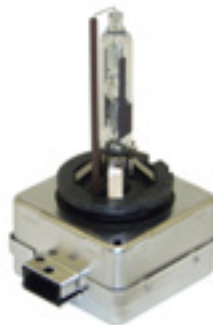

PHILIPS

D2S (XENON)

U1 (V)	P1 (W)	REF
85	35	147TA4300

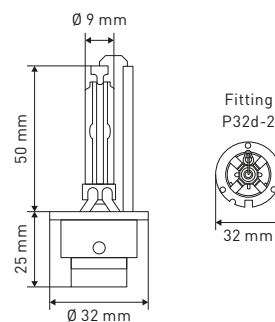

PHILIPS



D2R (XENON)

U1 (V)	P1 (W)	REF
85	35	147TA4302

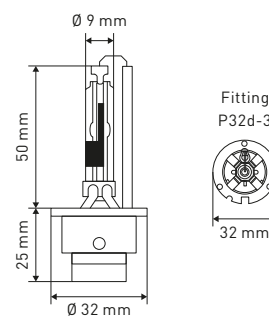

Fitting
P32d-3



PHILIPS



NOTES

A series of horizontal dotted lines for writing notes.



FLASHTUBES



NICE TO KNOW – FLASHTUBES



A flashtube works via a short discharge through a special gas discharge bulb filled with xenon gas. The required energy is first stored in a capacitor. A small converter and transformer deliver the correct voltage, as the voltage of the capacitor is in principle not high enough to ignite the tube. That is why an extra electrode is added to generate a power surge that allows the ignition.



Picture 1: The power surge ionises the gas.



Picture 2: The capacitor lets the current charge flow through the tube which causes a reaction with the xenon gas.



Picture 3: As the resistance drops, the tube fills up with xenon, which is now in a plasma state.



Picture 4: The full current now flows through the tube and radiates light.



FLASHTUBES

Connections	REF
3	160TA1088

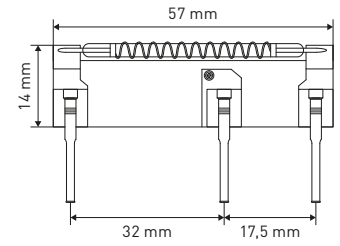

Connections	REF
3	142TA1279

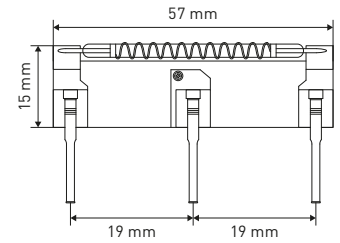

Connections	REF
3	151TA3674

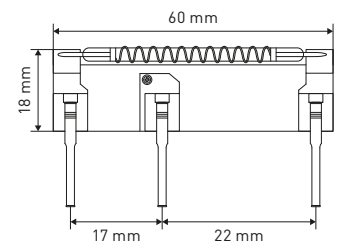

Connections	REF
3	106TA9126

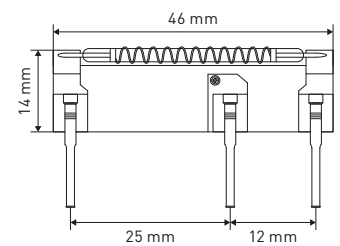



FLASHTUBES

Connections	REF
3	126TA6121

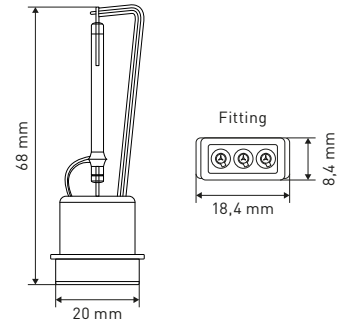

Connections	REF
3	151TA3766

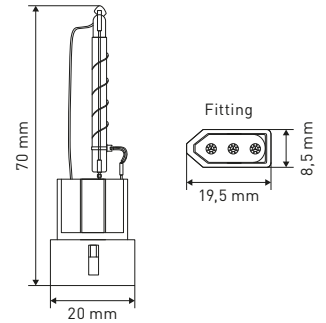

Connections	REF
3	142TA1342

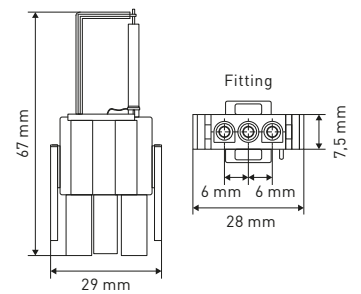

Connections	REF
3	134TA2345

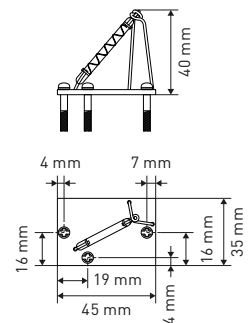
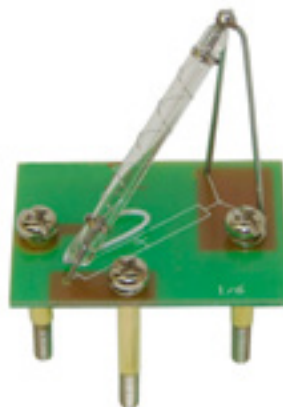



FLASHTUBES

Connections	REF
3	116TA5655

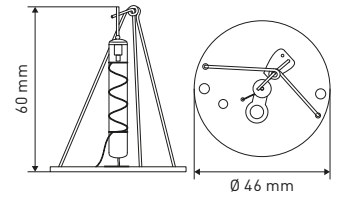

Connections	REF
3	151TA3707

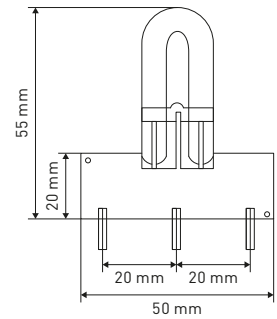
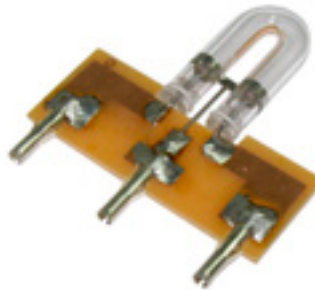

Connections	REF
3	142TA1340

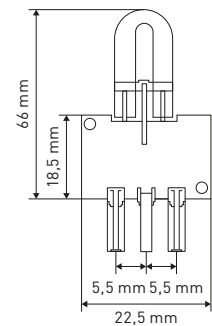

Connections	REF
3	142TA1144

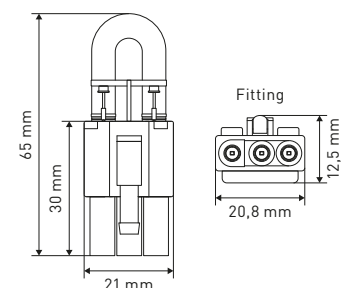



FLASHTUBES

Connections	REF
3	151TA3713

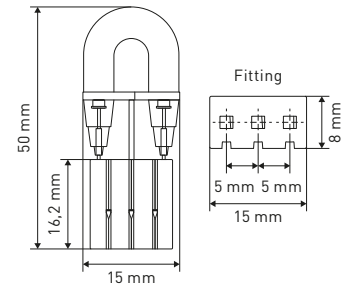

Connections	REF
3	144TA5708

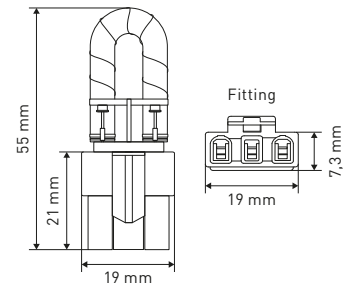



INCANDESCENT BULBS



NICE TO KNOW – INCANDESCENT BULBS



To this day, incandescent bulbs are the second most used bulbs in the world after fluorescent bulbs.

Advantages:

- Great to illuminate small areas
- Cheap to produce
- Can easily be adjusted (e.g.: dimmer)
- No chemical materials required

Disadvantages:

- Not energy-efficient:
 - 90% of the energy is lost in heat while only 10% of the energy is converted to light
 - Not ideal for larger spaces

Functioning:

When a current flows through a filament in a low-oxygen environment, a light source is created. As soon as the light bulb is connected to a suitable tension, this piece of metal heats up so strongly that it emits visible light.

A glass bulb, in which very little to no oxygen is present, protects the filament from burning. If the filament comes in contact with oxygen from the ambient air due to damage to the bulb, it will burn within one second after the light is switched on.



MIDGET GROOVED T1 3/4

U1 (V)	P1 (W)	REF
14	1,12	103TA4563
28	1,12	131TA4743

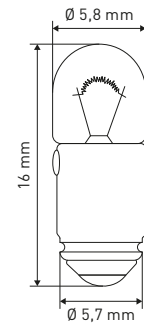

Fitting
T1 3/4

MIDGET FLANGED T1 3/4

U1 (V)	P1 (W)	REF
12	1,2	152TA2514
14	1,12	141TA9705
28	1,12	141TA9706

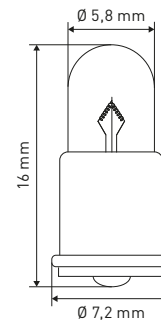

Fitting
T1 3/4

BA7S

U1 (V)	P1 (W)	REF
6	0,6	106TA4839
12	2	123TA8015
12	4	152TA2515
24	2	131TA4741
24	3	103TA4560
36	1,2	141TA9701
36	1,8	131TA4742
48	2	119TA8911
60	1,2	103TA4561

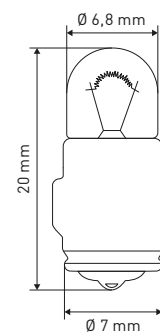

Fitting
BA7s



BA9S

U1 (V)	P1 (W)	REF
6	1,5	152TA2516
6	2	103TA4573
12	2	103TA4574
12	3	103TA4571
12	5	115TA4601
24	2	103TA4576
24	3	131TA4748
24	4	103TA4577
30	3	131TA4750
36	2,5	106TA4898
48	2	123TA7978
48	2,5	123TA7979
80	1,6	119TA8914

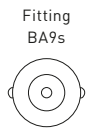
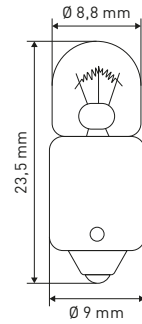

U1 (V)	P1 (W)	REF
12	4	103TA4572
24	4	106TA4840
48	2	106TA4844
80	2	131TA4747
130	2,6	106TA4841

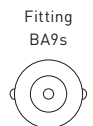
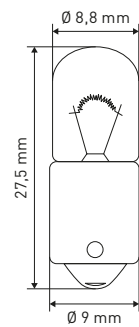



BA9S

U1 (V)	P1 (W)	REF
12	2	131TA4758
12	4	122TA9116
12	5	122TA9117
24	2	122TA9118
24	3	103TA4580
24	5	106TA4849
28	5	159TA9759
30	2	131TA4760
36	1,8	131TA4761
48	2	131TA4762
48	2,4	141TA9755
48	3	131TA4763
48	4	119TA8915
48	5	123TA7981
60	2	131TA4755
80	3	141TA9758
130	2,6	131TA4756
240	2,4	131TA4757

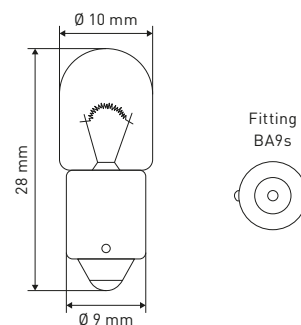

U1 (V)	P1 (W)	REF
6	6	141TA9739
12	1,5	106TA4845
12	2	131TA4754
12	3	106TA4846
12	3,4	103TA4578
12	5	103TA4579
24	2,8	141TA9740
24	5	106TA4848
30	2	131TA4752
30	3	131TA4753

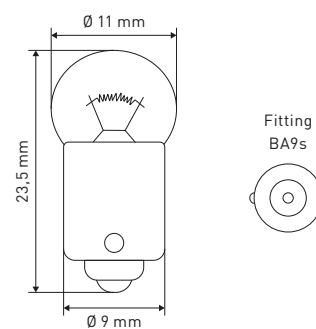



BA9S

U1 (V)	P1 (W)	Remark	REF
6	5		103TA4564
12	3		103TA4565
12	3	Red	141TA9710
12	3,4		122TA9114
12	5		141TA9717
12	6		103TA4566
12	7,5		122TA9115
24	4		103TA4568
24	5		103TA4569
48	2,5		119TA8912
48	3,5		131TA4744
48	5		131TA4745

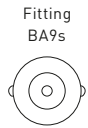
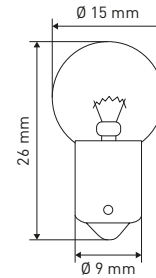

BA15S SPHERICAL

U1 (V)	P1 (W)	Remark	REF
6	5		103TA4584
12	3		122TA9119
12	5		123TA7982
12	10		123TA7983
12	15		106TA4853
12	20		159TA9760
24	5		103TA4587
24	5	Heavy-duty	141TA9768
24	10		123TA7984
24	15		131TA4764
36	10		106TA4856
48	8		103TA4589
48	10		123TA7985

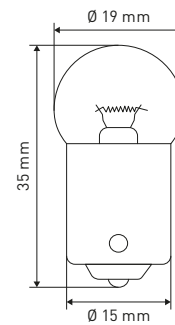

BA15S TUBULAR

U1 (V)	P1 (W)	REF
6	5	115TA4603
12	5	115TA4602
12	10	103TA4596
24	5	103TA4597
24	10	106TA4860

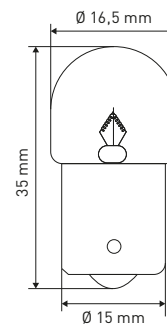



BA15D SPHERICAL

U1 (V)	P1 (W)	REF
6	10	119TA8916
12	5	103TA4593
12	10	123TA8034
12	15	131TA4765
24	5	103TA4595
24	10	106TA4857
24	15	131TA4766
48	8	106TA4859
48	10	119TA8917

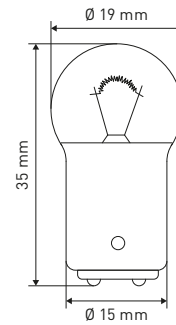

Fitting
BA15d

BA15D TUBULAR

U1 (V)	P1 (W)	REF
6	5	159TA9761
12	5	159TA9762
12	10	159TA9763
24	5	159TA9764

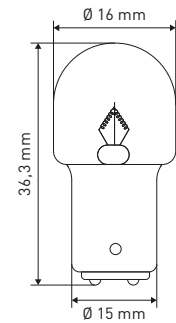

Fitting
BA15d

BAY15D SPHERICAL

U1 (V)	P1 (W)	REF
36	8	122TA9120
48	8	131TA4767
48	10	123TA7986
60	10	103TA4600

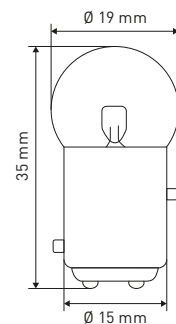

Fitting
BAY15d



BA15S

U1 (V)	P1 (W)	Remark	REF
6	21		119TA8920
12	15		131TA4770
12	18		106TA4861
12	21		100TA2215
12	21	Orange	122TA9122
12	25		103TA4602
12	27		163TA8241
24	15		142TA3650
24	18		131TA4772
24	21	Orange	103TA4603
24	21		142TA3656
24	25		103TA4604
24	35		106TA4863
36	10		122TA9124
36	25		122TA9125
48	10		119TA8918
48	15		122TA9126
48	23		141TA9805
48	25		123TA7987
48	35		131TA4768
48	45		131TA4769
56	25		141TA9809

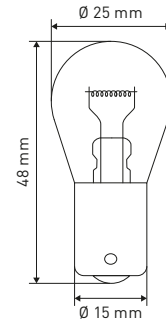

Fitting
BA15s

U1 (V)	P1 (W)	REF
6	15	103TA4605

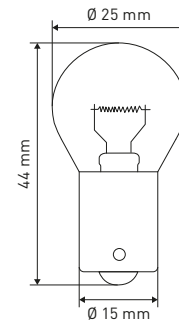

Fitting
BA15s



BA15S

U1 (V)	P1 (W)	REF
12	35	103TA4626
12	45	123TA7993
24	35	141TA9858
24	40	103TA4631
24	45	106TA4883
24	60	106TA4884
48	45	103TA4632
80	25	103TA4633

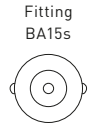
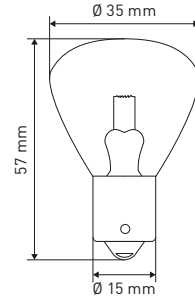

U1 (V)	P1 (W)	REF
12	36	141TA9854
24	36	141TA9856
24	48	141TA9855
24	60	123TA7994

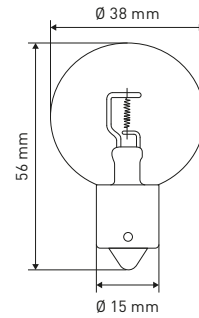

BA15D

U1 (V)	P1 (W)	REF
6	21	159TA9949
12	10	103TA4610
12	15	131TA4775
12	21	103TA4611
12	25	115TA4605
24	21	103TA4613
36	10	142TA3651
36	25	141TA9825
40	15	115TA4604
48	10	119TA8919
48	25	103TA4614
48	35	131TA4774

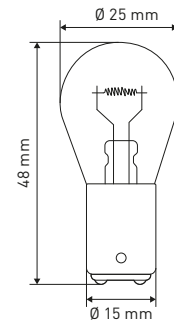



BA15D

U1 (V)	P1 (W)	P2 (W)	REF
6	10	10	159TA9950
6	35	35	103TA4619

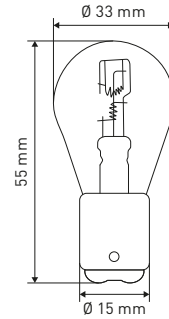

U1 (V)	P1 (W)	P2 (W)	REF
12	21	5	141TA9822
24	21	2	142TA1225

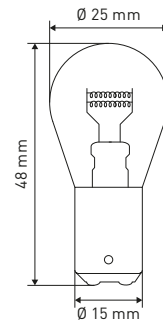

U1 (V)	P1 (W)	REF
24	5	122TA9130
48	5	131TA4779

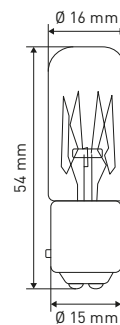



BA15D

U1 (V)	P1 (W)	REF
24	35	131TA4783
48	35	103TA4634

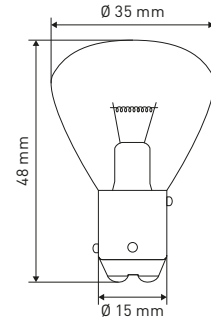

U1 (V)	P1 (W)	REF
12	36	141TA9874
24	36	141TA9875
24	48	141TA9877

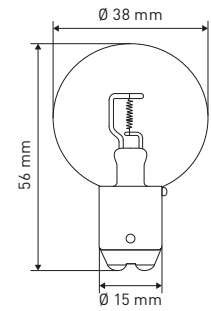

U1 (V)	P1 (W)	Remark	REF
24	40	White	131TA4780
48	40	White	106TA4902

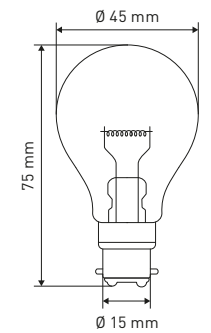



BAY15D

U1 (V)	P1 (W)	REF
24	25	106TA4879
36	25	106TA4881
48	10	119TA8924
48	25	123TA7992
48	40	115TA4606
56	25	106TA4882

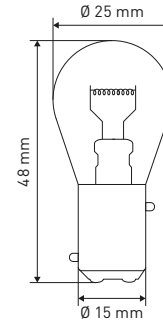

U1 (V)	P1 (W)	P2 (W)	Remark	REF
6	21	5		163TA8851
12	18	5		141TA9840
12	21	5		123TA7988
12	21	5	Heavy-duty	142TA3653
12	23	8		106TA4874
24	21	5		123TA7989
24	24	6		159TA9956
24	25	10		103TA4623
36	25	10		106TA4876
48	25	10		123TA7990
60	25	10		123TA7991
80	10	5		119TA8923

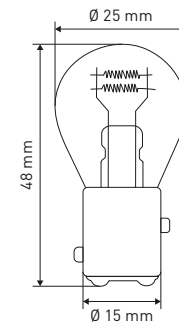

U1 (V)	P1 (W)	REF
12	40	163TA8852
24	40	119TA8926
36	40	111TA2799
48	40	103TA4636
56	40	103TA4637
60	40	141TA9866

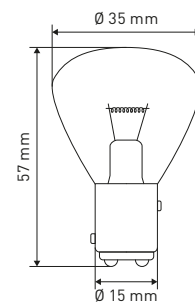



BAY15D

U1 (V)	P1 (W)	P2 (W)	REF
12	40	30	106TA4885
24	60	60	103TA4635

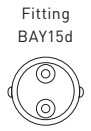
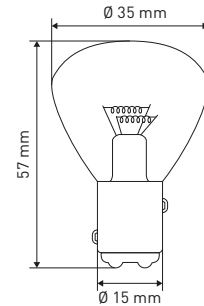

BAU15S

U1 (V)	P1 (W)	Remark	REF
12	21	Orange	140TA8980
24	21	Orange	140TA8979

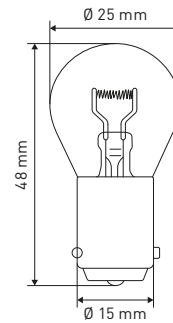

BAZ15D

U1 (V)	P1 (W)	P2 (W)	REF
12	21	4	103TA4624
24	21	4	141TA9849

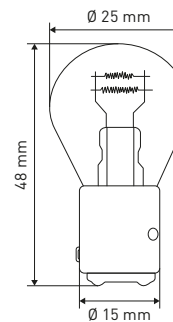



BA20S

U1 (V)	P1 (W)	REF
6	35	103TA4657
6	45	103TA4658
12	35	123TA7998
12	45	103TA4661
12	50	103TA4660
24	35	123TA7999
24	45	103TA4663
24	50	131TA4789
36	35	103TA4664
48	25	131TA4790
48	35	123TA8000
80	10	131TA4787
80	35	123TA8001

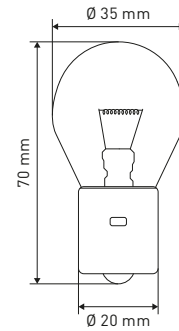

Fitting
BA20s

BA20D

U1 (V)	P1 (W)	P2 (W)	REF
6	15	15	122TA9132
6	25	25	122TA9133
6	35	35	122TA9134
6	45	40	103TA4649
12	35	35	123TA7997
12	45	40	103TA4652
24	35	35	131TA4786
24	45	40	103TA4653

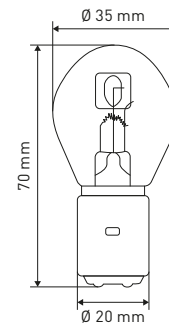

Fitting
BA20d

U1 (V)	P1 (W)	REF
24	25	122TA9135
48	25	131TA4793
48	35	131TA4794
80	25	103TA4669
80	35	131TA4792

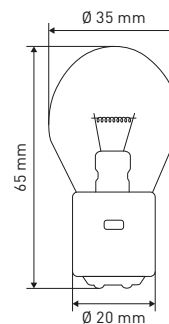

Fitting
BA20d



BA20D

U1 (V)	P1 (W)	REF
80	10	106TA4890

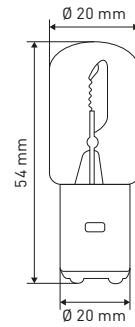

BA21S

U1 (V)	P1 (W)	REF
12	45	106TA4894

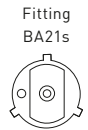
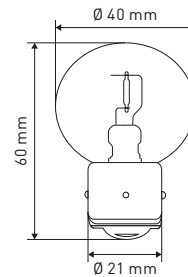

BA21D

U1 (V)	P1 (W)	P2 (W)	REF
12	45	40	141TA9915

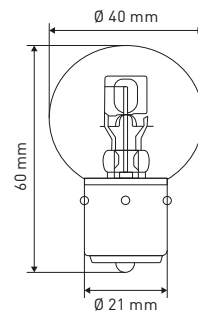



P15S

U1 (V)	P1 (W)	REF
12	35	103TA4638
24	40	106TA4899

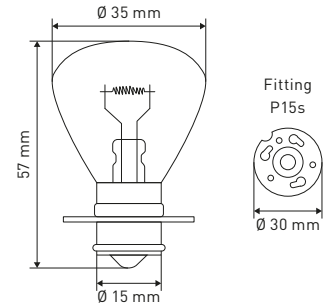

P15D

U1 (V)	P1 (W)	REF
12	45	103TA4643
24	35	103TA4644
36	30	122TA9131
48	25	123TA7995
48	45	123TA7996
48	50	106TA4900

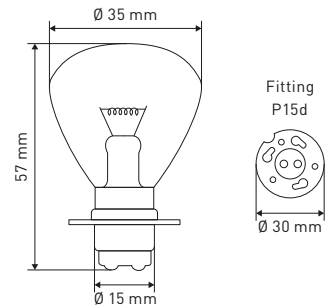

U1 (V)	P1 (W)	P2 (W)	REF
6	35	35	103TA4640
12	35	35	142TA1295
12	45	45	159TA9957
24	35	35	131TA4785
24	40	30	106TA4886
24	62	62	106TA4887

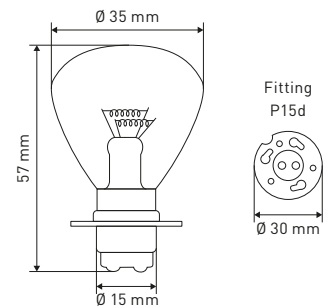



P15D-3

U1 (V)	P1 (W)	P2 (W)	REF
12	35	35	119TA8927

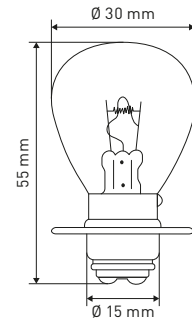

P36S

U1 (V)	P1 (W)	REF
12	48	106TA4891

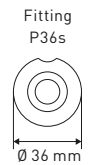
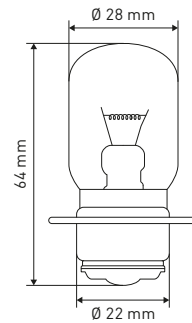

P36D

U1 (V)	P1 (W)	REF
12	38	106TA4893
24	44	122TA9137

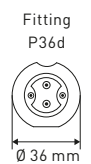
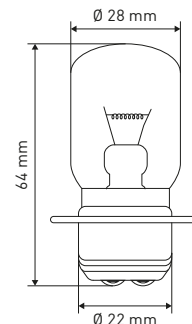



P36D

U1 (V)	P1 (W)	P2 (W)	REF
12	50	40	122TA9136
24	45	40	106TA4892

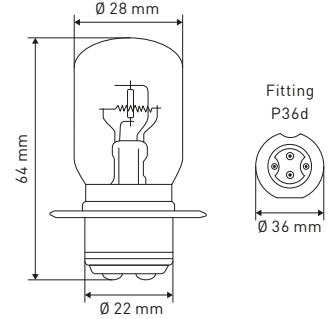

R2

U1 (V)	P1 (W)	P2 (W)	REF
12	45	40	106TA4826
24	55	50	106TA4827

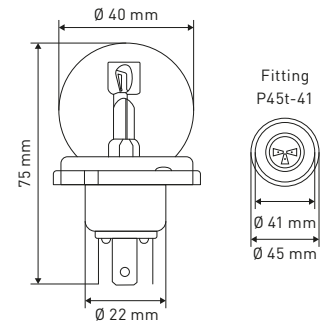

R2

U1 (V)	P1 (W)	P2 (W)	Remark	REF
12	45	40	Yellow	106TA4828
24	55	50	Yellow	103TA4532

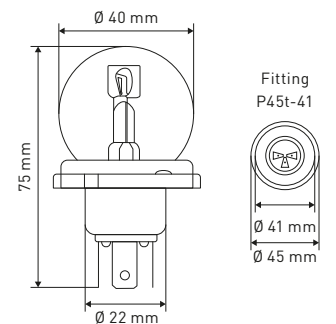



E5

U1 (V)	P1 (W)	REF
24	1,2	142TA1169

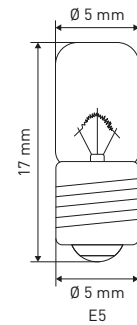

E10

U1 (V)	P1 (W)	REF
12	1,2	106TA4905
24	1	122TA9138
24	1,2	106TA4836
24	2	103TA4544
24	2,4	142TA1293
24	2,8	142TA1232
24	3	131TA4797
30	2	123TA8003
48	2	131TA4798
48	3	122TA9139
55	2	103TA4546
60	3	123TA8004
80	2	122TA9140
80	3,2	119TA8928

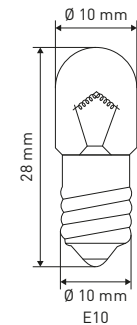



E10

U1 (V)	P1 (W)	REF
12	2,2	122TA9141
12	3	106TA4838
24	3	115TA4608
48	3	142TA1174

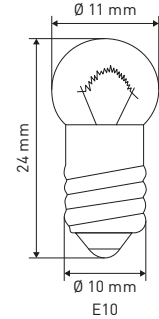

U1 (V)	P1 (W)	REF
12	4	103TA4547
24	5	106TA4835

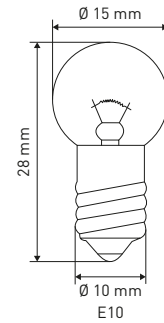

E14

U1 (V)	P1 (W)	REF
12	1,2	103TA4548
12	2	119TA8929
12	3	122TA9142
24	2	122TA9143

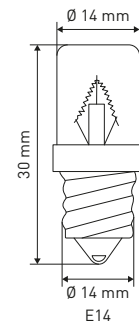



E14

U1 (V)	P1 (W)	REF
12	15	142TA1258
24	5	142TA1173

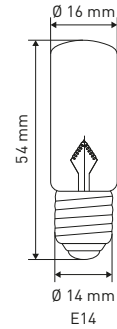

E27

U1 (V)	P1 (W)	Colour temperature (K)	REF
24	40	2700	142TA1373
24	60	2700	144TA5705

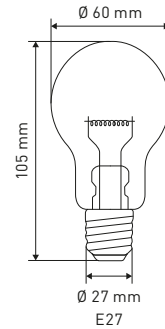

SV7-8

U1 (V)	P1 (W)	REF
12	3	103TA4533
12	5	103TA4534
24	3	103TA4535
24	5	103TA4536
48	3	122TA9147
48	5	122TA9148

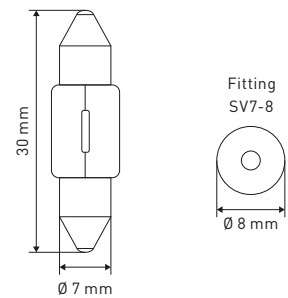



SV8.5-8

U1 (V)	P1 (W)	REF
12	5	103TA4537
12	10	103TA4538
24	5	103TA4539
24	10	106TA4829
48	5	119TA8936

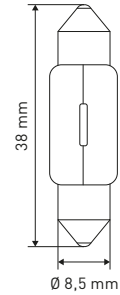

Fitting
SV8.5-8

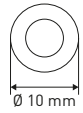

U1 (V)	P1 (W)	REF
6	10	106TA4834
12	5	106TA4830
12	10	106TA4831
24	5	103TA4540
24	10	106TA4907
48	5	119TA8937

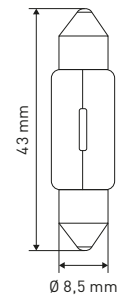

Fitting
SV8.5-8

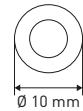

U1 (V)	P1 (W)	REF
12	10	131TA4804
12	15	106TA4832
12	18	103TA4541
12	21	106TA4896
24	10	131TA4805
24	15	122TA9149
24	18	106TA4833
24	21	119TA8938
48	10	122TA9150

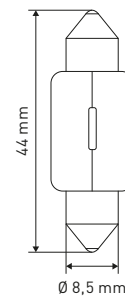

Fitting
SV8.5-8

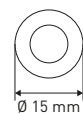



W2X4.6D

U1 (V)	P1 (W)	REF
12	1	103TA4550
12	1,2	123TA8014
12	2	103TA4551
14	1,4	142TA1104
24	1	122TA9151
24	1,2	103TA4553
24	2	122TA9152

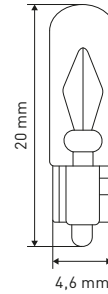

Fitting
W2x4.6d

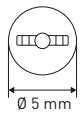

U1 (V)	P1 (W)	REF
12	3	159TA9958
14	3	103TA4552

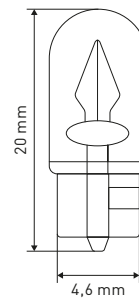

Fitting
W2x4.6d

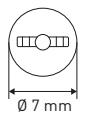

W2.1X9.5D

U1 (V)	P1 (W)	Remark	REF
12	2		123TA8035
12	3		103TA4554
12	3,4		142TA1238
12	5	Orange	159TA9959
12	5		103TA4555
12	6		142TA1231
14	3,8		142TA1131
24	3		103TA4556
24	5		103TA4557
48	2		142TA1284

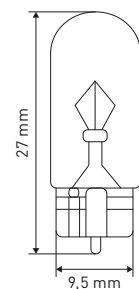

Fitting
W2.1x9.5d

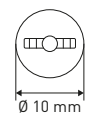



W2.1X9.5D

U1 (V)	P1 (W)	REF
12	10	142TA1296
12	15	142TA1333

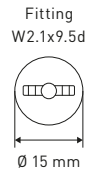
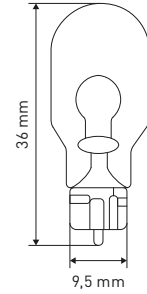

W2.5X16Q

U1 (V)	P1 (W)	P2 (W)	Remark	REF
12	27	7		142TA1260
12	27	7	Orange	159TA9960

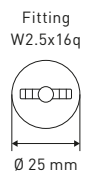
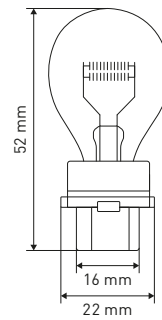

W3X16D

U1 (V)	P1 (W)	Remark	REF
12	21		161TA5788
12	21	Orange	161TA5789

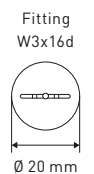
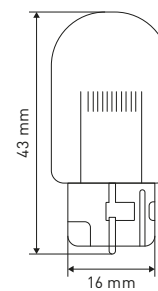



W3X16Q

U1 (V)	P1 (W)	P2 (W)	REF
12	21	5	161TA5790

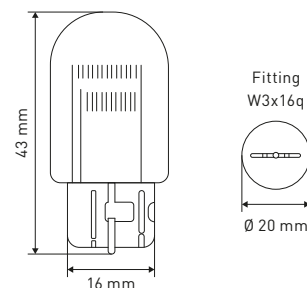

RIGID LOOP

U1 (V)	P1 (W)	REF
12	10	103TA4558

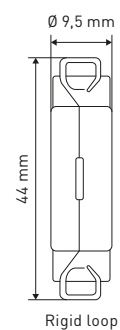

T5.5K

U1 (V)	P1 (W)	REF
12	1,2	131TA4806
24	1,2	131TA4807
30	1,2	159TA9963
48	1,2	122TA9153
60	1,2	159TA9964

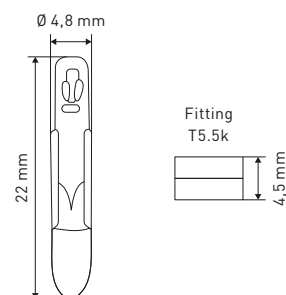



T5.5

U1 (V)	P1 (W)	REF
12	1,2	159TA9966
24	1,2	142TA1282
36	1,2	159TA9965
48	1,2	122TA9166
48	1,44	122TA9167
60	1,2	142TA1299

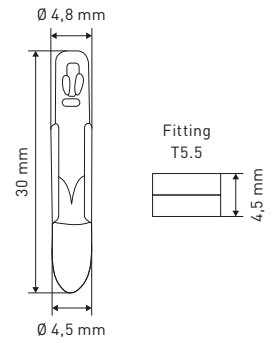

PSB

U1 (V)	P1 (W)	REF
48	2,54	126TA5928

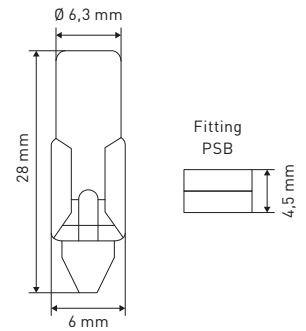

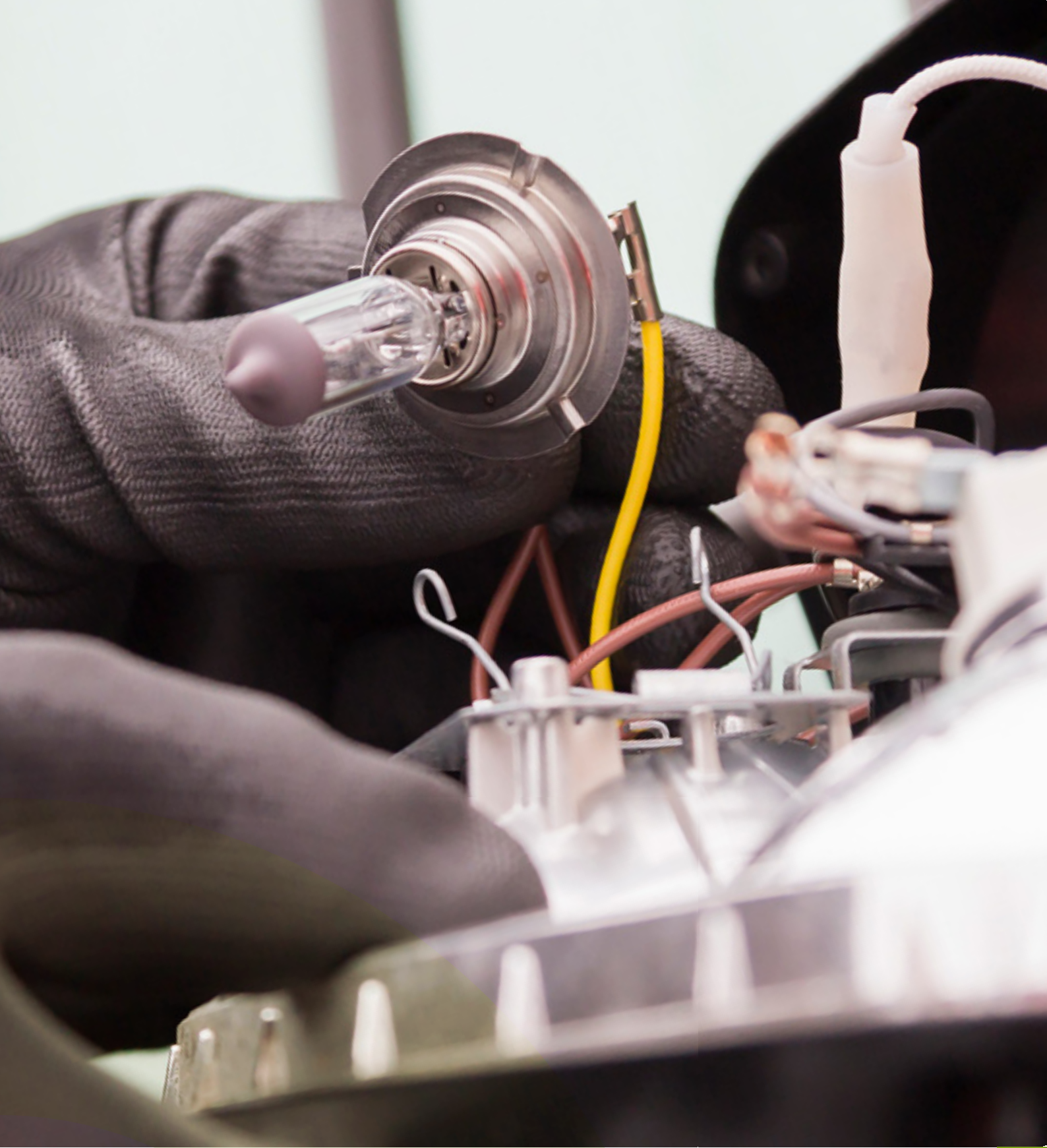

HALOGEN BULBS



NICE TO KNOW – HALOGEN BULBS



Advantages:

- Longer lifespan, up to five times longer than conventional incandescent bulbs
- Bulb can be more accurately directed
- Better luminous efficacy
- Yield up to 25 lumen per watt
- Complete clarity immediately after start-up
- Available with or without reflector
- More compact thanks to the halogen cycle
- The same pleasant colour temperatures as incandescent bulbs

A halogen bulb is basically an incandescent bulb of which the bulb is filled with an inert gas under high pressure. A small amount of halogen is added to the gas (bromine or iodine). Hence the name halogen bulb.

Because of the high temperature, the tungsten sublimates partially and condensates on the much colder glass. Small amounts of iodine and bromine convert the tungsten – mainly what is situated on the glass – into tungsten (III), iodide (WI3), tungsten (IV), chloride (WCl4). As a result of the much higher temperature of the filament itself, the balance shifts to the side of the reagents, so that the tungsten is deposited on the filament, slightly reversing the sublimation losses. Since the highest temperatures occur on the places where the filament is thinnest, the material precipitates where the need is highest, which prevents the filaments from burning out.

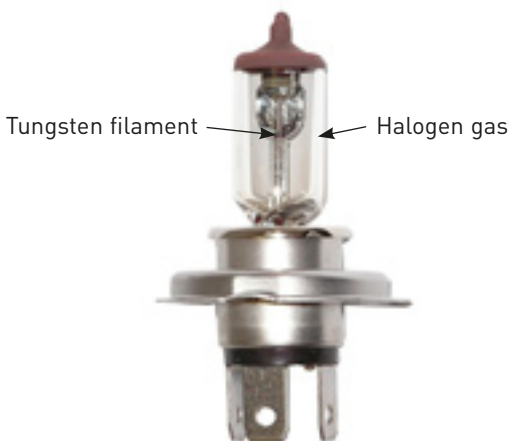

Halogen bulbs reach much higher temperatures than incandescent light bulbs. Touching them with the fingers can cause organic material (greasy fingerprints) to remain on the bulb, resulting in brown spots due to carbonisation after burning.

This dark residue will then result in a higher heating of the bulb end, a significant shortening of the lifespan of the bulb.



BA9S

U1 (V)	P1 (W)	REF
12	5	141TA9742
12	20	141TA9760

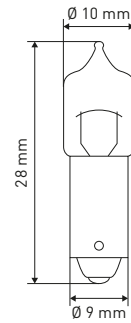

BAY9S

U1 (V)	P1 (W)	REF
12	21	160TA1078
24	21	160TA1077

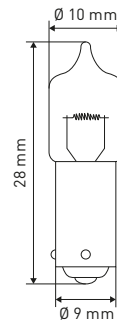

BA15D

U1 (V)	P1 (W)	REF
12	10	141TA9819
12	20	141TA9820

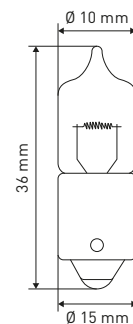



H1

U1 (V)	P1 (W)	Remark	REF
6	55		<u>160TA1079</u>
12	55		<u>123TA8005</u>
12	55	Heavy-duty	<u>142TA1281</u>
12	100		<u>103TA4521</u>
24	55		<u>119TA8930</u>
24	70		<u>123TA8006</u>
24	70	Heavy-duty	<u>142TA1259</u>

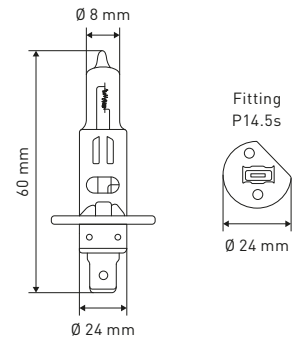

H2

U1 (V)	P1 (W)	REF
12	55	<u>103TA4522</u>
24	70	<u>103TA4523</u>

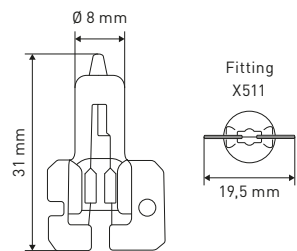



H3

U1 (V)	P1 (W)	Remark	REF
6	25		119TA8931
6	55		119TA8932
12	35		141TA9695
12	55		123TA8007
12	55	Heavy-duty	142TA1110
12	100		103TA4527
15	50		142TA1208
24	35		131TA4799
24	55		119TA8933
24	70		123TA8008
24	70	Heavy-duty	142TA1244
24	100		142TA1292
36	45		123TA8009
48	35		131TA4801
48	45		123TA8010
48	60		123TA8011
80	55		103TA4675

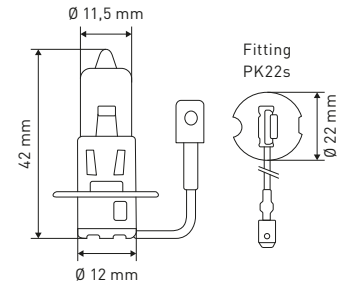

H4

U1 (V)	P1 (W)	P2 (W)	REF
12	45	40	163TA8853
12	60	55	123TA8012
12	100	55	103TA4528
12	100	80	119TA8935
12	100	90	103TA4529
24	75	70	123TA8013
24	100	70	160TA1081
24	100	90	160TA1082

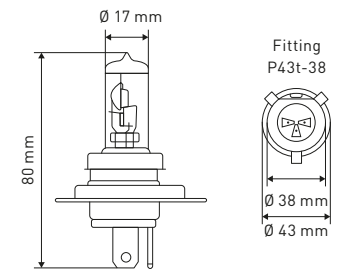

U1 (V)	P1 (W)	P2 (W)	REF
12	45	40	160TA1083
12	60	55	106TA4825
12	100	80	103TA4531
24	75	70	131TA4802

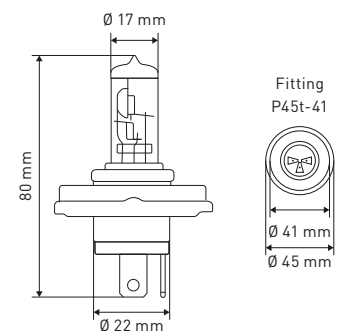



H4

U1 (V)	P1 (W)	P2 (W)	Remark	REF
12	60	55	Yellow	106TA4823
24	75	70	Yellow	142TA1159

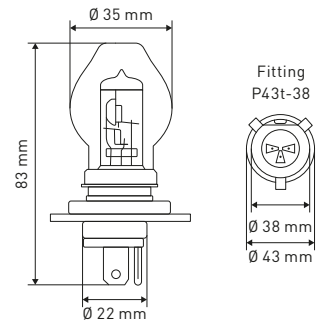

H7

U1 (V)	P1 (W)	REF
12	55	106TA4908
12	100	160TA1085
24	70	106TA4909

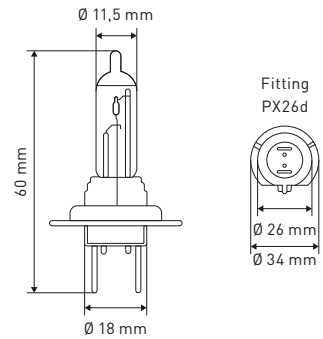

H8

U1 (V)	P1 (W)	REF
12	35	161TA5887

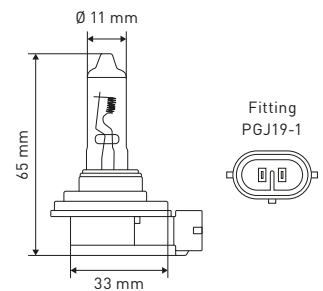

H9

U1 (V)	P1 (W)	REF
12	65	161TA5888

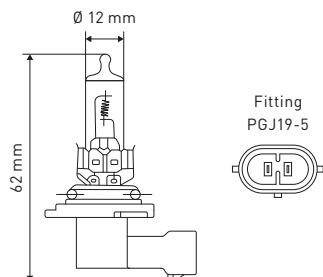



H10 (9145)

U1 (V)	P1 (W)	REF
12	45	161TA5889

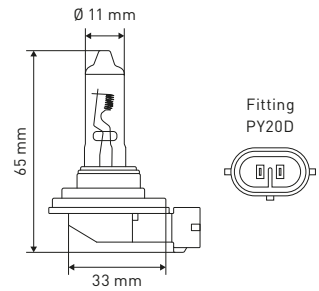

H11

U1 (V)	P1 (W)	REF
12	55	161TA5890
24	70	161TA5891

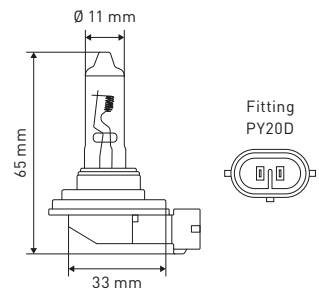

H13 (9008)

U1 (V)	P1 (W)	P2 (W)	REF
12	60	55	161TA5892

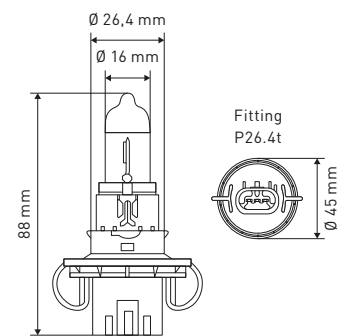

H16

U1 (V)	P1 (W)	REF
12	19	161TA5893

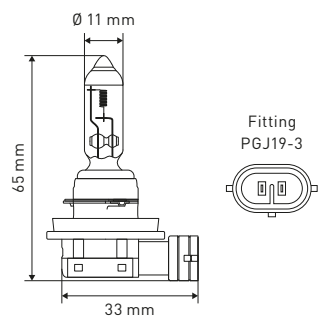



HB1 (9004)

U1 (V)	P1 (W)	P2 (W)	REF
12	65	45	161TA5894

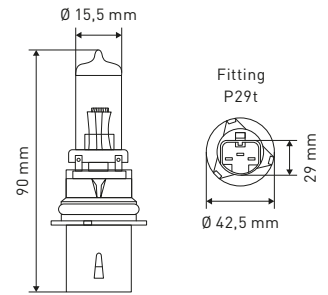

HB3 (9005)

U1 (V)	P1 (W)	REF
12	60	161TA5895

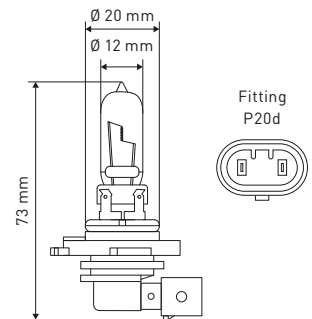

HB4 (9006)

U1 (V)	P1 (W)	REF
12	55	142TA1302

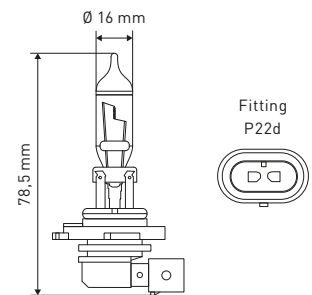

HB5 (9007)

U1 (V)	P1 (W)	P2 (W)	REF
12	65	55	161TA5897

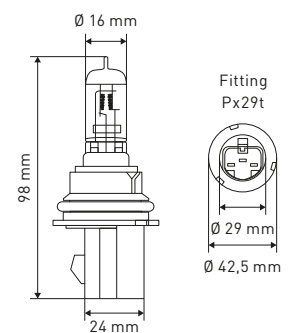



PG13

U1 (V)	P1 (W)	REF
12	27	161TA5898
12	50	161TA5899

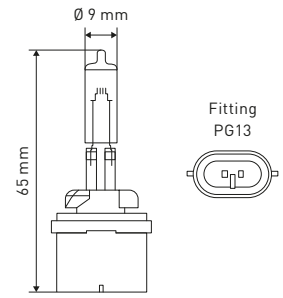

PGJ13

U1 (V)	P1 (W)	REF
12	27	122TA9144
12	37,5	122TA9145
12	50	122TA9146

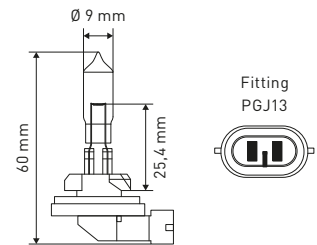

G4

U1 (V)	P1 (W)	Colour temperature (K)	REF
12	20	2800	142TA1316
24	20	2800	142TA1214

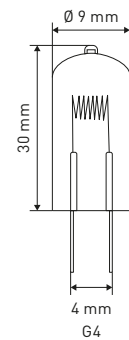

R7S

U1 (V)	P1 (W)	L1 (mm)	Colour temperature (K)	REF
230	240	117	4900	160TA1087
230	400	118	8700	142TA1350
230	1000	190	22 000	142TA1362
230	2000	553	44 000	142TA1368

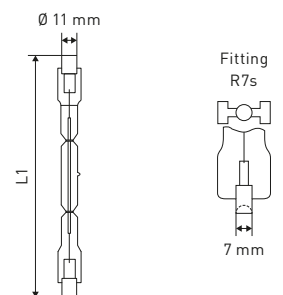



NOTES

A series of horizontal dotted lines for writing notes.



FLUORESCENT BULBS



NICE TO KNOW – FLUORESCENT BULBS



A fluorescent bulb produces light when a fluorescent layer inside the bulb is hit by ultraviolet radiation, generated during the gas discharge inside the bulb. The most common example of this are the well-known fluorescent tubes and low-energy light bulbs. The light output in lumen per watt is 5 to 6 times greater than an incandescent bulb.

Principle:

The inside of a tube is covered in a fluorescent layer and filled with a noble gas (argon, krypton or a mixture of both) and mercury vapour under low pressure. An electric discharge takes place between the two electrodes on each side of the tube, causing the mercury vapour to radiate ultraviolet light. The fluorescent layer then converts the ultraviolet light into visible light.

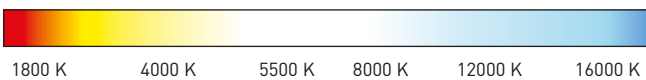

Advantages:

High energy-efficiency and light streams

Disadvantages:

Large dimensions

Old colour code	New colour code	Colour
29	530	Warm white
35	535	Neutral white
33	640	Cool white
25	740	Standard white
54	765	Cool daylight
	827	Extra warm white
	830	Warm white
	835	Neutral white
	840	Cool white
	865	Cool daylight
	930	Warm white
	940	Cool white
	950	Daylight
	965	Cool daylight
	15	Red
	16	Yellow
	17	Green
	18	Blue



E27

U1 (V)	P1 (W)	Colour temperature (K)	REF
230	8	2700	142TA1357

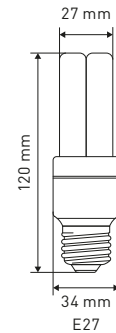

G5

P1 (W)	L1 (mm)	Colour temperature (K)	REF
6	212	3000	142TA1345
8	288	3000	142TA1356
8	288	4000	136TA3029
13	515	4000	142TA1343

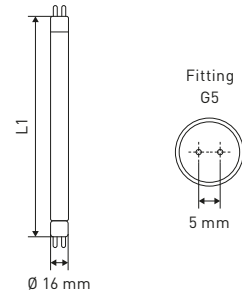

2G7

P1 (W)	L1 (mm)	Colour temperature (K)	REF
7	114	4000	142TA1347
11	214	4000	142TA1344

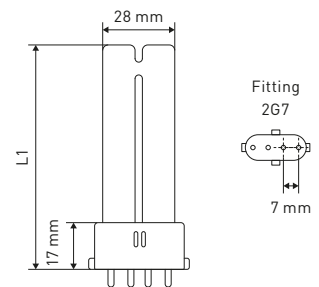

2G11

P1 (W)	L1 (mm)	Colour temperature (K)	REF
18	220	2700	142TA1363
36	411	4000	142TA1103

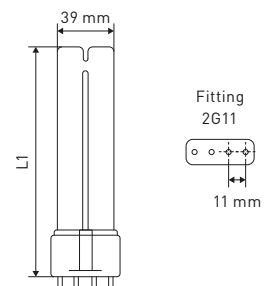



G23

P1 (W)	L1 (mm)	Colour temperature (K)	REF
11	235	4000	142TA1335

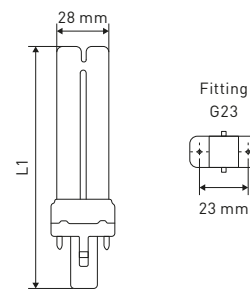



HIGH INTENSITY DISCHARGE BULBS



NICE TO KNOW – HIGH INTENSITY DISCHARGE BULBS



D1S + D3S



D2S + D4S

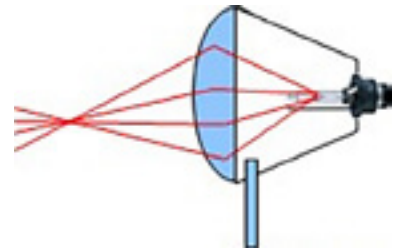

D1R + D3R



D2R + D4R

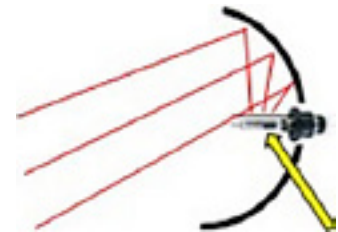

A xenon arc bulb is a gas discharge bulb in which a light arc is generated within xenon gas under high pressure. This creates a nearly point-shaped light source with a high luminance.

A gas discharge bulb is an artificial light source that produces light by sending an electric current through ionised gas. Xenon is the gas used for this bulb.

Tips:

- If you have installed the bulb correctly and it doesn't light up, then the ballast is faulty and not the bulb.
- Don't touch the bulb with your bare hands.
- When changing one bulb, also replace the other one to prevent colour differences.

Advantages:

- Generates up to 3 times the amount of light
- Longer and wider light image
- Up to 7 times the life span
- Lower power consumption
- Xenon bulbs use 35 W, which is less than a H4 (60 W) and H7 (55 W)



D1S

U1 (V)	P1 (W)	REF
85	35	144TA5693

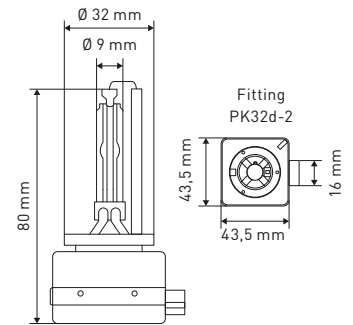
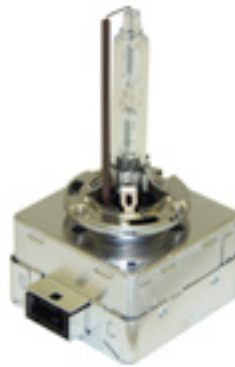

D1R

U1 (V)	P1 (W)	REF
85	35	147TA4298

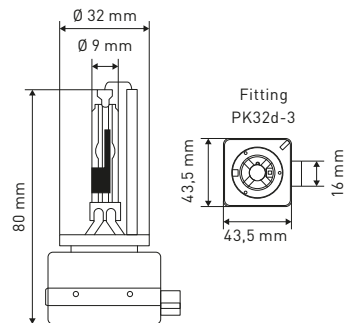

D2S

U1 (V)	P1 (W)	REF
85	35	142TA1265

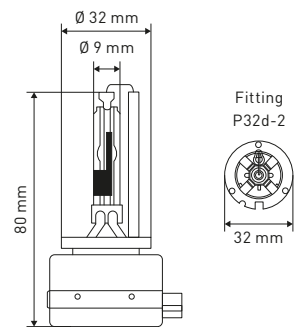

D2R

U1 (V)	P1 (W)	REF
85	35	161TA5904

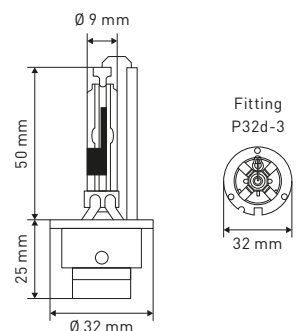



MVR 1000/BT 37

- Peak lead ballast: 750V
- RMS lag ballast: 530V

P1 (W)	Colour temperature (K)	REF
1000	4000	<u>161TA5955</u>

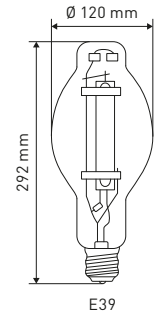

MVR 1000/BT 56

- Peak lead ballast: 750V
- RMS lag ballast: 530V

P1 (W)	Colour temperature (K)	REF
1000	4000	<u>142TA1084</u>

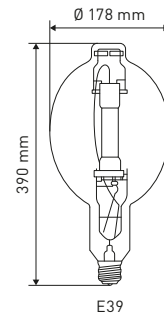



SPARE KITS/ DASHBOARD BULBS



NICE TO KNOW – SPARE KITS/DASHBOARD BULBS



Are you hitting the road soon? Make sure you are properly and correctly equipped. You will find what you need in this overview.

Advantages:

- Robust packaging
- High quality
- Different types
- Multiple by species

1. First aid kit

REF 140TA8638

2. Safety jackets

REF 141TA7655 – S/M

REF 141TA7656 – L/XL

REF 141TA7657 – XXL/XXXL

3. Emergency triangle

REF 107TA8060

4. Fire extinguisher

REF 107TA8110 – 1 kg

1



2



3



4



Country	Spare bulbs	First-aid kit	High-visibility safety vest	Emergency triangle	Fire extinguisher
Austria	R	M	M	M	R
Belgium	R	M	M	M	M
Bulgaria	M	M	M	M	M
Croatia	M	M	M	M	M*
Czech Republic	R	M	M	M	N
Denmark	R	R	R	M	R
Estonia	R	M	M	M	M
Finland	R	R	R	M	R
France	R	R	M	M	R
Germany	R	M	M	M	R
Hungary	N	M	M	M	N
Italy	R	R	M	M	R
Latvia	R	M	R	M	M
Lithuania	R	M	M	M	M
Luxembourg	R	R	M	M	R
Norway	R	R	M	M	R**
Poland	M	N	N	M	M
Sweden	N	N	R	M	N**
Switzerland	N	N	N	M	N
The Netherlands	R	R	R	M	R

M = mandatory · R = recommended · N = no actual legislation

M* only at commercial vehicles

** coaches only



B8.3D

U1 (V)	P1 (W)	Remark	REF
12	1,2	Black	142TA1331
12	2	Blue	160TA1100
24	1,2	Grey	160TA1109

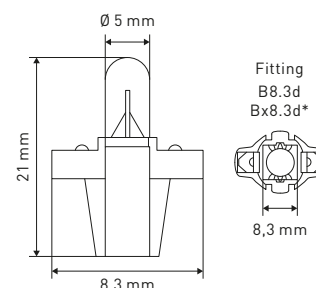

Fitting
B8.3d
Bx8.3d*

B8.4D

U1 (V)	P1 (W)	Remark	REF
12	1,1	Orange	160TA1095
12	1,2	Black	160TA1096
12	1,2	Blue	160TA1097
12	1,3	Olive green	160TA1117
12	1,5	Beige	160TA1098
12	1,8	Beige	160TA1118
12	2	Light green	160TA1099
24	1,2	Brown	142TA1349

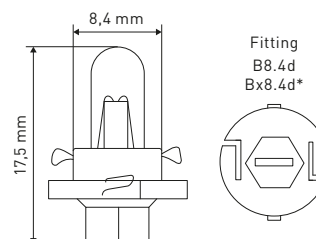

Fitting
B8.4d
Bx8.4d*

B8.5D

U1 (V)	P1 (W)	Remark	REF
12	0,4	Lila	160TA1093
12	1	Orange	160TA1092
12	1,12	White	160TA1119
12	1,2	Blue	160TA1091
12	1,2	Black	122TA9154
12	1,5	Beige	160TA1094
12	2	Green	122TA9155
12	2	Light green	160TA1116
24	1,2	Grey	122TA9156
24	1,2	Brown	160TA1108

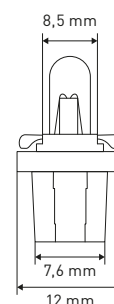

Fitting
B8.5d
Bx8.5d*



B8.7D

U1 (V)	P1 (W)	Remark	REF
12	1,2	Grey	161TA5915
12	2	Green	142TA1321
24	1,2	Brown	160TA1110

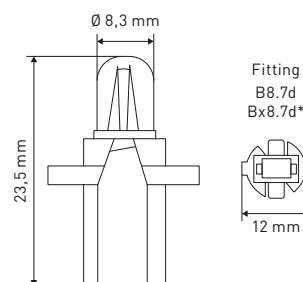

B10D

U1 (V)	P1 (W)	Remark	REF
12	3	Brown	160TA1104
12	5	Black	160TA1105

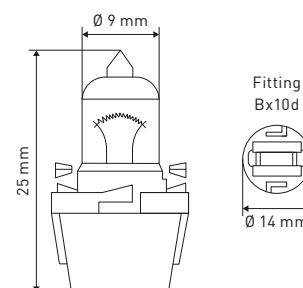

MFHZ

U1 (V)	P1 (W)	Remark	REF
12	1,2	Black	160TA1101

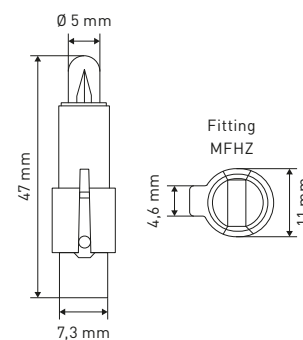

MFJF

U1 (V)	P1 (W)	Remark	REF
12	1,2	Black	160TA1102

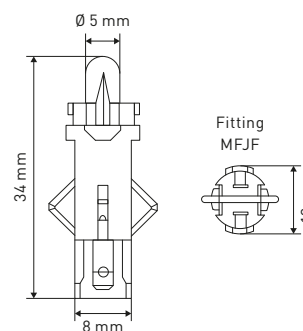



MFSL

U1 (V)	P1 (W)	Remark	REF
12	1,2	Black	160TA1103

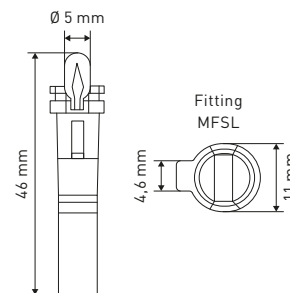

EBSR

U1 (V)	P1 (W)	Remark	REF
12	1,2	Brown	160TA1112
24	1,2	Yellow	160TA1113
24	1,4	Light green	160TA1114

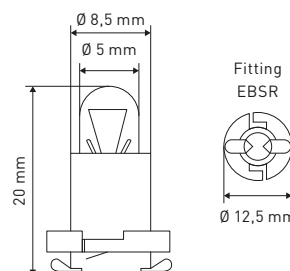

T5

U1 (V)	P1 (W)	Remark	REF
12	1,2	Brown	142TA1201
12	2	Black	142TA1252
14	2	Black	142TA1082
14	1,4	Black	161TA5906
14	1,4	Green	161TA5907
24	1,2	Grey	161TA5908
24	1,4	Brown	161TA5909
24	1,4	Grey	142TA1241
24	1,8	Red	142TA1233
24	2	Brown	161TA5910

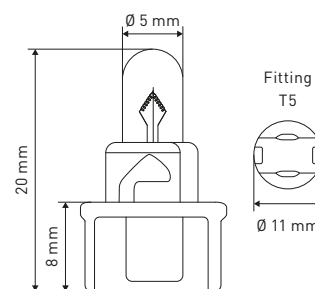



T6.5

U1 (V)	P1 (W)	Remark	REF
14	3	Grey	144TA5650
14	3	Black	142TA1317
14	3	Red	142TA1094
14	3	Blue	161TA5911
24	3	Grey	142TA1090

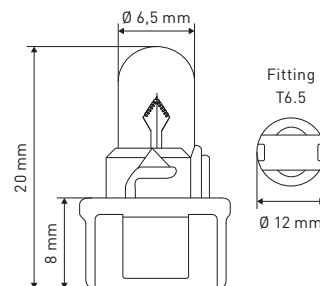

T10

U1 (V)	P1 (W)	Remark	REF
12	3	Black	142TA1243
12	5	Black	142TA1287
24	3	Black	142TA1235
24	3	Brown	142TA1294

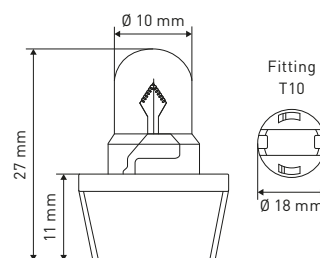

T10 YAZAKI

U1 (V)	P1 (W)	Remark	REF
12	3	Black	142TA1237
14	3,4	Green	161TA5912
14	3,8	Green	161TA5913

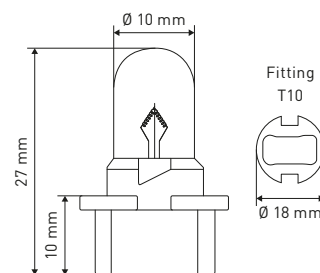

KW2X4.6D

U1 (V)	P1 (W)	Remark	REF
12	1,2	White	159TA9962
24	1	White	160TA1111
24	1,2	White	159TA9961
48	1,2	Beige	103TA4559
48	1,2	Black	161TA5914

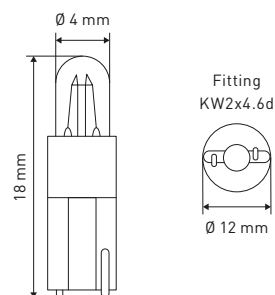



DASHBOARD KIT 12V

U1 (V)	P1 (W)	Remark	ECE fitting	Quantity box	REF
12	0,4	Lila	B8,5D	5	160TA1093
12	1	Orange	B8,5D	5	160TA1092
12	1,1	Orange	B8,4D	5	160TA1095
12	1,2	Black	B8,3D	5	142TA1331
12	1,2	Black	B8,4D	5	160TA1096
12	1,2	Blue	B8,4D	5	160TA1097
12	1,2	Blue	B8,5D	5	160TA1091
12	1,2	Black	B8,5D	5	122TA9154
12	1,2	Black	MFHZ	5	160TA1101
12	1,2	Black	MFJF	5	160TA1102
12	1,2	Black	MFSL	5	160TA1103
12	1,5	Beige	B8,5D	5	160TA1094
12	1,5	Beige	B8,4D	5	160TA1098
12	2	Blue	B8,3D	5	160TA1100
12	2	Light green	B8,4D	5	160TA1099
12	2	Green	B8,5D	5	122TA9155
12	3	Brown	B10D	5	160TA1104
12	5	Black	B8,5D	5	160TA1105



REF [160TA1089](#) – Complete box

TOTAL SOURCE[®]

DASHBOARD KIT 24V

U1 (V)	P1 (W)	Remark	ECE fitting	Quantity box	REF
24	1	White	Kw2x4,6D	5	160TA1111
24	1,2	Clear	W2x4,6D	5	103TA4553
24	1,2	Grey	B8,3D	5	160TA1109
24	1,2	White	B8,4D	5	142TA1349
24	1,2	Grey	B8,5D	5	122TA9156
24	1,2	Brown	B8,5D	5	160TA1108
24	1,2	Brown	B8,7D	5	160TA1110
24	1,2	Yellow	EBS R4	5	160TA1113
24	1,2	Brown	EBS R11	5	160TA1112
24	1,4	Green	EBS R11	5	160TA1114
24	3	Clear	W2,1x9,5D	5	103TA4556
24	5	Clear	W2,1x9,5D	5	103TA4557



REF [160TA1106](#) – Complete box

TOTAL SOURCE[®]



DASHBOARD BULB KIT 12V

U1 (V)	P1 (W)	Remark	ECE fitting	Quantity box	REF
12	2	Blue	B8,7D	10	160TA1100
12	1,1	Orange	B8,4D	10	160TA1095
12	1,12	White	B8,5D	10	160TA1119
12	1,2	Black	B8,3D	10	142TA1331
12	1,2	Black	B8,5D	10	122TA9154
12	1,2	Blue	B8,5D	10	160TA1091
12	1,2	Blue	B8,4D	10	160TA1097
12	1,2	Black	B8,4D	10	160TA1096
12	1,3	Olive green	B8,4D	10	160TA1117
12	1,5	Beige	B8,4D	10	160TA1098
12	1,8	Beige	B8,4D	10	160TA1118
12	2	Light green	B8,4D	10	160TA1099
12	2	Green	B8,5D	10	122TA9155
12	2	Light green	B8,5D	10	160TA1116
12	3	Brown	B10D	10	160TA1104
12	5	Black	B10D	10	160TA1105
		Mounting tool			



REF [160TA1115](#) – Complete box

PHILIPS

KIT H1 – 12V

U1 (V)	P1 (W)	P2 (W)	Remark	ECE fitting	Quantity box	REF
12	4			T4W	1	145TA2682
12	5			R5W	1	145TA2680
12	5			C5W	1	160TA1122
12	21			P21W	1	145TA2673
12	21	5		P21/5W	1	145TA2099
12	55			H1	1	145TA2684
			Fuse 15A		1	106TA4955
			Fuse 20A		1	106TA4956
			Fuse 30A		1	103TA2770



REF [160TA1127](#) – Complete box

PHILIPS



KIT H4 – 12V

U1 (V)	P1 (W)	P2 (W)	Remark	ECE fitting	Quantity box	REF
12	4			T4W	1	145TA2682
12	5			R5W	1	145TA2680
12	5			C5W	1	160TA1122
12	21			P21W	1	145TA2673
12	21	5		P21/5W	1	145TA2099
12	60	55		H4	1	160TA1121
			Fuse 15A		1	106TA4955
			Fuse 20A		1	106TA4956
			Fuse 30A		1	103TA2770



REF [160TA1120](#) – Complete box

PHILIPS

KIT H7 – 12V

U1 (V)	P1 (W)	P2 (W)	Remark	ECE fitting	Quantity box	REF
12	4			T4W	1	145TA2682
12	5			R5W	1	145TA2680
12	5			C5W	1	160TA1122
12	21			P21W	1	145TA2673
12	21	5		P21/5W	1	145TA2099
12	55			H7	1	145TA2681
			Fuse 15A		1	106TA4955
			Fuse 20A		1	106TA4956
			Fuse 30A		1	103TA2770



REF [160TA1126](#) – Complete box

PHILIPS

KIT H1/H7 – 12V

U1 (V)	P1 (W)	Remark	ECE fitting	Quantity box	REF
12	5		W5W	1	160TA1125
12	10		R10W	1	145TA2676
12	10		SV8.5-8	1	145TA2683
12	21		P21W	1	145TA2673
12	21	Orange	PY21W	1	160TA1124
12	55		H7	1	145TA2681
12	55		H1	1	145TA2684
		Fuse 10A		2	106TA4954
		Fuse 20A		1	106TA4956



REF [160TA1123](#) – Complete box

PHILIPS



KIT H4 – 24V

U1 (V)	P1 (W)	P2 (W)	Remark	ECE fitting	Quantity box	REF
24	4			T4W	1	160TA1133
24	5			R5W	1	160TA1131
24	5			C5W	1	160TA1132
24	10			R10W	1	160TA1130
24	21			P21W	1	145TA2674
24	75	70		H4	1	160TA1129
			Fuse 15A		1	106TA4955
			Fuse 20A		1	106TA4956
			Fuse 30A		1	103TA2770



REF [160TA1128](#) – Complete box

PHILIPS

KIT H7 – 24V

U1 (V)	P1 (W)	Remark	ECE fitting	Quantity box	REF
24	4		T4W	1	160TA1133
24	5		R5W	1	160TA1131
24	5		C5W	1	160TA1132
24	10		R10W	1	160TA1130
24	21		P21W	1	145TA2674
24	70		H7	1	160TA1135
		Fuse 15A		1	106TA4955
		Fuse 20A		1	106TA4956
		Fuse 30A		1	103TA2770



REF [160TA1134](#) – Complete box

PHILIPS



MAINTENANCE, REPAIR & OPERATION



DIGITAL MULTIMETER

REF 142TA3131

- AC/DC voltage: 600 V
- AC/DC current: 10 A
- Diode test
- Transistor test
- Continuity test with buzzer
- Resistance
- Capacitance
- Data hold
- Low battery indication
- Backlight
- 9 V battery and protection holster included
- CAT.II 600 V



FLUKE® 175 – DIGITAL MULTIMETER

Versatile meters for field service or bench repair

These meters have the features needed to find most electrical, electromechanical and heating and ventilation problems.

They are simple to use and have significant improvements over Fluke's original 70 Series like True RMS, more measurement functions, conformance to the latest safety standards, and a much larger display that is easier to view.

Features:

True RMS measurements	AC
Digital display counts, updates 4 times per second	6000
Analog bargraph/33 segments, updates 40 times per second	✓
Auto and manual ranging	✓
Display hold and AutoHOLD®	✓
Min-Max-Average recording mode with Min/Max Alert	✓
Smoothing mode allows filtering of rapidly changing inputs	✓
Audible continuity and diode test	✓
Test lead alert	✓
Unsafe voltage alert warns for voltages above 30 V	✓
Low battery indication	✓
Ergonomic case with integrated holster	✓
Easy battery and fuse exchange without opening the complete case	✓
Selectable sleep mode preserves battery life	✓

Specifications:

Functions	Max range	Max resolution	Accuracy
Voltage DC	1000 V	0,1 mV	± (0,15% + 2)
Voltage AC	1000 V	0,1 mV	± (1,0% + 3)
Current DC	10 A	0,01 mA	± (1,0% + 3)
Current AC	10 A	0,01 mA	± (1,5% + 3)
Resistance	50 MΩ	0,1 Ω	± (0,9% + 1)
Capacitance	10 000 μF	1 nF	± (1,2% + 2)
Frequency	100 kHz	0,01 Hz	± (0,1% + 1)
Temperature	-40 °C to 400 °C	0,1 °C	

Accuracies are best accuracies for each function



REF 131TA8447

Fluke® 175

- Battery life: 200 hours typical (alkaline)
- Size (H x W x D): 190 x 85 x 45 mm
- Weight: 0,42 kg
- Warranty: lifetime



True RMS

On all inputs



Included accessories:

Test leads with 4 mm lantern tips and protective cap, installed 9 V battery and user's manual.

Recommended accessories:



REF 131TA8448 C90 REF 131TA8445 i1010 REF 134TA8375 TLK220 eur

FLUKE®

TVH is an official Fluke® dealer



ALKALINE BATTERIES

Size	Type	Voltage (V)	Blister qty	REF	Box qty	REF/box
	3LR12	4,5	1	106TA9003		
AAA	LR3	1,5	4	106TA9000	10	163TA8917
AA	LR6	1,5	4	106TA9001	40	163TA8918
C	LR14	1,5	2	106TA9002	20	163TA8919
D	LR20	1,5	2	106TA8998	20	163TA8920
E	6LR61	9	1	106TA8999	20	163TA8921



RECHARGEABLE BATTERIES NI-MH

Size	Type	Voltage (V)	mAh	Blister qty	REF
AAA	LR3	1,2	900	4	145TA1813
AA	LR6	1,2	2100	4	145TA1812
C	LR14	1,2	2200	2	164TA9405
D	LR20	1,2	2600	2	141TA6698
E	6LR61	8,4	150	1	141TA6699



BUTTON CELL BATTERIES

Type	Voltage (V)	Units	REF
SR44W	1,55	1	141TA6700
LR44	1,5	1	141TA6701
CR1620	3	1	141TA6702
CR2016	3	1	141TA6703
CR2025	3	1	141TA6704
CR2032	3	1	141TA6705
CR2430	3	1	141TA6706
CR2450	3	1	141TA6707

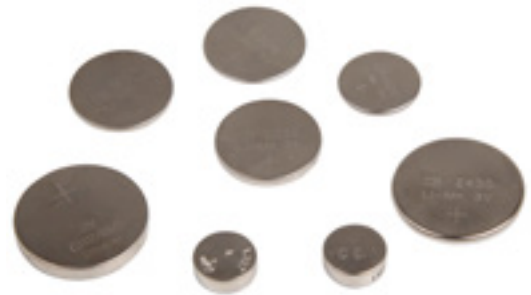

MULTI-CHARGER NIMH



REF [139TA3248](#)

- For batteries AA, AAA, C, D, 9 V
- Possibility to charge 8 batteries at once (8 x AA, 8 x AAA, 4 x C, 4 x D, 1 x 9 V)



CABLE TIES

Width	Length	Pack quantity	REF white	REF black
2,5 mm	98 mm	100 pieces	111TA3872	111TA3884
3,6 mm	140 mm	100 pieces	111TA3873	111TA3885
4,5 mm	160 mm	100 pieces	111TA3874	111TA3886
4,8 mm	200 mm	100 pieces	111TA3875	111TA3887
4,8 mm	295 mm	100 pieces	111TA3876	111TA3888
4,8 mm	370 mm	100 pieces	111TA3877	111TA3889
4,8 mm	178 mm	100 pieces	111TA3878	111TA3890
7,8 mm	360 mm	100 pieces	111TA3879	111TA3891
7,8 mm	540 mm	100 pieces	111TA3880	111TA3892
12,6 mm	500 mm	50 pieces	111TA3881	111TA3893
12,6 mm	730 mm	50 pieces	111TA3882	111TA3894
12,6 mm	1000 mm	50 pieces	111TA3883	111TA3895



- Temperature-resistant: -40 °C up to 80 °C
- Melting point: 250 °C
- Resistant against: oil, petrol, seawater, solvents, mold, diluted light organic acids and alkalines



COUNTERSUNK SCREWS AND NUTS M3-M5

REF 107TA5446

- 480 pieces
- Bicro zinc
- Metric
- DIN 965 + 934

Sizes	Quantity	Sizes	Quantity
M3 x 10	10	M6 x 16	40
M3 x 20	10	M6 x 50	40
M4 x 16	10	M3	20
M4 x 30	25	M4	35
M5 x 16	35	M5	105
M5 x 30	20	M6	80
M5 x 40	50		



FINISHED HEXAGON BOLTS AND HEXAGON NUTS M5-M12

REF 131TA6976

- 950 pieces
- Steel 8.8, zinc-plated
- Metric ISO 4017
- DIN 934

Sizes	Quantity	Sizes	Quantity
M5 x 10 mm	100	M10 x 30 mm	10
M5 x 16 mm	75	M10 x 40 mm	10
M5 x 20 mm	60	M12 x 30 mm	5
M6 x 16 mm	50	M12 x 40 mm	5
M6 x 20 mm	50	M5	235
M6 x 25 mm	40	M6	140
M8 x 20 mm	25	M8	70
M8 x 25 mm	25	M10	20
M8 x 30 mm	20	M12	10



3-PIECE STEP DRILL SET



REF 143TA3171

HSS: 4-12, 4-20, 4-30 mm



REFLECTOR FOR FORKLIFT



REF 107TA8060

- Height: 350 mm
- Fixation: triangle
- ECE 27

FIRST-AID KIT EURO

REF 140TA8638

Small first-aid kit which is useful for cars, trekking, camping, boy scout, ...

Contents:

- 1 triangular bandage TNT 96 x 96 x 136 cm
- 2 adhesive plasters 10 x 6 cm
- 1 pair of scissors 10 cm
- 1 plastic tweezers
- 1 cotton wool pack 20 g
- 1 pack of 10 assorted adhesive plasters
- 2 gauze bandages 7 cm
- 1 adhesive plaster roll 5 x 2,5 cm
- 1 pair of gloves
- 2 packs of sterile TNT pads 1 x 1 cm
- 1 PIC
- 3 packs of 8 ass sachets soap/disinfectant/ammonium
- 1 instant ice pack
- Guidance leaflet 5 languages



FIRE EXTINGUISHER

REF 107TA8110

- 1 kg
- Furnace class
- In function of the furnace, we use one or more designated fire extinguishers. The following badges that are located on the fire extinguishers denote the class it is suitable for.

Powder extinguisher supplied with wall-mounting bracket!

Only approved for Belgium!



Class A: wood, paper, textile, carton. These are fires with brand formation, also called 'dry fires'.

Use fire extinguisher with universal ABC powder



Class B: liquid fires (alcohol, oil, grease, paint, hydrocarburates)

Use fire extinguisher with universal ABC powder



Class C: gas fires (gas, methane, butane, propane ...)

Use fire extinguisher with universal ABC powder





SAFETY JACKETS

- REF [123TA5548](#) – Uni-size, yellow
 - REF [123TA5549](#) – Uni-size, orange
 - REF [140TA8863](#) – M, yellow
 - REF [107TA8089](#) – L, yellow
 - REF [107TA8090](#) – XL, yellow
 - REF [107TA8091](#) – XXL, yellow
 - REF [107TA8092](#) – XXXL, yellow
- EN 471



WORKEASY BLACK

- REF [143TA6973](#) – Size: 6
- REF [143TA6974](#) – Size: 7
- REF [143TA6975](#) – Size: 8
- REF [143TA6976](#) – Size: 9
- REF [143TA6977](#) – Size: 10
- REF [143TA6978](#) – Size: 11

Recommendations:

Fine handling in a dry environment

Applications:

- Assembly and electrical components (semi-conductors, microprocessors)
- Separation of small items (household appliances, automotive industry, nuts and bolts)
- Electronic

Advantages:

- Exceptional dexterity and breathability
- Without silicone

Standard:

- Cat II
- EN 420
- EN 388:3121





CONTACT CLEANER

REF 143TA6892

- Effective precision cleaner for electrical/electronic equipment
- Quickly cleans contacts and components
- Removes flux traces, light oils, finger prints and other contaminants
- 500 ml



LECTRA CLEAN II

REF 143TA6898

- Electric motor, parts and equipment degreaser
- Removal of heavy soil like grease, oil, dirt and other contaminants
- Its high flashpoint (63 °C) makes it suitable for use on large pieces and improves application safety
- 500 ml



2-26 ELECTRO

REF 143TA6919

- Multi-purpose maintenance for electrical equipment
- Prevents electrical and electronic malfunction caused by water penetration, humidity, condensation or corrosion
- 500 ml



INSECT CLEANER

REF 107TA8507

- High-quality, intensive cleaner to remove insects
- 500 ml



DE-ICER

REF 139TA3290

- A high-performance de-icer spray, suitable for use on vehicle windscreens. Contains antifreeze to help prevent refreezing
- 500 ml





LOW STRENGTH THREADLOCKER

REF 143TA3464

- Low strength, general purpose
- Max thread size: M36
- Service temperature range: -55 to 150 °C
- Strength: medium
- Breakaway torque: 6 Nm
- Viscosity: 900–1500 mPa·s
- Fixture time: 25 min
- P1 NSF
- 50 ml

Loctite 222:

- Ideal for low-strength thread locking of adjusting screws, countersunk head screws and set screws
- Good on low strength metals which could break during disassembly, e.g. aluminium or brass



LOCTITE

INSTANT ADHESIVE

REF 143TA3515

- Toughened, black, slow
- Service temperature range: -40 to 80 °C
- Viscosity: 200 mPa·s
- Substrates:
 - Plastic: suited
 - Rubber: well suited
 - Metal: suited
- Flexible: suited
- Impact resistance: well suited
- Fixture time: 20–50 sec
- 20 g

Loctite 480:

- For applications where shock resistance is required or shock or peel loads are present
- Ideal for bonding metal to metal, to rubber or magnets
- Good resistance in humid environments



LOCTITE

INSTANT ADHESIVE

REF 143TA3520

- Gap filling, 2-component, low bloom
- Service temperature range: -40 to 80 °C
- Viscosity: gel
- Substrates:
 - Plastic: suited
 - Rubber: well suited
 - Metal: suited
 - Porous and/or acidic surfaces: well suited
- Fixture time: 90–150 sec
- 10 g

Loctite 3090:

- For applications with gaps up to 5 mm or excess of adhesive
- For applications where cosmetic aspects and low bloom is required
- For porous substrates such as wood, paper, leather, cork and fabric



LOCTITE



9-PIECE REVERSIBLE GEAR WRENCH – METRIC



REF 139TA1679

Contents:

9 reversible gear wrenches: 8 – 10 – 11 – 12 – 13 – 14 – 15 – 17 – 19 mm



39-PIECE 1/4" COMBINATION SET

REF 143TA3806

Contents:

-  11 hexagon sockets:
5 - 5,5 - 6 - 7 - 8 - 9 - 10 - 11 - 12 - 13 - 14 mm
-  4 slotted bits:
0,5 x 3 - 0,8 x 5,5 - 1 x 5,5 - 1,2 x 6,5 mm
-  4 Phillips bits:
PH0 - PH1 - PH2 - PH3
-  7 star bits:
T8 - T10 - T15 - T20 - T25 - T30 - T40
-  5 hexagon bits:
3 - 4 - 5 - 6 - 8 mm
- 1 bit holder socket: 1/4" x 1/4"
- 1 x 72-teeth ratchet
- 1 spinner
- 1 sliding T-handle
- 2 extensions: 50 - 150 mm
- 1 universal joint
- 1 adapter: F1/4" x M3/8"



CRIMPING PLIERS



REF 106TA9500

- For cutting cables, stripping wire and crimping insulated terminals
- Capacity: 0,75–6 mm²
- Length: 230 mm





KIT LIGHT TERMINALS

REF 164TA8077

With professional crimp pliers

- | | |
|------------------------|--------------------|
| 50 x L : 6,3 x 0,8 mm | 50 x M8 |
| 50 x L : 25 mm | 50 x L : 25 mm |
| 50 x 6,3 x 0,8 mm | 50 x Ø : 4 mm |
| 50 x M4 | 50 x 6,3 x 0,8 mm |
| 50 x M5 | 50 x Ø : 4 mm |
| 50 x M6 | 50 x 6,3 x 0,8 mm |



12-PIECE INSULATED (1000 V) SLOTTED AND PHILLIPS SCREWDRIVER SET

REF 142TA1927

Contents:

- 7 slotted screwdrivers:
2,4 x 75 – 3 x 100 – 3,5 x 100 – 4 x 100 – 5,5 x 125 –
6,5 x 150 – 8 x 175 mm
- 4 Phillips screwdrivers:
PH0 x 60 – PH1 x 80 – PH2 x 100 – PH3 x 150 mm
- 1 induction circuit tester



3 PIECE PLIERS SET

REF 127TA8106

1169BM/D3

Contents:

- Long needle nose pliers: 160 mm
- Combination pliers: 180 mm
- Diagonal cutter: 160 mm



UNIVERSAL TEST KIT FOR TRAILER SOCKET

REF 124TA2765 – 12V 7-pole

REF 134TA9204 – 12V 13-pole

- 1 test plug for testing the trailer wiring including the trailer lighting (battery included) (1 person)
- 1 test plug for testing the wiring of the trailer socket (2 persons)





NOTES

A series of horizontal dotted lines for taking notes, filling most of the page.



A series of horizontal dotted lines for taking notes.



NOTES

A series of horizontal dotted lines for taking notes, filling most of the page.





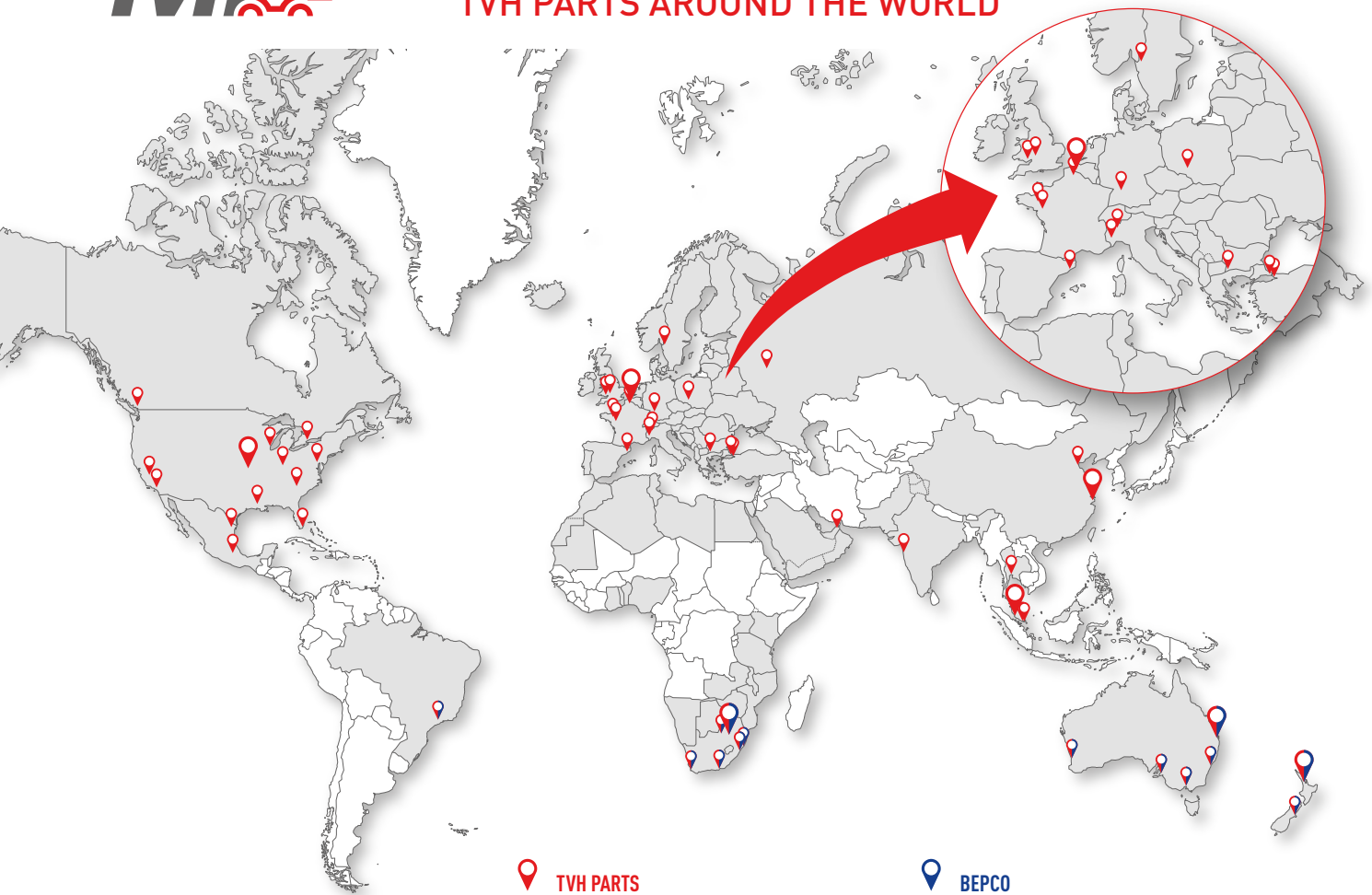





TVH PARTS AROUND THE WORLD



-  **AUSTRALIA**
TVH AUSTRALASIA PTY LTD
Dandenong South (Melbourne, Victoria) -
Richlands (Brisbane, Queensland) -
Welspool (Perth, West Australia) -
Wetherill Park (Sydney, New South Wales) -
Wingfield (Adelaide, South Australia)
-  **BELGIUM**
TVH PARTS NV
Waregem
TVH GROUP NV
Waregem
-  **BRASIL**
TVH-DINAMICA PEÇAS LTDA
Vinhedo
-  **BULGARIA**
TVH BULGARIA LTD
Petrich
-  **CANADA**
TVH CANADA LTD
Mississauga (Ontario) - Port Coquitlam (British Columbia)
-  **CHINA**
TVH TRADING (SHANGHAI) CO, LTD
Shanghai - Tianjin
-  **FRANCE**
TVH FRANCE SASU
Wattrelos
FRANCE HAYON SERVICE SAS
Châteaubourg
GLACES DISTRIBUTION INTERNATIONALE - G.D.I. SAS
Beaufort-en-Vallée
-  **GERMANY**
GLASSINTER GMBH
Kirchheim unter Teck

-  **TVH PARTS**
-  **INDIA**
TVH INDIA PVT LTD
Pune
-  **ITALY**
TVH ITALIA SRL
Marano Ticino (Novara) - Torino
CAM SRL
Marano Ticino (Novara)
-  **MALAYSIA**
TVH MALAYSIA SDN BHD
Johor Bahru - Shah Alam (Kuala Lumpur)
-  **MEXICO**
TVH MEXICO, S DE RL DE CV
Cuautitlán Izcalli (Mexico City) - Monterrey
-  **NEW ZEALAND**
TVH NEW ZEALAND LTD
Christchurch - East Tamaki (Auckland)
-  **POLAND**
TVH POLSKA SP ZOO
Tychy
-  **RUSSIA**
TVH RUS LLC
Dubrovka (Moscow)
-  **SINGAPORE**
TVH SINGAPORE PTE LTD
Jurong
-  **SOUTH AFRICA**
TVH PARTS SOUTH AFRICA LTD
Briardene (Durban) - Isando (Johannesburg) -
Korsten (Port Elizabeth) - Kraaifontein (Cape Town) - Lichtenburg -
Richards Bay

-  **BEPCO**
-  **SPAIN**
TVH IBERICA 2008 SL
Badalona (Barcelona)
-  **SWEDEN**
TVH NORDIC AB
Ed
-  **THAILAND**
TVH PARTS (THAILAND) LIMITED
Bangkok
-  **TURKEY**
TVH YEDEK PARCA TICARET AŞ
Arnavutköy (Istanbul, European) - Tuzla (Istanbul, Asian)
-  **UNITED ARAB EMIRATES**
TVH MIDDLE EAST FZE
Sharjah
-  **UNITED KINGDOM**
TVH UK LTD
Coventry
RENTACLAMP (COVENTRY) LIMITED
Coventry
CAB PARTS & ACCESSORIES LIMITED
Crickhowell
-  **USA**
TVH PARTS CO
Duncan (South Carolina) - Fresno (California) - Grayslake (Illinois) -
Harrisburg (Pennsylvania) - Miami (Florida) - Mira Loma (California) -
Olathe (Kansas) - Shreveport (Louisiana)
C-TECH INDUSTRIES LLC
West Chester Township (Ohio)
SUPERIOR SIGNALS, INC
Olathe (Kansas)

SALES REPRESENTATION IN THE FOLLOWING COUNTRIES:

Albania, Algeria, Austria, Bahrain, Belarus, Benin, Bosnia, Botswana, Canary Islands, Croatia, Cyprus, Denmark, Djibouti, Egypt, Estonia, Finland, Ghana, Greece, Hong Kong, Iceland, Ireland, Kosovo, Kuwait, Latvia, Lesotho, Libya, Lithuania, Macedonia, Malawi, Malta, Morocco, Mauritania, Moldova Republic, Montenegro, Mozambique, Namibia, Nigeria, Norway, Oman, Pakistan, Portugal, Qatar, Saudi Arabia, Serbia, Slovenia, Swaziland, Switzerland, Taiwan, Togo, Tunisia, Ukraine, Yemen, Zambia, Zimbabwe.



Go to **downloads** on www.tvh.com to find all catalogues.

Consumables & accessories

REF 21713862

Our Consumables & accessories catalogue contains an extensive range of safety products for your personnel, machines and warehouse, all types of tools, a wide variety of warehouse equipment, a wide range of oils, sprays, paint & accessories and practical accessories for your lift truck or warehouse equipment.

Engine parts

REF 34167446

Our Engine parts catalogue contains an overview of engine parts for all different brands. Pistons, liners, valves, valve guides, bearings, gasket kits ...



AT YOUR SERVICE
IN 37 LANGUAGES
info@tvh.com

REF-31072165 · 10-2017 · edition 1 · SL · Value: € 10,-



Quality parts cheaper



FOLLOW US



PARTS & ACCESSORIES



COMPANY MOVIE



TVH PARTS NV
Brabantstraat 15 · 8790 Waregem · Belgium
T +32 56 43 42 11 · F +32 56 43 44 88 · info@tvh.com · www.tvh.com

TVH PARTS