



TMH ®





Catalogue

SEATS & ACCESSORIES





 Most articles stated in this catalogue are available from stock, unless they were sold out after the publication of this catalogue. Contact us if you require a similar article that is not shown in this catalogue: alternatives might be available. TVH is a supplier of spare parts and accessories suitable for OEM-equipment. OEM-references and makes are purely indicative and do not imply that the accessories and/or spare parts originate from the original equipment or parts manufacturer. Please consult our general terms and conditions of sale on www.tvh.com/avv.



 De meeste in deze catalogus vermelde artikelen zijn uit voorraad leverbaar, tenzij ze na publicatie van deze catalogus uitverkocht werden. Contacteer ons indien u een gelijkaardig artikel wenst dat niet in deze catalogus is opgenomen: het is mogelijk dat wij ook dit kunnen leveren. TVH is een leverancier van reserveonderdelen en accessoires geschikt voor OEM-uitrusting. OEM-referenties en merken zijn enkel indicatief en betekenen niet dat de accessoires en/of onderdelen afkomstig zijn van de originele toestel- of onderdelenfabrikant. Gelieve onze algemene verkoopsvoorwaarden te consulteren op www.tvh.com/avv.

 La plupart des articles mentionnés dans ce catalogue sont disponibles sauf si épuisement du stock à la publication de ce catalogue. Contactez-nous si vous souhaitez un article similaire qui n'est pas repris dans ce catalogue : il est possible que nous pouvons vous le fournir. TVH est un fournisseur de pièces détachées et d'accessoires adaptables sur des marques constructeurs. Les références et marques constructeurs sont uniquement indicatives et n'impliquent pas que les accessoires et/ou pièces proviennent du fabricant de la machine ou de la pièce d'origine. Veuillez consulter nos conditions générales de vente sur www.tvh.com/avv.

 Die in dieser Liste aufgeführten Artikel sind in der Regel ab Lager lieferbar es sei denn, sie sind nach der Veröffentlichung des vorliegenden Katalogs ausverkauft. Kontaktieren Sie uns wenn Sie einen ähnlichen Artikel benötigen dieser aber nicht im Katalog enthalten ist: Alternativen könnten verfügbar sein. TVH ist Lieferant von Ersatzteilen und Zubehör die für die OEM – Ausstattung geeignet sind. OEM-Referenzen und Marken sind rein Indikativ und bedeuten nicht, dass das Zubehör und/oder Ersatzteile vom Originalgeräte- oder Ersatzteilhersteller sind. Druckfehler vorbehalten. Alle Verkäufe unterliegen den Allgemeinen Geschäftsbedingungen www.tvh.com/avv.

 La mayoría de los artículos que figuran en este catálogo se encuentran en stock, a menos que tras la publicación de este catálogo se hayan agotado. Contacte con nosotros si desea un artículo similar que no se halle en este catálogo : es posible que podamos ofrecerle aquel que usted necesita. TVH es un proveedor de recambios y accesorios adecuados para equipos OEM. Las referencias y marcas OEM mencionadas son meramente indicativas y no implican que los accesorios y / o recambios procedan del fabricante de maquinaria o recambios original. Por favor, consulte nuestras condiciones de venta en www.tvh.com/avv.

 La maggior parte dei ricambi elencati in questo catalogo sono a stock, a meno che dopo la pubblicazione di questo catalogo sono stati venduti. Contattecì se desiderate un articolo simile che non è riportato in questo catalogo: è possibile che possiamo offrire anche questi. TVH è un fornitore di pezzi di ricambio e accessori per OEM, riferimenti OEM e marche sono solo indicativi e non implicano che gli accessori e/o di componenti derivino dal costruttore originale o dal produttore del componente. Si prega di consultare i nostri termini di vendita su www.tvh.com/avv.

 Części z tego katalogu są zazwyczaj na stanie magazynowym. Również części które nie są wyszczególnione w katalogu mogą być dostarczone na zamówienie w najkrótszym możliwym terminie. Opis części O.E.M. jest używany informacyjnie i nie wskazuje na to, że dany produkt jest wyprodukowany przez podanego producenta. Zawartość katalogu może ulec zmianie bez wcześniejszego informowania o tym. Wszystkie użyte zdjęcia, rysunki, nazwy marek, opis i numery służą tylko do identyfikacji.

 Запчасти из настоящего списка, как правило, имеются в запасе, если только он не распродан. Прочие, не фигурирующие в списке артикулы, могут быть поставлены в самые кратчайшие сроки. Указание оригинальных номеров производителя не предполагает обязательного оригинального происхождения самих деталей. Данный список может изменяться без предварительного уведомления. Все использованные фото, рисунки, иллюстрации, названия брендов, наименования и номера служат исключительно для цели идентификации.



WE SPEAK YOUR
LANGUAGE
info@tvh.com



TVH HISTORY



Dear customer,

More than 45 years ago, in 1969, the success story of TVH began. Mr Paul Vanhalst and Mr Paul Thermote, neighbours and school friends, joined forces and started with the purchase and repair of agricultural machines and used lift trucks.

Increasing industrialisation led to a growing need for lift trucks and lift truck parts. Slowly but surely, TVH was growing into a global player, thanks to the success of the product and customer service, but also thanks to acquisitions.

After all these years, the business is still in family hands and has grown from 2 founders, to a workforce of almost 4000 employees worldwide, in 5 continents. The day-to-day management has now been handed over to the second generation.

TVH has two business units: Parts & Accessories (TVH Parts NV) and Equipment (TVH Equipment NV). TVH Equipment is a specialist in second-hand lift trucks and aerial work platforms.

TVH Parts is your all-round supplier of quality parts and accessories for material handling, industrial vehicles and agricultural equipment.

You get fast answers on any offer, order or technical question from our dedicated sales and technical departments. We continually expand our product range by following new trends and looking for new partnerships, to make sure you will find absolutely everything you need right here at TVH.

The Thermote & Vanhalst families



Watch our company movie.



ALL PARTS, ALL MAKES



All parts, all makes

TVHPARTS

- More than 100 000 m² of warehousing
- Computer-controlled stock management
- More than 600 000 stock items
- More than 21 000 000 known references
- Technically-skilled employees
- Assistance in 32 languages
- Same-day shipment, next-day delivery
- One-stop shop
- Webshop & online support



STRONG BRANDS, GUARANTEED QUALITY

Every day, reliable products and services contribute to the success of your company. That is why our product range consists of qualitative top brands.

Read all about this under 'Product range' on www.tvh.com



This is only a selection of brands we can offer. Exceptions apply to certain products/countries.



HYDRAULIC AND MECHANICAL ATTACHMENTS

Benefit from over 50 years of experience in design and production with CAM System® attachments. The full range of mechanical and hydraulic attachments is recognised for its high qualitative standards and reliability: sidershifters, (multi-)fork positioners, rotators, box rotators, bale clamps, appliance clamps, concrete block clamps, push-pulls ...

Order your catalogue with prices to get an overview of this product range. Find our product leaflets and product movies on www.camsystem.com. In addition to complete attachments, we also offer replacement parts.



REF 24891677



SWEEPERS

Sweep your way through dust and dirt!

We offer a complete range of mechanical and hydraulic sweeper attachments.



SmartSweep®

HydroSweeper

MaxiSweeper

MagneticSweeper

LazySweeper

INTERNAL TRANSPORT EQUIPMENT & WAREHOUSE ACCESSORIES



Discover our complete range of internal transport equipment as well as warehouse and workshop accessories in the 'Attachments & handling equipment' catalogue.

Order your copy using REF 29228025 or download the catalogue via our website: www.tvh.com



TOTAL LIFTER®

Climax

TOTAL SOURCE®



CATALOGUES



Our catalogues give you information about the product groups, brands and makes in our range. The extensive and detailed information contains general product info, pictures, dimensions ...

- REF 21713862 Consumables & accessories
- REF 24369772 Attachments & handling equipment
- REF 25564923 Batteries, chargers & accessories
- REF 20177702 Brushes
- REF 21497415 Bulbs
- REF 15282597 Chains & accessories
- REF 10185471 Contactors & contacts
- REF 21178582 Electronic accessories
- REF 20777844 Energic plus
- REF 20177485 Engine parts
- REF 10727802 Exhaust systems
- REF 29793487 Fluke
- REF 20177906 Fuses & fuse holders
- REF 29127398 Grammer seats
- REF 10550844 Hand pallet truck parts
- REF 31331437 Hydraulic parts & accessories
- REF 19949421 Key switches
- REF 12594102 Labels & decals
- REF 22802499 LPG system parts
- REF 7872482 Mast rollers
- REF 26501928 Paint & accessories
- REF 7835233 Potentiometers & encoders
- REF 7083552 Relays
- REF 12726578 Replacement parts for Genie
- REF 15069637 Replacement parts for Haulotte
- REF 12613028 Replacement parts for JLG
- REF 20769251 Replacement parts for scrubbers & sweepers
- REF 24154086 Replacement parts for tail lifts
- REF 27506014 Seats & accessories
- REF 6252659 Starters & alternators
- REF 22657942 Tracks & undercarriage parts
- REF 24337660 Tyres, rims & accessories
- REF 7072186 Wheel brake & master cylinders
- REF 6781097 Wheels, rollers & castors
- Range of filters available in MyProductSearch & MyPartsFinder

PRODUCT SPECIALS



We gladly keep you informed of our extensive product range. In addition to our catalogues we present you our 'product specials': useful brochures that will guide you within specific product categories.

- REF 27903004 Air conditioning
- REF 17857457 Beta, quality tools & workwear
- REF 14372877 Document & accessories holders
- REF 21735662 Drum handling & accessories
- REF 22835159 Force professional tools
- REF 24010825 Forks & accessories
- REF 21720627 Hardware special
- REF 21713854 Hydraulic power units
- REF 18178749 Jacks & supports
- REF 22775197 LED lights
- REF 21841408 Lubrication & accessories
- REF 20382686 Maintenance special
- REF 20778928 Mirrors
- REF 23942036 Oils & greases
- REF 17868205 Press special
- REF 18666614 Safety & ergonomics special
- REF 24261715 Seats & accessories
- REF 20963014 Skips, scoops & crane jibs
- REF 27693679 Summertime special
- REF 19550195 Twistlocks special
- REF 15372984 Tyres & accessories
- REF 18329658 Weighing special
- REF 21497051 Windshields & glazing
- REF 28809094 Winter products



MYTOTALSOURCE

Visit our webshop
where and when
you want.

Forwarding price inquiries and orders is fast, easy and only one click away. 24/7 available.



Receive your complete offer immediately

Use a TVH or OEM number to get price and availability. Even the reference on the part itself is often recognized in MyTotalSource.

Place your order in just a few clicks

4 easy steps to send your order:

1. Create your order basket
2. Change your order
3. View your order
4. Confirm your order

Search online

- You have **machine or equipment details?**
Use **MyPartsFinder** to find the spare part you need.
- You have the **technical details or specifications of a part?**
Use **MyProductSearch** to find the spare part you need.
- Use our online **catalogues**.
- **Haven't found the reference you were looking for?**
Fill out the technical sheet you can find in MyTotalSource ('Info & Promotions') or in this catalogue.
- **MyTVHLink:** work more efficiently by making an EDI-connection between your company software and TVH

mytotalsource.tvh.com



MyTotalSource app: place orders via your smartphone or table

The MyTotalSource app offers you the possibility to request offers, place orders, manage lists and scan bar codes of references from your smartphone.

How it works:

1. Download the MyTotalSource app, available for Android or iOS.
2. Log on to the mobile MyTotalSource app with your MyTotalSource login details.
3. Discover all the possibilities.

"Scan to order" system.

Scan the bar code with your smartphone or bluetooth scanner and get a price and availability to complete your offer/order.

If you have any questions, call or mail our help desk for free support: **T +32 56 43 48 66 · ecommerce@tvh.com**

Request your login details now and benefit from the many advantages that MyTotalSource offers!



ELECTRONIC PARTS

Our range includes printed circuit boards, electronic speed controllers, displays, chargers, contactors, joysticks, accelerators and directional switches.

Our electronics department is Europe's largest, best equipped and most diverse service centre for the repair of electronic parts for forklifts, aerial work platforms and industrial vehicles.



Find out more about our electronics department in our brochure (REF 20207048) or go to downloads on www.tvh.com to watch the movie.



RECONDITIONED PARTS

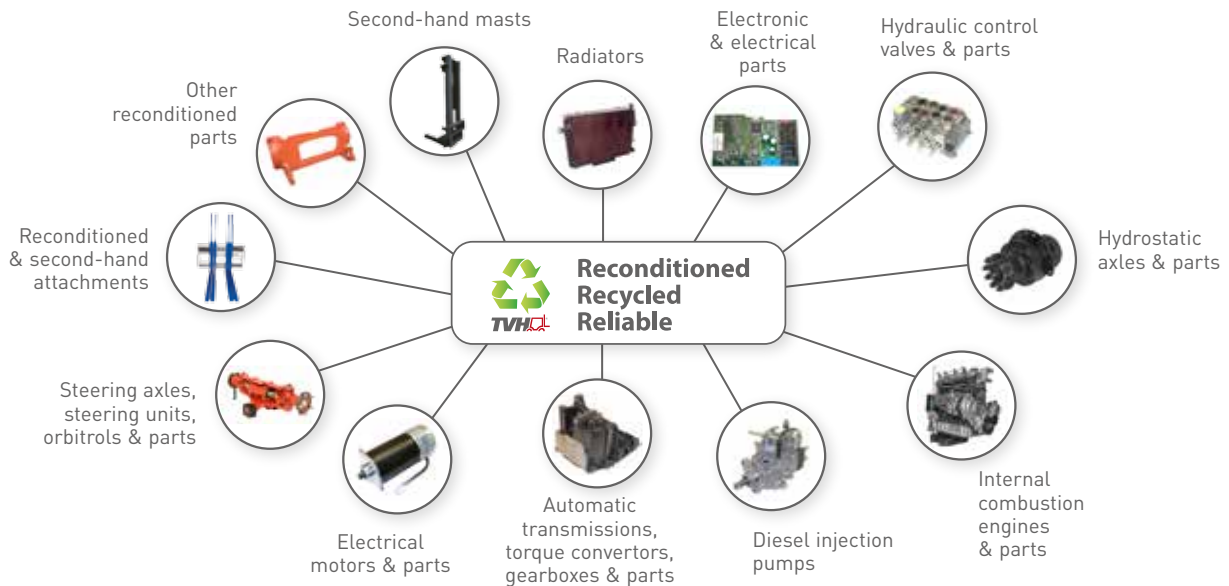

We offer you a unique range of reconditioned parts, at the best price. Reconditioned parts are sold with the same warranty as for a new part, at a price that can be up to 50% cheaper!

Electric motors, internal combustion engines, print-boards, hydraulic pumps, transmissions, torque converters, radiators, steering axles, starters, alternators ... everything is in stock! TVH has invested in a wide range of test devices which allow us to pass stringent quality controls on various spare parts. The tests are designed in such a manner that a realistic work situation is generated during the tests.

Buying one of our reconditioned parts is the perfect alternative to buying a new spare part. Ask for the availability and the conditions! You can buy a reconditioned part with or without the return of an old unit (service exchange parts).



Find out more about our reconditioned parts in our brochure (REF 29127412) or go to downloads on www.tvh.com to watch the movie.



TVH-BAY



TVH's online outlet shop with more than 1000 new and second-hand products at rock-bottom prices! Available in 16 languages.

The online shop to pick up real bargains

- Rock-bottom prices for a limited offer of hard-to-find parts and accessories
- A list of products per brand or product category
- A wide range of parts and accessories for lift trucks, handling equipment and related products
- All parts are available off the shelf, and can therefore be delivered quickly
- Frequently updated with new references

Go to www.tvh.com/tvhbay

SECOND-HAND ATTACHMENTS



More than 500 products in stock

TVH likes to invest in durability and pursues this as much as possible in its products. The range of second-hand attachments in original or completely revised condition is very extensive and varied: rotators, fork positioners, carpet booms, bale clamps, paper roll clamps ...

We have second-hand attachments in our range for Bolzoni, CAM System, Cascade, Kaup, Kooi, Meyer ...

Discover our full range on www.tvh.com/tvhbay



SECOND-HAND EQUIPMENT



- Specialist in lift trucks and aerial work platforms with a permanent stock of 1500 lift trucks and 250 aerial work platforms
- Telehandlers and all-terrain trucks
- Masts and attachments

Find a daily updated stock list on our search engine
myequipmentfinder.tvh.com



ELECTRIC WAREHOUSING

Electric pallet trucks (from 1,5-2 t)
 and stackers (from 1-1,6 t)



Brochure
 Climax
REF 27617387

Climax

www.climaxhandling.com

info@climaxhandling.com · T +32 56 43 41 19





About TVH	I
· TVH History.....	I
· Parts & Accessories.....	II
· Attachments & handling equipment.....	III
· Catalogues & product specials.....	IV
· Webshop & online support.....	V
· Electronic & reconditioned parts.....	VI
· TVH-bay & second-hand attachments.....	VII
· TVH Equipment.....	VIII

Table of contents	A
· English.....	A
· Nederlands.....	B
· Français.....	C
· Deutsch.....	D
· Español.....	E
· Italiano.....	F
· Português.....	G
· Polski.....	H
· Русский.....	I
· Complete range.....	J

Nice to know	1
· Nice to know.....	2

Seats	11
· TOTALSOURCE.....	13
· GRAMMER.....	61
· KAB.....	87
· ISRI.....	127
· SEARS.....	139
· KLEPP.....	143
· COBO.....	147
· BE-GE.....	157
· MILSCO.....	167
· Anti-static seats.....	173
· Heated seats.....	175
· Narrow seats.....	179
· Seats for specific makes.....	183

Accessories	185
· Static seat belt.....	186
· ALR seat belt.....	187
· ELR seat belt.....	191
· MUR seat belt.....	195
· 3-Point seat belt.....	196
· Seat belt extender.....	197
· EZE belt.....	198
· Springbelt.....	199
· Universal seat belt bracket.....	200
· Seat belt bracket.....	200

· Seat cover.....	200
· Disposable seat cover.....	200
· Seat cover Grammer.....	201
· Summer seat.....	201
· Universal seat heating.....	201
· Seat heating.....	202
· Operator presence switch.....	202
· Seat switch.....	202
· Document holder.....	203
· Document net.....	203
· Twiggy seal to secure document holders.....	204
· Sticker.....	204
· Universal turntable.....	205
· Grammer turntable.....	205
· Fastened seat belt indicator.....	205

Consumables	207
· Multi-organizer console.....	208
· Mag-kaddy.....	208
· Solar cap.....	209
· Canopies.....	209
· PVC weatheguard.....	209
· Sunscreen.....	209
· 17 Piece 1/2" hexagon combination set.....	210
· 19 Piece 1/2" socket and accessories set – metric.....	210
· 24 Piece 1/2" sockets and accessories set – inch.....	210
· 8 Piece 'betagrip' screwdriver set.....	211
· 6 Piece slotted and phillips antislip bi-component handle screwdriver set.....	211
· Dry lube.....	212
· 5-56 + Ptfе universal oil spray.....	212
· Glass clean.....	212
· Textile cleaner.....	212
· Leather conditioner.....	213
· Insect cleaner.....	213
· De-icer.....	213
· Cockpit spray.....	213
· Sponge.....	214
· Synthetic shammy.....	214
· Reusable gloves for chemical industry.....	214
· Flexidyn pu.....	215
· Perfect fit glove polytril air comfort.....	215

Technical sheets	217
· Technical sheets.....	218



Over TVH	I
· TVH-geschiedenis.....	I
· Onderdelen & accessoires.....	II
· Voorzetapparatuur & handling equipment.....	III
· Catalogen & product specials.....	IV
· Webshop & online ondersteuning.....	V
· Elektronische & gereconditioneerde onderdelen.....	VI
· TVH-bay/Tweedehandse voorzetapparatuur.....	VII
· TVH Equipment.....	VIII

Inhoudsopgave	A
· English.....	A
· Nederlands.....	B
· Français.....	C
· Deutsch.....	D
· Español.....	E
· Italiano.....	F
· Português.....	G
· Polski.....	H
· Русский.....	I
· Volledig gamma.....	J

Goed om weten	1
· Goed om weten.....	2

Zetels	11
· TOTALSOURCE.....	13
· GRAMMER.....	61
· KAB.....	87
· ISRI.....	127
· SEARS.....	139
· KLEPP.....	143
· COBO.....	147
· BE-GE.....	157
· MILSCO.....	167
· Antistatische zetels.....	173
· Verwarmde zetels.....	175
· Smalle zetels.....	179
· Zetels voor specifieke merken.....	183

Accessoires	185
· Statische veiligheidsgordel.....	186
· ALR-gordel.....	187
· ELR-gordel.....	191
· MUR-gordel.....	195
· 3-puntsgordel.....	196
· Gordel verlengstuk.....	197
· EZE-gordel.....	198
· Springbelt.....	199
· Universele montagebeugel.....	200
· Montagebeugel.....	200

· Zetelovertrek.....	200
· Wegwerp zetelovertrek.....	200
· Zetelovertrek Grammer.....	201
· Zomerzetelovertrek.....	201
· Universele zetelverwarming.....	201
· Zetelverwarming.....	202
· Dodemansschakelaar.....	202
· Zetelschakelaar.....	202
· Documenthouder.....	203
· Documentnet.....	203
· Rijgsnoer voor het beveiligen van documenthouders.....	204
· Sticker.....	204
· Universeel draaiplateau.....	205
· Grammer draaiplateau.....	205
· Bevestigde gordelindicator.....	205

Verbruiksgoederen..... **207**

· Multi-organizer.....	208
· Mag-Kaddy.....	208
· Dakpaneel.....	209
· Dakbescherming.....	209
· Weersbestendige PVC dakbescherming.....	209
· Zonnescherm.....	209
· 17-delige 1/2" zeskant combinatieset.....	210
· 19-delige 1/2" dopsleutel- en accessoireset - metrisch.....	210
· 24-delige 1/2" dopsleutel- en accessoireset - inch.....	210
· 8-delige BetaGRIP schroevendraaierset.....	211
· 6-delige platte en Phillips antislip bi-component handvat schroevendraaierset.....	211
· Droog smeermiddel.....	212
· 5-56+ PTFE universele oliespray.....	212
· Glasreiniger.....	212
· Textielreiniger.....	212
· Verzorgingsmiddel leder.....	213
· Insectenreiniger.....	213
· Ontdooier.....	213
· Cockpitspray.....	213
· Spons.....	214
· Synthetisch zeemvel.....	214
· Herbruikbare handschoenen voor de chemische industrie.....	214
· Flexidyn PU.....	215
· Handschoen Polytril Air Comfort perfecte pasvorm.....	215

Technische fiches..... **217**

· Technische fiches.....	218
--------------------------	-----



À propos de TVH	I
· Histoire TVH.....	I
· Pièces & accessoires.....	II
· Accessoires & matériel de magasinage.....	III
· Catalogues & product specials.....	IV
· Magasin & support en ligne.....	V
· Pièces électroniques & remises à neuf.....	VI
· TVH-bay / Accessoires d'occasion.....	VII
· TVH Equipment.....	VIII

Table des matières	A
· English.....	A
· Nederlands.....	B
· Français.....	C
· Deutsch.....	D
· Español.....	E
· Italiano.....	F
· Portuguais.....	G
· Polski.....	H
· Русский.....	I
· Gamme complète.....	J

Bon à savoir	1
· Bon à savoir.....	2

Sièges	11
· TOTALSOURCE.....	13
· GRAMMER.....	61
· KAB.....	87
· ISRI.....	127
· SEARS.....	139
· KLEPP.....	143
· COBO.....	147
· BE-GE.....	157
· MILSCO.....	167
· Sièges antistatiques.....	173
· Sièges chauffants.....	175
· Sièges étroits.....	179
· Sièges pour marques spécifiques.....	183

Accessoires	185
· Ceinture de sécurité statique.....	186
· Ceinture de sécurité ALR.....	187
· Ceinture de sécurité ELR.....	191
· Ceinture de sécurité MUR.....	195
· Ceinture de sécurité à 3 points.....	196
· Rallonge de ceinture.....	197
· Ceinture EZE.....	198
· Springbelt.....	199
· Support universel pour ceinture de sécurité.....	200
· Support pour ceinture de sécurité.....	200

· Housse de siège.....	200
· Housse de siège jetable.....	200
· Housse de siège Grammer.....	201
· Housse de siège d'été.....	201
· Chauffage de siège universel.....	201
· Chauffage de siège.....	202
· Contacteur de présence opérateur.....	202
· Contact de siège.....	202
· Porte-documents.....	203
· Filet pour documents.....	203
· Scellé plastique pour porte-documents.....	204
· Autocollant.....	204
· Embase pivotante universelle.....	205
· Embase pivotante Grammer.....	205
· Indicateur de ceinture de sécurité attachée.....	205

Consommables	207
· Console multifonction.....	208
· Mag-Kaddy.....	208
· Couverture pare-soleil.....	209
· Toit de protection.....	209
· Protège-pluie PVC.....	209
· Pare-soleil.....	209
· Jeu de 17 pièces 1/2" à six pans.....	210
· Jeu de 19 douilles et accessoires 1/2" - métrique.....	210
· Jeu de 24 douilles et accessoires 1/2" - pouces.....	210
· Jeu de 8 tournevis 'BetaGRIP'.....	211
· Jeu de 6 tournevis plats et cruciformes Phillips, à poignée antidérapante bi-matière.....	211
· Lubrifiant sec.....	212
· Huile universelle téflon en spray 5-56.....	212
· Nettoyant vitres.....	212
· Nettoyant textile.....	212
· Baume pour cuir.....	213
· Spray anti-insectes.....	213
· Dégivrant.....	213
· Nettoyant habitacle.....	213
· Éponge.....	214
· Peau de chamois synthétique.....	214
· Gants réutilisables pour industrie chimique.....	214
· Flexidyn polyuréthane.....	215
· Gants moulants Polytril Air Comfort.....	215

Fiches techniques	217
· Fiches techniques.....	218



Über TVH	I
· TVH Geschichte	I
· Ersatzteile & Zubehör	II
· Anbaugeräte & Flurförderzeuge	III
· Kataloge & Product Specials	IV
· Webshop & Online-Unterstützung	V
· Elektronik- & Gebrauchte Teile	VI
· TVH-bay/Gebrauchte Anbaugeräte	VII
· TVH Equipment	VIII

Inhaltverzeichnis	A
· English	A
· Nederlands	B
· Français	C
· Deutsch	D
· Español	E
· Italiano	F
· Português	G
· Polski	H
· Русский	I
· Komplettes Sortiment	J

Gut zu wissen	1
· Gut zu wissen	2

Sitze	11
· TOTALSOURCE	13
· GRAMMER	61
· KAB	87
· ISRI	127
· SEARS	139
· KLEPP	143
· COBO	147
· BE-GE	157
· MILSCO	167
· Antistatische Sitze	173
· Geheizte Sitze	175
· Schmale Sitze	179
· Sitze für bestimmte Marken	183

Zubehör	185
· Statik-Sicherheitsgurt	186
· ALR-Sicherheitsgurt	187
· ELR-Sicherheitsgurt	191
· MUR-Sicherheitsgurt	195
· Dreipunkt-Sicherheitsgurt	196
· Sicherheitsgurtverlängerung	197
· EZE-Sicherheitsgurt	198
· Springbelt	199
· Universal Sicherheitsgurt Klammer	200
· Sicherheitsgurt Klammer	200

· Sitzbezug	200
· Einweg-Sitzbezug	200
· Sitzbezug Grammer	201
· Sommersitzbezug	201
· Universal Sitzheizung	201
· Sitzheizung	202
· Totmannschalter	202
· Sitzschalter	202
· Dokumentenhalter	203
· Dokumentennetz	203
· Twiggly Dichtung für Dokumentenhalter	204
· Aufkleber	204
· Universaler Drehteller	205
· Grammer Drehteller	205
· Gurtwarner	205

Verbrauchsmaterialien	207
· Multi-Organizer Konsole	208
· Mag-Kaddy (magnetischer Halter)	208
· Sonnenblende	209
· Überdachung	209
· PVC Wetterschutzdach	209
· Sonnenblende	209
· 17-teilige Set mit 1/2" Sechskant Steckschlüsselsatz	210
· 24-teilige Set mit 1/2" Stecknüssen und Zubehör - metrisch	210
· 24-teilige Set mit 1/2" Stecknüssen und Zubehör - Zoll	210
· 8-teilige BetaGRIP-Schraubendrehersatz	211
· 6-teilige Set Schlitz- und Phillips-Schraubendreher mit rutschfestem Zweikomponentengriff	211
· Trockenschmierstoff	212
· 5-56 + PTFE Universalölspray	212
· Scheibenreiniger	212
· Textilpfleger	212
· Lederpflege	213
· Insektenreiniger	213
· Enteiserspray	213
· Cockpit-Spray	213
· Schwamm	214
· Kunstledertuch	214
· Wiederverwendbare Handschuhe für die chemische Industrie	214
· Flexidyn PU	215
· Handschuh perfekte Passform, polytril Klimakomfort	215

Technische Datenblätter	217
· Technische Datenblätter	218



Sobre TVH	I
· Historia de TVH.....	I
· Recambios & accesorios.....	II
· Implementos & equipamiento de manipulación de interiores.....	III
· Catálogos & folletos de producto.....	IV
· Tienda & asistencia online.....	V
· Recambios electrónicos & reacondicionados.....	VI
· TVH-bay/Implementos de segunda mano.....	VII
· TVH Equipment.....	VIII

Índice	A
· English.....	A
· Nederlands.....	B
· Français.....	C
· Deutsch.....	D
· Español.....	E
· Italiano.....	F
· Português.....	G
· Polski.....	H
· Русский.....	I
· Gama completa.....	J

Sabía que	1
· Sabía que.....	2

Asientos	11
· TOTALSOURCE.....	13
· GRAMMER.....	61
· KAB.....	87
· ISRI.....	127
· SEARS.....	139
· KLEPP.....	143
· COBO.....	147
· BE-GE.....	157
· MILSCO.....	167
· Asientos antiestáticos.....	173
· Asientos con calefacción.....	175
· Asientos estrechos.....	179
· Asientos para marcas específicas.....	183

Accesorios	185
· Cinturón de seguridad estático.....	186
· Cinturón de seguridad ALR.....	187
· Cinturón de seguridad ELR.....	191
· Cinturón de seguridad Mur.....	195
· Cinturón de seguridad de 3 puntos.....	196
· Extensor de cinturón.....	197
· Cinturón EZE.....	198
· Springbelt.....	199
· Soporte universal de cinturón de seguridad.....	200

· Soporte de cinturón de seguridad.....	200
· Cubre asiento.....	200
· Cubre asiento desechable.....	200
· Cubre asiento Grammer.....	201
· Cubierta de asiento de verano.....	201
· Calefacción de asientos universal.....	201
· Calefacción de asientos.....	202
· Interruptor (OPS).....	202
· Interruptor del asiento.....	202
· Portadocumentos.....	203
· Malla para documentación.....	203
· Precintos de brida para fijar portadocumentos.....	204
· Pegatina.....	204
· Placa giratoria universal.....	205
· Placa giratoria Grammer.....	205
· Indicador de cinturón abrochado.....	205

Consumibles	207
· Caja multi organizadora.....	208
· Mag-Kaddy.....	208
· Protector solar.....	209
· Cubiertas de cabina.....	209
· Cubierta de cabina PVC.....	209
· Protector contra los rayos del sol.....	209
· Juego con 17 llaves fijas hexagonales 1/2".....	210
· Juego con 19 tornillos y accesorios 1/2" - métrico.....	210
· Juego con 24 tornillos y accesorios 1/2" - inch.....	210
· Juego con 8 destornilladores BetaGRIP.....	211
· Juego con 6 destornilladores bi-componentes con mango antideslizante planos y Philips.....	211
· Lubricante seco.....	212
· Aceite universal en spray 5-56+ PTFE.....	212
· Limpiacristales.....	212
· Limpiador textil.....	212
· Acondicionador de cuero.....	213
· Insecticida.....	213
· Descongelador.....	213
· Spray para cabina.....	213
· Esponja.....	214
· Piel de gamuza sintético.....	214
· Guantes reutilizables para la industria química.....	214
· Guantes flexidyn PU.....	215
· Guantes segunda piel Polytril Air Comfort.....	215

Hojas técnicas	217
· Hojas técnicas.....	218



Circa TVH	I
· Storia TVH	I
· Ricambi & accessori	II
· Attrezzature & handling equipment	III
· Cataloghi & speciale prodotti	IV
· Webshop & assistenza online	V
· Elettronica & ricambi ricondizionati	VI
· TVH-bay/Accessori d'occasione	VII
· TVH Equipment	VIII

Tabella dei contenuti	A
· English	A
· Nederlands	B
· Français	C
· Deutsch	D
· Español	E
· Italiano	F
· Português	G
· Polski	H
· Русский	I
· Gamma completa	J

Utile da sapere	1
· Utile da sapere	2

Sedili	11
· TOTALSOURCE	13
· GRAMMER	61
· KAB	87
· ISRI	127
· SEARS	139
· KLEPP	143
· COBO	147
· BE-GE	157
· MILSCO	167
· Sedili anti-statici	173
· Sedili riscaldati	175
· Sedili stretti	179
· Sedili per marchi specifici	183

Accessori	185
· Cintura statica	186
· Cintura ALR	187
· Cintura ELR	191
· Cintura MUR	195
· Cintura 3-punti	196
· Estensore cintura	197
· Cintura EZE	198
· Springbelt	199
· Staffa universale cintura	200
· Staffa per cintura di sicurezza	200

· Coprisedile	200
· Coprisedile monouso	200
· Coprisedile per Grammer	201
· Protezione estiva sedile	201
· Riscalda sedile universale	201
· Riscalda sedile	202
· Sensore uomo a bordo	202
· Microswitch per sedile	202
· Porta documenti	203
· Porta documenti rete	203
· Clip ferma documenti	204
· Adesivo	204
· Tavolo girevole universale	205
· Tavolo girevole Grammer	205
· Fermo per indicatore cintura	205

Consumabili	207
· Console multi-funzione	208
· Cassetta porta-attrezzi (Mag-Kaddy)	208
· Protezione solare	209
· Parasole	209
· Parapioggia in PVC	209
· Parasole	209
· Set da 17 pezzi 1/2" esagonale	210
· Set da 19 pezzi 1/2" bulloni più accessori - metrico	210
· Set da 24 pezzi 1/2" bulloni più accessori - pollici	210
· Set da 8 cacciaviti BetaGRIP	211
· Set da 6 cacciaviti antiscivolo con intaglio tipo Phillips	211
· Lubrificante secco	212
· Olio spray universale 5-56 + PTFE	212
· Lavavetri	212
· Pulitore specifico per i tessuti	212
· Ammorbidente pelle	213
· Pulisci insetti	213
· Anti-gelo	213
· Spray per cabina	213
· Spugna	214
· Camoscio sintetico	214
· Guanti pluriuso	214
· Flexidyn PU	215
· Guanti Polytril Air Comfort	215

Schede tecniche	217
· Schede tecniche	218



Sobre a TVH	I
· História da TVH.....	I
· Peças & acessórios.....	II
· Acessórios & equipamento handling.....	III
· Catálogos & folhetos de produtos.....	IV
· Loja & apoio online.....	V
· Peças eletrônicas & reconcionadas.....	VI
· TVH-bay/Acessórios de segunda mão.....	VII
· TVH Equipment.....	VIII

Índice	A
· English.....	A
· Nederlands.....	B
· Français.....	C
· Deutsch.....	D
· Español.....	E
· Italiano.....	F
· Português.....	G
· Polski.....	H
· Русский.....	I
· Gama completa.....	J

Bom saber	1
· Bom saber.....	2

Bancos	11
· TOTALSOURCE.....	13
· GRAMMER.....	61
· KAB.....	87
· ISRI.....	127
· SEARS.....	139
· KLEPP.....	143
· COBO.....	147
· BE-GE.....	157
· MILSCO.....	167
· Bancos anti-estáticos.....	173
· Bancos aquecidos.....	175
· Bancos estreitos.....	179
· Bancos para marcas específicas.....	183

Acessórios	185
· Cinto de segurança estático.....	186
· Cinto de segurança ALR.....	187
· Cinto de segurança ELR.....	191
· Cinto de segurança MUR.....	195
· Cinto de segurança de 3 pontos.....	196
· Extensor de cinto de segurança.....	197
· Cinto EZE.....	198
· Springbelt.....	199
· Suporte universal para cinto de segurança.....	200
· Suporte para cinto de segurança.....	200

· Forro para banco.....	200
· Forro descartável para banco.....	200
· Forro para banco Grammer.....	201
· Banco de verão.....	201
· Aquecedor universal para banco.....	201
· Aquecedor para banco.....	202
· Interruptor de presença do operador.....	202
· Interruptor de banco.....	202
· Porta documentos.....	203
· Rede para documentos.....	203
· Vedante ramoso para proteger documentos.....	204
· Adesivo.....	204
· Placa giratória universal.....	205
· Placa giratória Grammer.....	205
· Indicador de cinto de segurança apertado.....	205

Consumíveis	207
· Consola multi organizatória.....	208
· Mag-Kaddy.....	208
· Capa solar.....	209
· Resguardos.....	209
· Lona de proteção PVC.....	209
· Protetor solar.....	209
· Kit de combinação 17 peças 1/2".....	210
· Jogo de brocas e acessórios - 19 peças 1/2" - métrico.....	210
· Jogo de brocas e acessórios - 24 peças 1/2" - polegadas.....	210
· Jogo de chaves de fenda BetaGRIP - 8 peças.....	211
· Jogo de chaves de fenda Phillips antiskid bi-componente - 6 peças.....	211
· Lubrificante seco.....	212
· Spray de óleo universal 5-56 + PTFE.....	212
· Limpa vidro.....	212
· Limpa textil.....	212
· Condicionador de couro.....	213
· Limpa insetos.....	213
· Anticongelante.....	213
· Spray para cabine.....	213
· Esponja.....	214
· Camurça sintética.....	214
· Luvas reutilizáveis para a indústria química.....	214
· Flexidyn PU.....	215
· Luvas Polytril Air Comfort - ajuste perfeito.....	215

Technical sheets	217
· Fichas técnicas.....	218



Informacje o TVH	I
· Historia TVH	I
· Części & akcesoriów	II
· Osprzęt do wózków widłowych & sprzęt magazynowy	III
· Katalogi & produkty specjalne	IV
· Sklep internetowy & wsparcie on-line	V
· Części elektroniczne & regenerowane	VI
· TVH-bay/Używany osprzęt do wózków	VII
· TVH Equipment	VIII

Spis treści	A
· English	A
· Nederlands	B
· Français	C
· Deutsch	D
· Español	E
· Italiano	F
· Português	G
· Polski	H
· Русский	I
· Pełna gama	J

Warto wiedzieć	1
· Warto wiedzieć	2

Fotele	11
· TOTALSOURCE	13
· GRAMMER	61
· KAB	87
· ISRI	127
· SEARS	139
· KLEPP	143
· COBO	147
· BE-GE	157
· MILSCO	167
· Fotele antystatyczne	173
· Podgrzewane fotele	175
· Wąskie fotele	179
· Fotele do specyficznych marek	183

Akcesoria	185
· Statyczne pasy bezpieczeństwa	186
· Pasy bezpieczeństwa ALR	187
· Pasy bezpieczeństwa ELR	191
· Pasy bezpieczeństwa MUR	195
· 3-punktowe pasy bezpieczeństwa	196
· Przedłużka do pasa bezpieczeństwa	197
· Pas EZE	198
· Springbelt	199
· Uniwersalny uchwyt do pasa bezpieczeństwa	200
· Uchwyt do pasa bezpieczeństwa	200

· Pokrowiec na fotel	200
· Jednorazowy pokrowiec na fotel	200
· Pokrowiec na fotel Grammer	201
· Fotel letni	201
· Uniwersalne ogrzewanie do fotela	201
· Ogrzewanie fotela	202
· Czujnik obecności operatora	202
· Czujnik fotela	202
· Etui na dokumenty	203
· Siatka na dokumenty	203
· Plomba plastikowa	204
· Naklejki	204
· Uniwersalna podstawa obrotowa	205
· Podstawa obrotowa Grammer	205
· Wskaźnik zapięcia pasów bezpieczeństwa	205

Produkty eksploatacyjne	207
· Organizer	208
· Mag-Kaddy	208
· Osłona przeciwstoneczna	209
· Dachy	209
· Osłona PCV	209
· Osłona przeciwstoneczna	209
· 17-częściowy zestaw kluczy 1/2" sześciokątnych	210
· 19-częściowy zestaw nasadek i akcesoriów 1/2" – metryczne	210
· 24-częściowy zestaw nasadek i akcesoriów 1/2" – calowe	210
· 8-częściowy zestaw wkrętałów BetaGRIP	211
· 6-częściowy zestaw wkrętałów płaskich i typu Phillips z antypoślizgowym chwytem	211
· Szybkoschnący środek smarujący	212
· 5-56+ PTFE uniwersalny olej w aerozolu	212
· Płyn do czyszczenia szyb	212
· Płyn czyszczący do tkanin tekstylnych	212
· Płyn czyszczący do skór	213
· Płyn do usuwania insektów	213
· Płyn odmrażający	213
· Aerosol do deski rozdzielczej	213
· Gąbka	214
· Zamsz syntetyczny	214
· Rękawice dla przemysłu chemicznego	214
· Flexidyn PU	215
· Rękawiczki Polytril Air Comfort	215

Formularze techniczne	217
· Formularze techniczne	218



Кратко о TVH	I
· История TVH.....	I
· Запчасти & аксессуары.....	II
· Навесное и складское оборудование.....	III
· Каталоги и ассортиментные подборки.....	IV
· Вебшоп и сетевая поддержка.....	V
· Электронные и восстановленные узлы.....	VI
· TVH-bay/Навесное оборудование б/у.....	VII
· TVH Equipment.....	VIII

Оглавление	A
· English.....	A
· Nederlands.....	B
· Français.....	C
· Deutsch.....	D
· Español.....	E
· Italiano.....	F
· Português.....	G
· Polski.....	H
· Русский.....	I
· Полный ассортимент.....	J

Полезно знать	1
· Полезно знать.....	2

Сиденья	11
· TOTALSOURCE.....	13
· GRAMMER.....	61
· KAB.....	87
· ISRI.....	127
· SEARS.....	139
· KLEPP.....	143
· COBO.....	147
· BE-GE.....	157
· MILSCO.....	167
· Антистатические сиденья.....	173
· Сиденья с подогревом.....	175
· Узкие сиденья.....	179
· Сиденья для специализированных брендов.....	183

Аксессуары	185
· Статичные ремни безопасности.....	186
· Ремни безопасности с автоматическим натяжением.....	187
· Ремни безопасности с аварийной блокировкой.....	191
· Ремни безопасности Mip.....	195
· Ремни безопасности с трехточечным креплением.....	196
· Удлинитель ремня безопасности.....	197
· Ремень EZE.....	198
· Springbelt.....	199
· Универсальный кронштейн для ремня безопасности.....	200
· Кронштейн для ремня безопасности.....	200

· Покрытие для сиденья.....	200
· Покрытие для сиденья выбрасываемое.....	200
· Покрытие для сиденья Grammer.....	201
· Сиденье летнее.....	201
· Универсальный обогреватель сиденья.....	201
· Обогреватель сиденья.....	202
· Сенсор присутствия водителя.....	202
· Переключатель сиденья.....	202
· Держатель документа.....	203
· Сетка для документов.....	203
· Пломба для фиксации держателей документов.....	204
· Наклейка.....	204
· Универсальная вертушка.....	205
· Вертушка Grammer.....	205
· Индикатор фиксации ремня безопасности.....	205

Расходные материалы	207
· Мульти-органайзер.....	208
· Контейнер Mag-Kaddy.....	208
· Солнечный козырек.....	209
· Навесы.....	209
· Защита от непогоды ПВХ.....	209
· Солнцезащитный экран.....	209
· Комбинированный комплект из 17 торцовых ключей 1/2".....	210
· Комплект из 19 ударных головок и аксессуаров 1/2" – метр.....	210
· Комплект из 24 ударных головок и аксессуаров 1/2" – дюйм.....	210
· Комплект из 8 отверток BetaGRIP.....	211
· Комплект из 6 ручных шлицевых и крестовых двухкомпонентных отверток с противоскольжением.....	211
· Сухая смазка.....	212
· Универсальный масляный аэрозоль 5-56+ PTFE.....	212
· Очиститель для стекла.....	212
· Очиститель для текстиля.....	212
· Кондиционер для кожаных изделий.....	213
· Очиститель от насекомых.....	213
· Противообледенитель.....	213
· Аэрозоль для кабины.....	213
· Губка.....	214
· Синтетическая замша.....	214
· Перчатки для работы с реактивами многоразового применения.....	214
· Flexidyn PU.....	215
· Перчатки с удобной посадкой Polytril Air Comfort.....	215

Технические шаблоны	217
· Технические шаблоны.....	218

TABLE OF CONTENTS



COMPLETE RANGE



TABLE OF CONTENTS



COMPLETE RANGE

page 30



TOTALSOURCE

page 31



TOTALSOURCE

page 32



TOTALSOURCE

page 33



TOTALSOURCE

page 34



TOTALSOURCE

page 35



TOTALSOURCE

page 36



TOTALSOURCE

page 37



TOTALSOURCE

page 38



TOTALSOURCE

page 39



TOTALSOURCE

page 40



TOTALSOURCE

page 41



TOTALSOURCE

page 42



TOTALSOURCE

page 43



TOTALSOURCE

page 44



TOTALSOURCE

page 45



TOTALSOURCE

TABLE OF CONTENTS



COMPLETE RANGE

page 46



TOTALSOURCE

page 47



TOTALSOURCE

page 48



TOTALSOURCE

page 49



TOTALSOURCE

page 50



TOTALSOURCE

page 51



TOTALSOURCE

page 52



TOTALSOURCE

page 53



TOTALSOURCE

page 54



TOTALSOURCE

page 55



TOTALSOURCE

page 56



TOTALSOURCE

page 57



TOTALSOURCE

page 58



TOTALSOURCE

page 59



TOTALSOURCE

page 60



TOTALSOURCE

page 62



GRAMMER

TABLE OF CONTENTS



COMPLETE RANGE

page 63



GRAMMER

page 64



GRAMMER

page 65



GRAMMER

page 66



GRAMMER

page 67



GRAMMER

page 68



GRAMMER

page 69



GRAMMER

page 70



GRAMMER

page 71



GRAMMER

page 72



GRAMMER

page 73



GRAMMER

page 74



GRAMMER

page 75



GRAMMER

page 76



GRAMMER

page 77



GRAMMER

page 78



GRAMMER

TABLE OF CONTENTS



COMPLETE RANGE



TABLE OF CONTENTS



COMPLETE RANGE

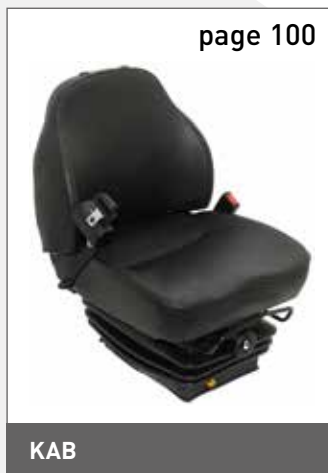

TABLE OF CONTENTS



COMPLETE RANGE



TABLE OF CONTENTS



COMPLETE RANGE

page 130



ISRI

page 131



ISRI

page 132



ISRI

page 133



ISRI

page 134



ISRI

page 135



ISRI

page 136



ISRI

page 137



ISRI

page 140



SEARS

page 141



SEARS

page 142



SEARS

page 144



KLEPP

page 145



KLEPP

page 146



KLEPP

page 148



COBO

page 149



COBO

TABLE OF CONTENTS



COMPLETE RANGE

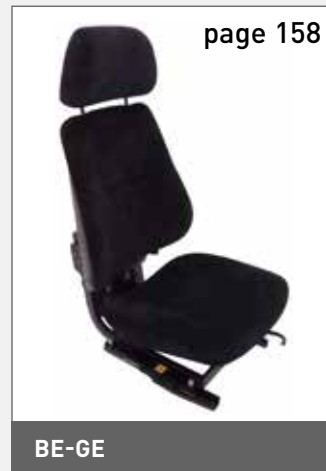



page 169



MILSCO

page 170



MILSCO

page 171



MILSCO

COMPLETE RANGE



NOTES

NOTES

A large area for notes, featuring a light gray background with a white curved shape at the bottom. The area is filled with horizontal dotted lines for writing.



1

NICE TO
KNOW



NICE TO KNOW

Seats

- **Switch (OPS):**

Operator Presence Switch

- **Seat ergonomics:**

One of the most important aspects to consider when buying a seat is the ergonomics. After all, replacing an employee due to physical problems is much harder and more expensive than replacing a seat.

One simple rule to keep in mind if you want to preserve the ergonomics of the original machine, is to replace the broken seat with a 100% equivalent aftermarket alternative. If this is not possible due to unavailability or price, TVH can provide a seat that offers equal economic advantages either via MyPartsFinder or via other media.

One of the most important features is the seat height (seating position). If a seat is too high it will be uncomfortable, too low is hardly even a problem, so we recommend you a seat that has approximately the same sitting height as your old seat.



Old and new fabric



- New Fabric: Blue/black matrix fabric (1) (MH)
- New fabric: Yellow – black (2) (CE)
- Old fabric: Black/grey matrix fabric (3) (CE)





NICE TO KNOW

- **Not available:** this seat can't be sourced and isn't available (anywhere)
- **On request:** if explicitly requested, we can assemble this part for you
- **NLA:** No longer available

- **General REF:** this reference is suitable for both the PVC and the Fabric version of the seat.

Seat belts

- **ALR seat belt:**

Automatic Locking Retractors lock when the lap belt is put around the wearer.

ECE R16 technical definition:

A retractor allowing extraction of the strap to the desired length and which, when the buckle is fastened, automatically adjusts the strap to the wearer. Further extraction of the strap is prevented without voluntary intervention by the wearer.

- **MUR seat belt:**

Manual Unlocking Retractors unlock when the lever is operated.
When in use, this acts as a static seat belt.

- **ELR seat belt:**

Emergency Locking Retractors lock in case of:

- a) webbing acceleration: retractor will lock if the webbing is snatched (Typically abrupt torso movement)
- b) vehicle movement: retractor will lock with sudden vehicle movement (Typically abrupt stopping, vibration or roll-over)



Must be mounted correctly in order to function

c) **ECE R16 technical definition:**

A retractor which - during normal driving conditions - does not restrict the freedom of movement by the wearer of the safety-belt. Such a device has length adjusting components which automatically adjust the strap to the wearer and a locking mechanism actuated in an emergency

*This is only a selection of the seats
and spare parts for seats in our programme.
Please contact us for more information.*



NICE TO KNOW

MyTotalSource

Your interactive online webshop for spare parts



The user-friendly search modules **MyPartsFinder** and **MyProductSearch** allow you to always find the correct part. Alternatively, you can also easily search by partnumber.

1) In **MyPartsFinder** you can find your parts by entering vehicle specifications. (brand, type ...)



2) With **MyProductSearch** you can find your part by entering technical details.

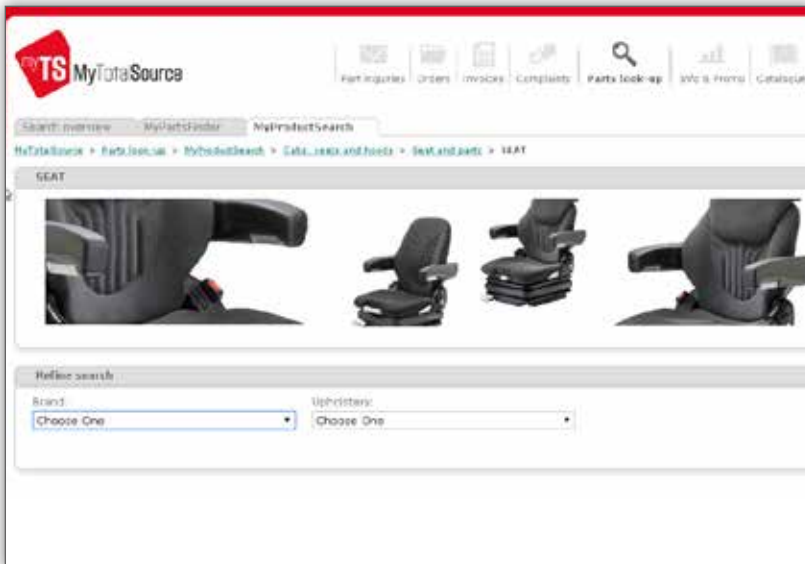

MyProductSearch
Find your consumables group

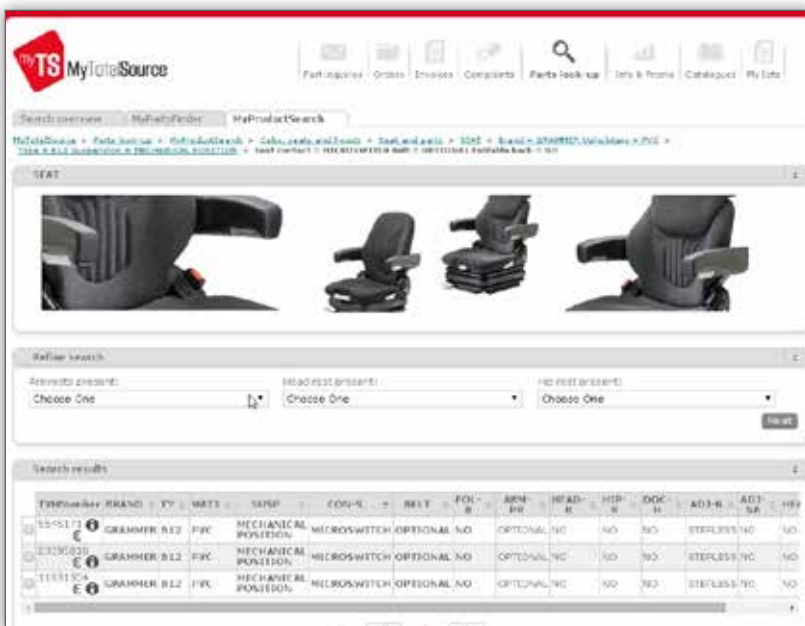

It is also possible to search further via MPS (MyProductSearch) for a similar part with other characteristics if necessary, or the parts can also be compared to each other.



NICE TO KNOW

3) Search by partnumber

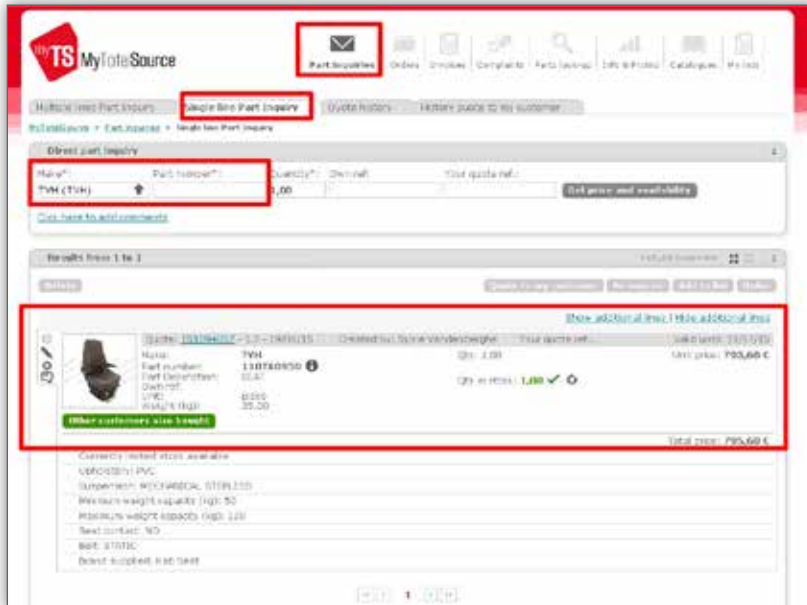

- **Single line part inquiry:** for a quick price and lead time of only 1 item
- **Multiple line part inquiry:** for price and lead time of several parts
- Instant price, availability and picture

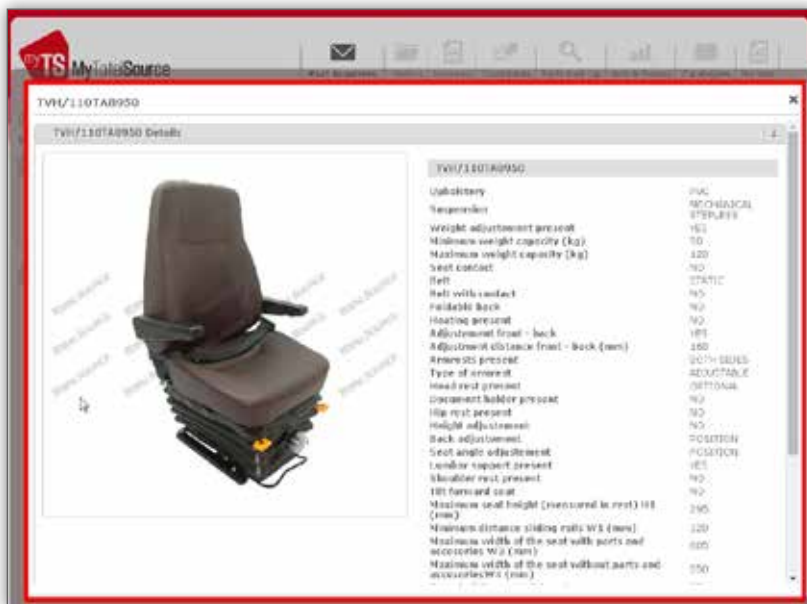

The references in the catalogue only contain the most important info, but once the ref is entered via MTS, then extra info can be consulted such as:

- Extra technical info
- Larger (and more specific) photographs

No login yet? Request your login details now via ecommerce@tvh.com

HELPDESK: T +32 56 43 48 66



NICE TO KNOW

English	Nederlands	Français
air suspension	luchtvering	suspension pneumatique
armrest	armleuning	accoudeoir
backrest adjustment	rugverstelling	réglage du dossier
backrest cover	overtrek rugkussen	housse de dossier
backrest cushion	rugkussen	coussin de dos
depth	diepte	profondeur
document pouch	documentenhouder	porte-documents
fabric	stof	tissu
fixed backrest	vaste rugleuning	dossier fixe
foldable back	vouwbare rug	dossier rabattable
fore/aft adjustment	voor/achter verstelling	réglage avant/arrière
head rest	hoofdsteen	appui-tête
height	hoogte	hauteur
height adjustment	hoogte verstelling	réglage en hauteur
hip restraint	heupsteen	maintien des hanches
hump cover kit	hump overtrekset	hump cover kit
lumbar support	lendensteen	réglage lombaire
mechanical suspension	mechanische vering	suspension mécanique
middle part	middenstuk	pièce centrale
middle part with heating	middenstuk met verwarming	pièce centrale avec chauffage
middle part with safety switch	middenstuk met microcontact	pièce centrale avec micro-contact de sécurité
min seat height	min. zithoogte	hauteur minimale de l'assise
narrow version	smalle versie	version étroite
non-suspension seat	ongeveerde zetel	siège non suspendu
pvc	pvc	pvc
retractable seat belt	oprolbare gordel	ceinture à enrouleur
safety switch	microcontact	micro-contact de sécurité
seat	zetel	siège
seat angle adjustment	zithoekverstelling	angle d'assise réglable
seat belt bracket	gordelbevestiging	support de ceinture de sécurité
seat belt (black)	veiligheidsgordel (zwart)	ceinture de sécurité (noir)
seat belt (orange)	veiligheidsgordel (oranje)	ceinture de sécurité (orange)
seat cover	zetelhoes	housse de siège
seat cushion	zitkussen	coussin de siège
seat foam	zetelmousse	mousse de siège
seat heating	zetelverwarming	siège chauffant
seat pan	zitpan	assise de siège
shock absorber	schokdemper	amortisseur
shoulder restraint	schoudersteen	maintien des épaules
slide rail	verstelslede	glissière
static seat belt	statische gordel	ceinture de sécurité statique
suspension seat	geveerde stoel	siège suspendu
velvet	fluweel	velours
weight adjustment	gewichtsinstelling	réglage du poids
width	breedte	largeur



NICE TO KNOW

English	Deutsch	Italiano
air suspension	Luftfederung	sospensione ad aria
armrest	Armlehne	poggiabraccia
backrest adjustment	Rückenlehnenverstellung	regolazione schienale
backrest cover	Überzug Rückenpolster	copri schienale
backrest cushion	Rückenpolster	schienale
depth	Tiefe	profondità
document pouch	Dokumentenhalter	porta documenti
fabric	Stoff	tessuto
fixed backrest	Feste Rückenlehne	schienale fisso
foldable back	Klappbare Rückenlehne	schienale ribaltabile
fore/aft adjustment	Vorwärts-/Rückwärtsverstellung	regolazione avanti/indietro
head rest	Kopfstütze	poggia testa
height	Höhe	altezza
height adjustment	Höhenverstellung	regolazione altezza
hip restraint	Hüftstütze	supporto anca
hump cover kit	Lendenwirbelstütze Kit	set copertura schienale
lumbar support	Lendenstütze	supporto lombare
mechanical suspension	Mechanische Federung	sospensione meccanica
middle part	Mittelstück	pezzo centrale
middle part with heating	Mittelstück mit Heizung	pezzo centrale con riscaldamento
middle part with safety switch	Mittelstück mit Sicherheitsschalter	pezzo centrale con interruttore di sicurezza
min seat height	Geringste Sitzhöhe	altezza minima
narrow version	Kompakt-Ausführung	versione stretta
non-suspension seat	Ungefederter Sitz	sedile senza sospensione
pvc	PVC	pvc
retractable seat belt	Aufrollgurt	cintura con arrotolatore
safety switch	Sicherheitsschalter	micro
seat	Sitz	sedile
seat angle adjustment	Sitzwinkelverstellung	regolazione angolo
seat belt bracket	Gurthalterung	suspipcuorrettozzcaintura di
seat belt (black)	Sitzgurt (schwarz)	cintura di sicurezza (in nero)
seat belt (orange)	Sitzgurt (orange)	cintura di sicurezza (in arancione)
seat cover	Sitzbezug	copri seduta
seat cushion	Sitzpolster	cuscino
seat foam	Sitzschaum	sedile in schiuma
seat heating	Sitzheizung	riscaldamento cuscino
seat pan	Sitzschale	seduta
shock absorber	Stoßdämpfer	ammortizzato
shoulder restraint	Schulterstütze	supporto spalle
slide rail	Gleitschiene	regolazione binari
static seat belt	Statischer Sitzgurt	cintura
suspension seat	Gefederter Sitz	sospensione a molle
velvet	Velours	velluto
weight adjustment	Gewichtsverstellung	regolazione peso
width	Breite	larghezza



NICE TO KNOW

English	Español	Português
air suspension	suspensión de aire	suspensão de ar
armrest	reposabrazos	apoio do braço
backrest adjustment	ajuste del respaldo	ajuste do encosto
backrest cover	funda respaldo	forra do encosto
backrest cushion	cojin del respaldo	encosto
depth	profundidad	profundidade
document pouch	porta documentos	porta documentos
fabric	tela	tecido
fixed backrest	respaldo fijo	encosto fixo
foldable back	respaldo plegable	encosto dobrável
fore/aft adjustment	ajuste delante/atrás	ajuste frente/trás
head rest	reposacabeza	apoio da cabeça
height	altura	altura
height adjustment	ajuste de la altura	ajuste da altura
hip restraint	sujeta caderas	apoio do quadril
hump cover kit	hump cover kit	hump cover kit
lumbar support	soporte lumbar	suporte lumbar
mechanical suspension	suspensión mecánica	suspensão mecânica
middle part	parte media	peça central
middle part with heating	parte central con calefacción	parte do meio com aquecedor
middle part with safety switch	parte central con interruptor de seguridad	parte do meio com dispositivo de segurança
min seat height	altura min. asiento	altura mínima de assento
narrow version	version estrecha	versão estreita
non-suspension seat	asiento sin suspensión	banco sem suspensão
pvc	PVC	pvc
retractable seat belt	cinturón enrollable	cinto retrátil
safety switch	micro	interruptor
seat	asiento	banco
seat angle adjustment	ajuste del ángulo del asiento	ajuste do ângulo
seat belt bracket	soporte del cinturón	fixação do cinto
seat belt (black)	cinturón de seguridad (negro)	cinto de segurança (negro)
seat belt (orange)	cinturón de seguridad (naranja)	cinto de segurança (amarelo)
seat cover	funda asiento	forra do assento
seat cushion	cojin del asiento	almofada de assento
seat foam	espuma del asiento	espuma do banco
seat heating	calefacción	aquecimento do banco
seat pan	asiento/respaldo en una pieza	assento
shock absorber	amortiguador	amortecedor
shoulder restraint	sujeta hombros	apoio dos ombros
slide rail	rail deslizante	deslizadores
static seat belt	cinturón estático	cinto estático
suspension seat	asiento con suspensión	banco com amortecedor
velvet	terciopelo	veludo
weight adjustment	ajuste del peso	ajuste do peso
width	anchura	largura



NICE TO KNOW

English	Русский	Polski
air suspension	пневмоподвеска	amortyzacja pneumatyczna
armrest	подлокотник	podłokietnik
backrest adjustment	регулировка спинки	regulacja oparcia
backrest cover	чехол спинки	pokrowiec na oparcie
backrest cushion	подушка спинки	oparcie
depth	глубина	głębokość
document pouch	карман для документов	etui na dokumenty
fabric	ткань	materiał
fixed backrest	неподвижная спинка	stałe oparcie
foldable back	складная спинка	składane oparcie
fore/aft adjustment	регулировка вперед / назад	regulacja przód/tył
head rest	подголовник	zagłówek
height	высота	wysokość
height adjustment	регулировка по высоте	regulacja wysokości
hip restraint	боковое ограничение	ogranicznik biodrowy
hump cover kit	hump cover kit	hump cover kit
lumbar support	поясничная опора	podparcie lędźwiowe
mechanical suspension	механическая подвеска	amortyzacja mechaniczna
middle part	средняя секция	część środkowa
middle part with heating	средняя секция с обогревом	część środkowa z podgrzewaniem
middle part with safety switch	средняя секция с блокиратором	część środkowa z włącznikiem bezpieczeństwa
min seat height	мин. высота сиденья	min. wysokość fotela
narrow version	зауженный вариант	wąska wersja
non-suspension seat	сиденье без подвески	foten nieamortyzowany
pvc	ПВХ	PVC
retractable seat belt	инерционный ремень безопасности	zwijany pas
safety switch	блокиратор	włącznik bezpieczeństwa
seat	сиденье	fotel
seat angle adjustment	регулировка угла наклона	regulacja kąta fotela
seat belt bracket	кронштейн ремня	kłamra pasa
seat belt (black)	ремень безопасности (черный)	pas bezpieczeństwa (czarny)
seat belt (orange)	ремень безопасности (оранжевый)	pas bezpieczeństwa (pomarańczowy)
seat cover	чехол сиденья	pokrowiec na fotel
seat cushion	подушка сиденья	siedzisko
seat foam	поролон сиденья	pianka
seat heating	обогрев сиденья	ogrzewanie fotela
seat pan	чашка сиденья	siedzisko
shock absorber	амортизатор	absorbujący wstrząsy
shoulder restraint	плечевое ограждение	ograniczniki ramion
slide rail	направляющая	prowadnica
static seat belt	статичный ремень безопасности	statyczny pas bezpieczeństwa
suspension seat	сиденье с подвеской	fotel amortyzowany
velvet	велюр	welur
weight adjustment	регулировка по весу	regulator wagi
width	ширина	szerokość



NOTES

NOTES

A large area for taking notes, featuring horizontal dotted lines on a light gray background. The background has a white semi-circle cutout at the bottom.



2

SEATS





NOTES

NOTES

A large area for taking notes, featuring horizontal dotted lines on a light gray background. The background has a white curved shape at the bottom.



2.1

TOTALSOURCE





TS3



Universal seat pan with slide rails
With drain hole

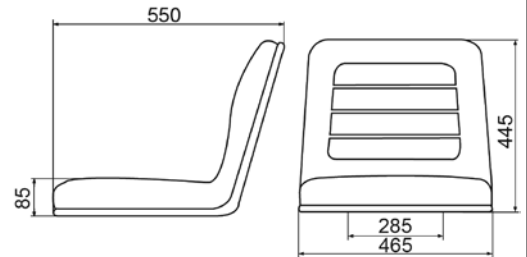

Complete seats

REF PVC

REF fabric

Seat pan with slide rails

[140TA2075](#)

Not available

Accessories

REF PVC

REF fabric

REF general

Slide rails

[152TA1964](#)



TS30



Universal seat pan
With drain hole
Used on Tennant

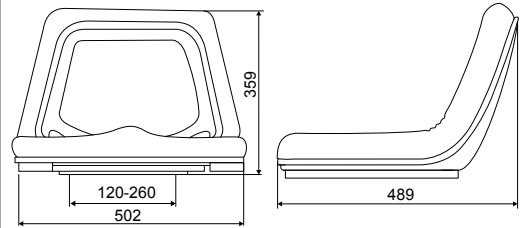

Complete seats

REF PVC

REF fabric

Seat pan

[139TA6707](#)

Not available

Accessories

REF PVC

REF fabric

REF general

Slide rails

[144TA3663](#)



TS32



Universal seat pan with slide rails and seat switch
With drain hole
Used on cleaning machines

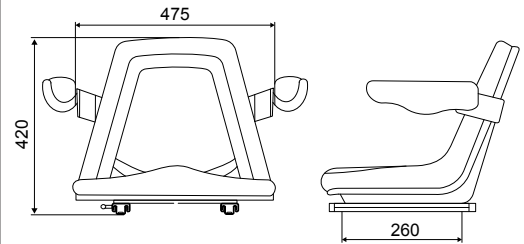

Complete seats

REF PVC

REF fabric

Seat pan

[145TA3347](#)

Not available

Accessories

REF PVC

REF fabric

REF general

Slide rails

[144TA3663](#)



TS35



Universal seat pan with slide rails
Used on Hyster/Yale/Toyota

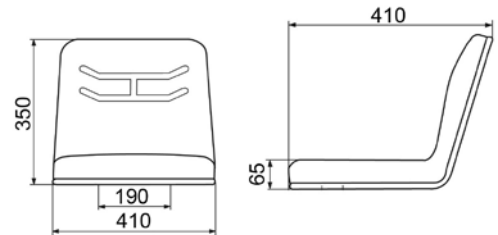

Complete seats

	REF PVC	REF fabric
Seat pan	110TA8626	111TA4084
Seat pan with switch(OPS) + seat belt	128TA4153	On request

Accessories

	REF PVC	REF fabric	REF general
Switch (OPS)			110TA9013
Retractable seat belt*			106TA5149
Seat belt bracket			106TA5154
Slide rails			126TA6095

* Only as a replacement or in combination with the universal seat belt bracket



TS40



Universal seat pan
Used on Hyster/Yale

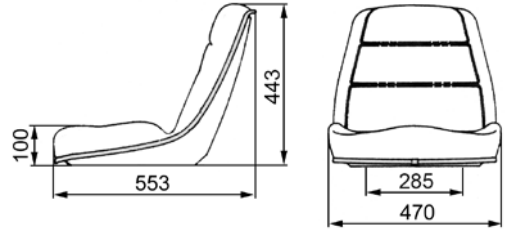

Complete seats

	REF PVC	REF fabric
Seat pan	110TA8627	Not available
Seat pan + slide rails	110TA8629	Not available
Seat pan + slide rails + switch (OPS)	128TA4156	Not available

Accessories

	REF PVC	REF fabric	REF general
Switch (OPS)			106TA5151
Slide rails			144TA5386



TS50



Universal seat pan with slide rails
With drain hole

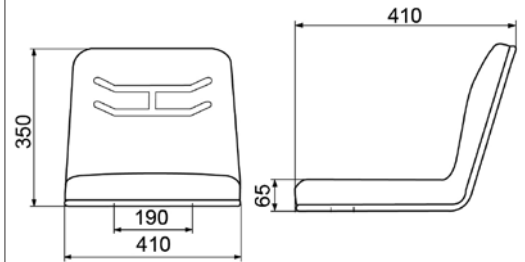

Complete seats

REF PVC

REF fabric

Seat pan with slide rails

[139TA6094](#)

Not available

Accessories

REF PVC

REF fabric

REF general

Slide rails

[147TA5201](#)



TS160



Universal seat pan
With drain hole
Used on tail mounted trucks and cleaning machines
Used on Tennant

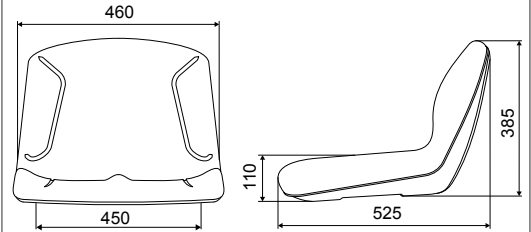

Complete seats

	REF PVC	REF fabric
Metal seat pan	140TA6690	Not available
Plastic seat pan	140TA6689	Not available

Accessories

	REF PVC	REF fabric	REF general
Slide rails			144TA5386
Switch (OPS)	139TA7321		



TS200



Universal seat pan
Non suspended seattop with slide rails
Used on Toyota and TCM

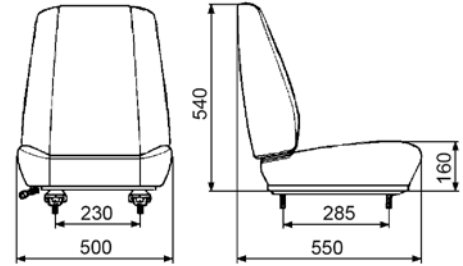

Complete seats

	REF PVC	REF fabric
Seat	110TA8989	Not available
Seat pan with static seat belt	110TA8990	Not available
Seat with retractable seat belt	110TA8991	Not available

Accessories

	REF PVC	REF fabric	REF general
Slide rails			144TA5386
Static seat belt			106TA5150
Retractable seat belt			105TA4857



TS250



Universal seat pan
Non suspended seattop with slide rails

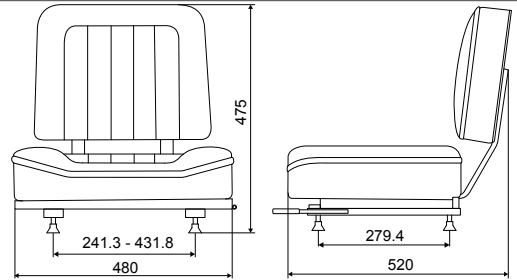

Complete seats

	REF PVC	REF fabric
Seat	145TA2752	Not available

Accessories

	REF PVC	REF fabric	REF general
Seat cushion	110TA9005	Not available	
Backrest cushion	110TA9008	Not available	
Seat belt			108TA8537
Slide rails			144TA5386



TS250-F



Universal seat pan
 Non suspended seattop with slide rails
Foldable backrest
 Ideal for LPG Trucks

Complete seats			
	REF PVC	REF fabric	
Seat	106TA8608	Not available	
Accessories			
	REF PVC	REF fabric	REF general
Seat cushion	110TA9005	Not available	
Backrest cushion	110TA9008	Not available	
Seat belt			108TA8537
Slide rails			144TA5386



TS250-T



Universal seat pan
Non suspended seattop with slide rails
Tilt function

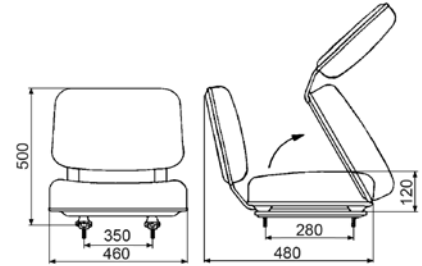

Complete seats

	REF PVC	REF fabric
Seat	110TA9010	Not available

Accessories

	REF PVC	REF fabric	REF general
Seat cushion	110TA9005	Not available	
Backrest cushion	110TA9008	Not available	
Seat belt			108TA8537
Slide rails			144TA5386



TS250-TF



Universal seat pan
Non suspended seattop with slide rails
Tilt function + foldable backrest

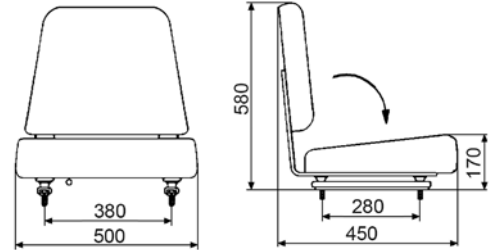

Complete seats

	REF PVC	REF fabric
Seat	110TA9011	Not available

Accessories

	REF PVC	REF fabric	REF general
Seat cushion	110TA9005	Not available	
Backrest cushion	110TA9008	Not available	
Seat belt			108TA8537
Slide rails			144TA5386



TS300



Universal seat pan
Non suspended seattop with slide rails

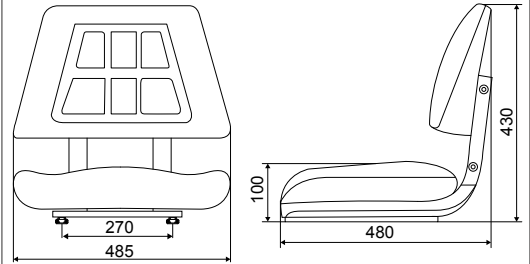

Complete seats

	REF PVC	REF fabric
Seat	110TA8813	Not available
Seat + switch (OPS)	106TA8611	Not available
Seat + Seat belt	110TA8814	Not available
Seat + seat belt + switch (OPS)	110TA8815	Not available

Accessories

	REF PVC	REF fabric	REF general
Seat cushion	110TA8816	Not available	
Seat cushion + switch (OPS)	110TA8817	Not available	
Backrest cushion	110TA8818	Not available	
Retractable seat belt*			106TA5147
Seat belt bracket			106TA5154
Slide rails			106TA8624

* Only as a replacement or in combination with the universal seat belt bracket



ES 10 ECO



Universal non suspended seattop with **foldable backrest**
 Ideal for LPG trucks
 Used on Linde/Jungheinrich

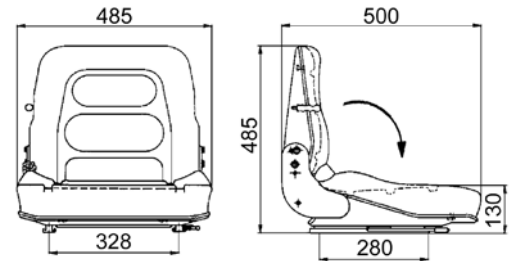

Complete seats

	REF PVC	REF fabric
Seat	139TA4477	
Seat + Seat belt	139TA4478	
Seat + switch (OPS)	139TA4686	140TA8268
Seat + switch (OPS) + seat belt	110TA8783	

Accessories

	REF PVC	REF fabric	REF general
Seat cushion	152TA1950	110TA8706	
Backrest cushion	110TA8707	110TA8708	
Slide rails			106TA8625
Retractable seat belt			140TA8348



TS330



Universal non suspended seattop with seat belt, document holder and slide rails
Used on Clark

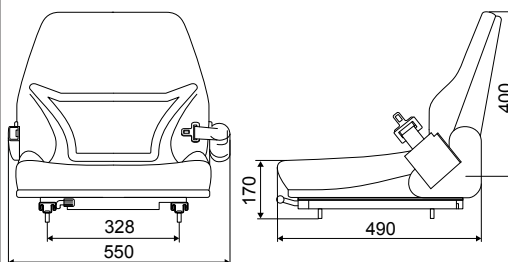

Complete seats

	REF PVC	REF fabric
Seat	136TA1185	Not available

Accessories

	REF PVC	REF fabric	REF general
Seat cushion	145TA2753	Not available	
Backrest cushion	140TA1723	Not available	
Slide rail RH			145TA2754
Slide rail LH			145TA2755
Retractable seat belt			145TA2756
Document holder			145TA2757



TS350



Universal non suspended seattop with **foldable backrest**, document pouch and slide rails
Ideal for LPG trucks
Used on Doosan

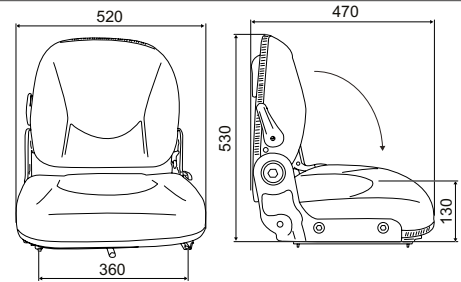

Complete seats

	REF PVC	REF fabric
Seat	126TA6070	Not available
Seat + seat belt	128TA4254	

Accessories

	REF PVC	REF fabric	REF general
Seat cushion	128TA4255	Not available	
Backrest cushion	128TA4256	Not available	
Slide rails			139TA6009
Retractable seat belt			106TA5147



ES 12 ECO



Universal forklift seat with slide rails
Semi-suspended seat
3 step weight adjustment
Adjustable back
Not for intensive use!

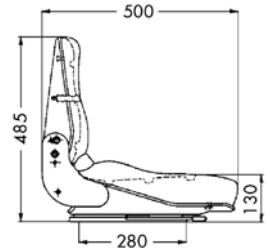
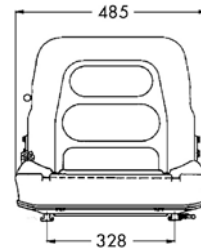

Complete seats

	REF PVC	REF fabric
Seat ECO	131TA2739	Not available
Seat ECO + seat belt	129TA8909	
Seat ECO + switch (OPS)	131TA2740	
Seat ECO + switch (OPS) + seat belt	129TA8910	

Accessories

	REF PVC	REF fabric	REF general
ECO Seat cushion	122TA7479		
ECO Seat cushion + switch (OPS)	122TA7480		
ECO Backrest cushion	122TA7481		
Slide rails			106TA8625
Retractable seat belt			140TA8348
Arm rest kit			110TA8769



ES 12 HD



Universal forklift seat with slide rails
Semi-suspended seat
Adjustable back
3 step weight adjustment

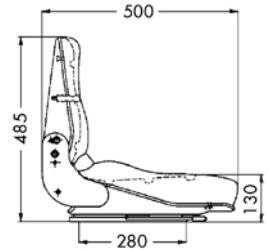
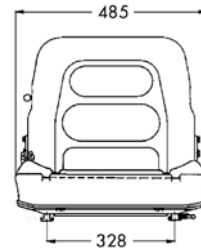

Complete seats

	REF PVC	REF fabric
HD Seat	119TA8975	123TA7574
HD Seat + seat belt	122TA7477	123TA7576
HD Seat + switch (OPS)	139TA6015	123TA7575
HD Seat + switch (OPS) + seat belt	122TA7478	123TA7577

Accessories

	REF PVC	REF fabric	REF general
HD Seat cushion	107TA5258	110TA8743	
HD Seat cushion + switch (OPS)	110TA8744	123TA7579	
HD Backrest cushion	106TA8630	139TA6016	
Slide rails			106TA8625
Retractable seat belt			140TA8348
Arm rest kit			110TA8769



ES12 HD - F



Semi-suspended seat with **foldable backrest** and slide rails
 3 step weight adjustment
 Universal forklift seat
 Ideal for LPG trucks

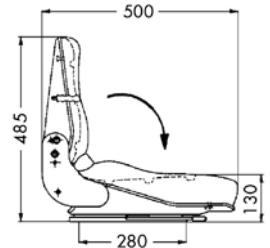
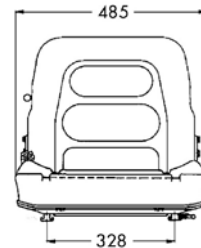

Complete seats

	REF PVC	REF fabric
HD Seat	106TA8622	110TA8773
HD Seat + seat belt	111TA4092	139TA6020
HD Seat + switch (OPS)	110TA8771	110TA8772
HD Seat + switch (OPS) + seat belt	144TA5389	

Accessories

	REF PVC	REF fabric	REF general
HD Seat cushion	107TA5258		
HD Seat cushion + switch (OPS)	110TA8744	123TA7579	
HD Backrest cushion	106TA8630	139TA6016	
Slide rails			106TA8625
Retractable seat belt			140TA8348



ES12 HD SH



Specific seat with document pouch, hip guards and slide rails
Used on Daewoo/Doosan

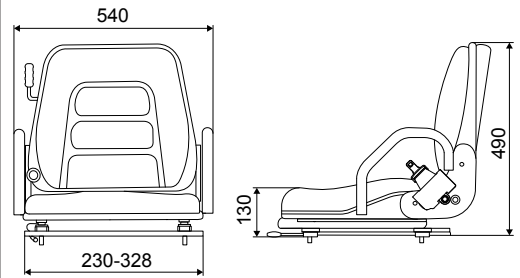

Complete seats

	REF PVC	REF fabric
Seat + switch (OPS) + seat belt	145TA2760	152TA1951

Accessories

	REF PVC	REF fabric	REF general
HD Seat cushion	107TA5258	110TA8743	
HD Seat cushion + switch (OPS)	110TA8744	123TA7579	
HD Backrest cushion	106TA8630	139TA6016	
Slide rails			106TA8625
Retractable seat belt			140TA8348
Hip restraints			110TA8770
Document holder			107TA7952



SPECIFIC ES12 SEATS



Specific seat with armrests and slide rails
Used on Yale/Hyster

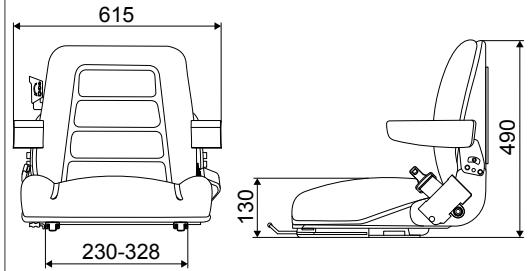

Complete seats

REF PVC

REF fabric

Seat + switch (OPS) + seat belt

[145TA2759](#)

Accessories

REF PVC

REF fabric

REF general

Seat cushion

[110TA8744](#)

Backrest cushion

[106TA8630](#)

Arm rest kit

[110TA8769](#)

Slide rails

[106TA8625](#)

Retractable seat belt

[106TA5149](#)



TS1200



Universal forklift seat with seat belt, document pouch and slide rails
 Mechanical suspension
 Weight adjustment: 50-120 kg
 Used on Hyster

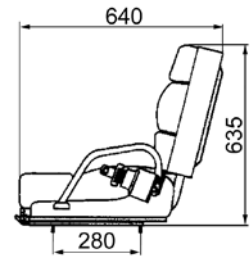
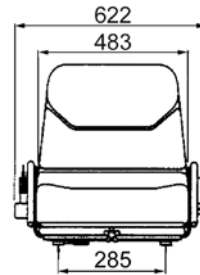

Complete seats

	REF PVC	REF fabric
Seat + seatbelt	110TA8853	Not available
Seat + switch (OPS)	110TA8854	Not available

Accessories

	REF PVC	REF fabric	REF general
Seat cushion	110TA8855	Not available	
Backrest cushion	145TA2761	Not available	
Switch (OPS)			110TA8856
Slide rails			144TA5386
Retractable seat belt			145TA2762



WINGBACK



Universal forklift seat with seat belt and switch (OPS)
Non suspended seat
 Used on Toyota

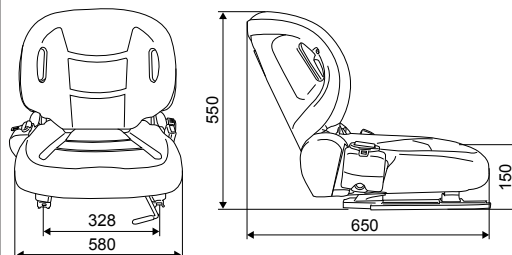

Complete seats

	REF PVC	REF fabric
Seat + switch (OPS) + seat belt	131TA4894	Not available

Accessories

	REF PVC	REF fabric	REF general
Seat cushion	139TA6005	Not available	
Backrest cushion	139TA6006	Not available	
Retractable seat belt			136TA2954
Switch (OPS)			139TA6007
Slide rails			139TA6009



WINGBACK



Universal forklift seat with seat belt, switch (OPS) and slide rails

Mechanical suspension

Weight adjustment: 40-120 kg

Used on Toyota

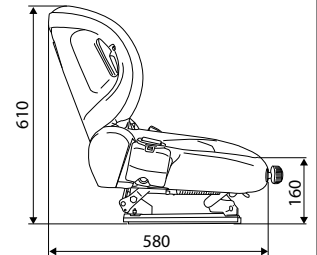
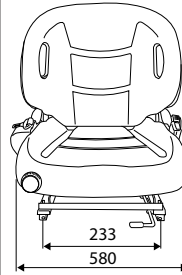

Complete seats

	REF PVC	REF fabric
Seat + switch (OPS) + seat belt	136TA1247	Not available

Accessories

	REF PVC	REF fabric	REF general
Seat cushion	139TA6005	Not available	
Backrest cushion	139TA6006	Not available	
Retractable seat belt			136TA2954
Switch (OPS)			139TA6007
Slide rails			139TA6009



WINGBACK NEXT GENERATION



Universal forklift seat with seat belt, switch (OPS), hip guard and slide rails

Mechanical suspension

Weight adjustment: 40-120 kg

Used on TCM/Komatsu/Mitsubishi/Nissan

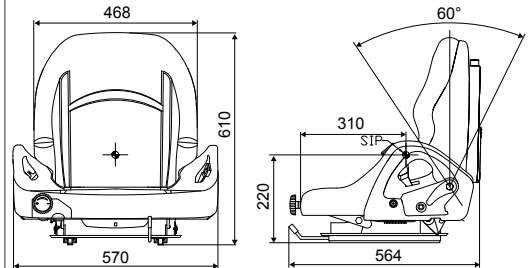

Complete seats

	REF PVC	REF fabric
Seat + switch (OPS) + seat belt	136TA1246	Not available

Accessories

	REF PVC	REF fabric	REF general
Seat cushion	139TA6011	Not available	
Backrest cushion	139TA6012	Not available	
Retractable seat belt			139TA6013
Switch (OPS)			139TA6007
Slide rails			139TA6014



TS240



Universal forklift seat with seat belt, switch (OPS), hip guard and slide rails
 Mechanical suspension
 Weight adjustment: 50-110 kg
 Used on Doosan

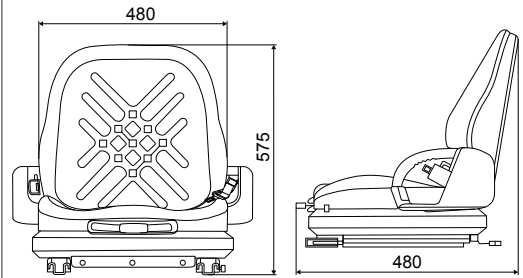

Complete seats

	REF PVC	REF fabric
Seat + switch (OPS) + seat belt	144TA5390	Not available
Seat + switch (OPS) + seat belt+ armrests	147TA5200	Not available

Accessories

	REF PVC	REF fabric	REF general
Seat cushion	144TA5391	Not available	
Backrest cushion	144TA5412	Not available	
Retractable seat belt			145TA2785
Retractable seat belt + switch			140TA1731
Switch (OPS)			144TA5413
Slide rails			144TA5414



T585



Universal forklift seat with seat belt, switch (OPS) and slide rails
 Mechanical suspension
 Weight adjustment: 40-120 kg
 Used on Doosan

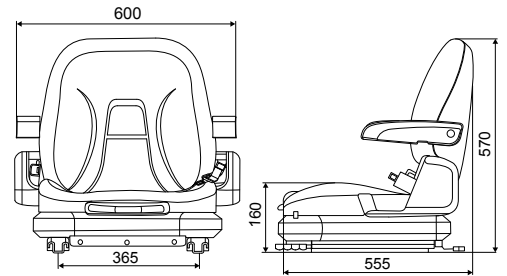

Complete seats

REF PVC

REF fabric

Seat + switch (OPS) + seat belt

[147TA4995](#)

Seat + switch (OPS) + seat belt + arm rests

[145TA2786](#)

Accessories

REF PVC

REF fabric

REF general

Seat cushion

[140TA1727](#)

Backrest cushion

[145TA2787](#)

Retractable seat belt + switch

[140TA1731](#)

Switch (OPS)

[110TA9013](#)

Slide rails

[145TA2788](#)



T586



Universal forklift seat with seat belt, switch (OPS), hipguards and slide rails
 Mechanical suspension
 Weight adjustment: 40-120 kg
 Used on Doosan

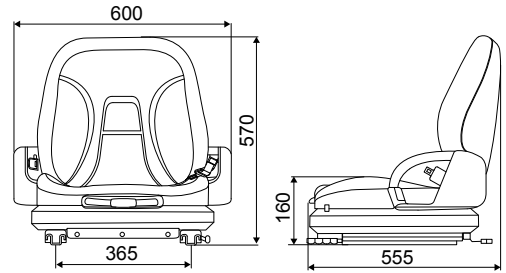

Complete seats

	REF PVC	REF fabric
Seat + switch (OPS) + seat belt	139TA6080	140TA1726

Accessories

	REF PVC	REF fabric	REF general
Seat cushion	140TA1727	140TA1728	
Backrest cushion	145TA2787	140TA1730	
Retractable seat belt + switch			140TA1731
Switch (OPS)			110TA9013
Slide rails			145TA2788



ES29



Universal forklift seat with seat belt, armrests and slide rails
 Mechanical suspension
 Weight adjustment: 50-130 kg
 Used on Hyundai

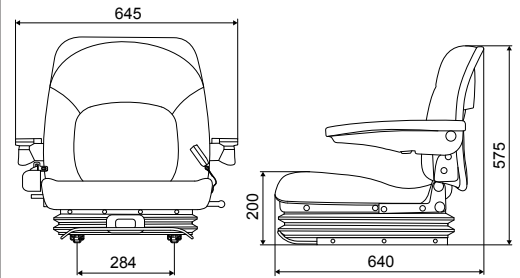

Complete seats

	REF PVC	REF fabric
Seat + seatbelt	145TA2789	Not available
Seat + switch (OPS) + seat belt	145TA2790	Not available

Accessories

	REF PVC	REF fabric	REF general
Seat cushion	145TA2791	Not available	
Backrest cushion	145TA2792	Not available	
Retractable seat belt			105TA4857
Switch (OPS)			106TA5151



TECHNICO



Universal forklift seat with slide rails
 Mechanical suspension
 Weight adjustment: 50-130 kg
 Used on Mitsubishi

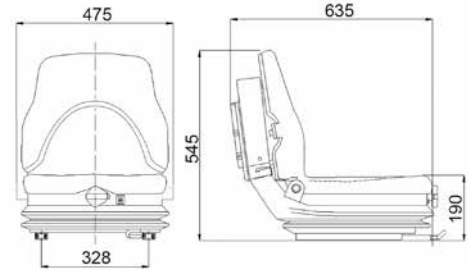

Complete seats

	REF PVC	REF fabric
Seat	110TA8799	139TA6023
Seat + seat belt	110TA8803	139TA6024
Seat + switch (OPS)	123TA7555	111TA4094
Seat + seat belt + switch (OPS)	110TA8804	111TA4095

Accessories

	REF PVC	REF fabric	REF general
Seat cushion	123TA7556	129TA7741	
Seat cushion	144TA3652*		
Backrest cushion	123TA7557	129TA7742	
Backrest cushion	144TA3653*		
Retractable seat belt			108TA8537
Switch (OPS)			128TA4174
Slide rails			123TA7559
Armrest kit			110TA8812

* Grey



TS87



Universal forklift seat with seat belt, document holder and slide rails
 Mechanical suspension
 Weight adjustment: 50-130 kg
 Used on Clark

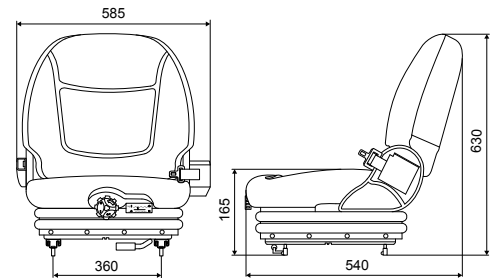

Complete seats

	REF PVC	REF fabric
Seat + seat belt	139TA6079	145TA2816

Accessories

	REF PVC	REF fabric	REF general
Seat cushion	140TA1724	145TA2817	
Backrest cushion	140TA1725	145TA2818	
Retractable seat belt			145TA2756
Switch (OPS)			145TA2814
Slide rails RH			145TA2754
Slide rails LH			145TA2815



LS20/2



Universal forklift seat with seat belt, switch (OPS) and slide rails
Mechanical suspension
Weight adjustment: 50-120 kg

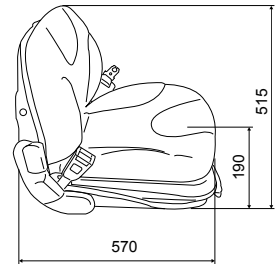
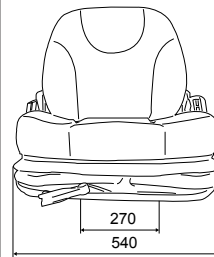

Complete seats

	REF PVC	REF fabric
Seat + switch (OPS) + seat belt	<u>123TA7618</u>	<u>126TA6053</u>
Seat + armrests	<u>126TA6054</u>	

Accessories

	REF PVC	REF fabric	REF general
Seat cushion + switch (OPS)	<u>123TA7674</u>	<u>128TA4243</u>	
Backrest cushion	<u>123TA7619</u>	<u>128TA4244</u>	
Retractable seat belt			<u>108TA8537</u>
Slide rails			<u>141TA5230</u>
Arm rest kit			<u>126TA6055</u>



TS280



Universal forklift seat with seat belt, switch (OPS) and slide rails
 Mechanical suspension
 Weight adjustment: 50-120 kg

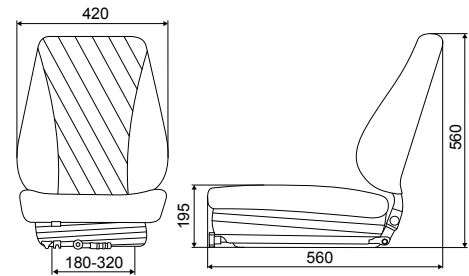

Complete seats

REF PVC

REF fabric

Seat + switch (OPS) + seat belt

[145TA2819](#)

Accessories

REF PVC

REF fabric

REF general

Seat cushion

[147TA3000](#)

Retractable seat belt

[106TA5148](#)



TS301



Universal forklift seat
Mechanical suspension
Weight adjustment: 50-120 kg

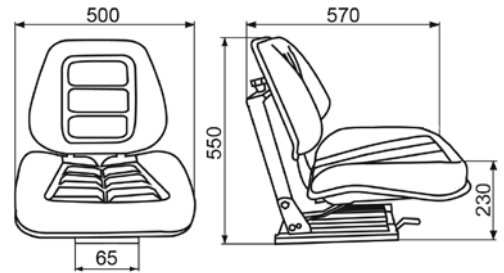

Complete seats

	REF PVC	REF fabric
Seat	145TA2822	Not available
Seat + switch	147TA5203	Not available

Accessories

	REF PVC	REF fabric	REF general
Seat cushion	145TA2823	Not available	
Backrest cushion	145TA2824	Not available	
Switch			106TA5151



TS303



Universal forklift seat
Mechanical suspension
Weight adjustment: 50-120 kg

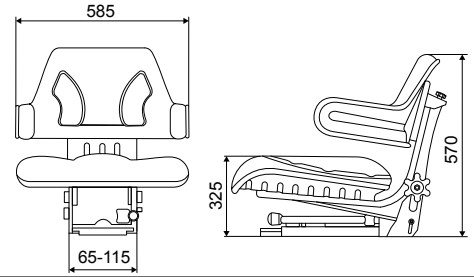

Complete seats

	REF PVC	REF fabric
Seat	145TA2825	Not available



TS305



Universal forklift seat
 Mechanical suspension
 Weight adjustment: 50-120 kg
 Used on Ausa

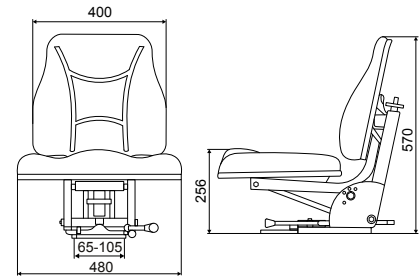

Complete seats

REF PVC

REF fabric

Seat

[142TA2171](#)

Not available

Accessories

REF PVC

REF fabric

REF general

Seat cushion

[145TA2827](#)

Backrest cushion

[145TA2828](#)



TS2460/ES200 (NARROW)



Mechanical suspended seat with slide rails
Weight adjustment: 60-120 kg
Drain hole

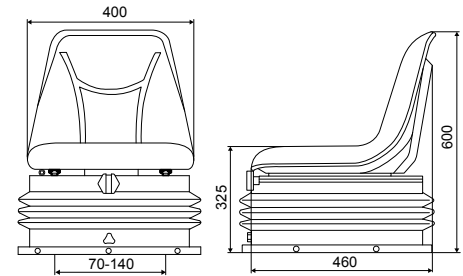

Complete seats

	REF PVC	REF fabric
Seat	140TA2076	Not available
Seat + switch	150TA9832	Not available

Accessories

	REF PVC	REF fabric	REF general
Seat pan	144TA5422	Not available	
Seat pan + switch	150TA9833	Not available	



ES32



Universal forklift seat with seat belt, switch (OPS) and slide rails
 Mechanical suspension
 Weight adjustment: 50-130 kg
 Used on Clark

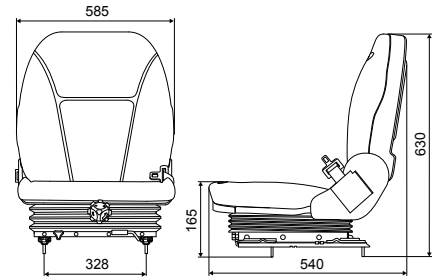

Complete seats

	REF PVC	REF fabric
Seat + switch (OPS) + seat belt	145TA2829	Not available

Accessories

	REF PVC	REF fabric	REF general
Seat cushion	145TA2830	Not available	
Backrest cushion	145TA2831	Not available	
Seat belt			144TA6914



ES33



Universal forklift seat with seat belt, switch (OPS) and slide rails
Mechanical suspension
Weight adjustment: 50-130 kg

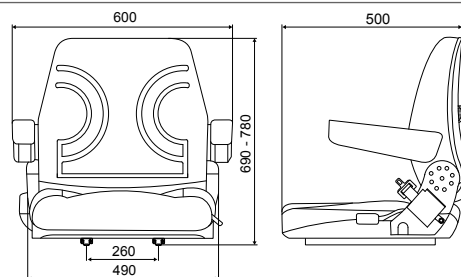

Complete seats

	REF PVC	REF fabric
Seat + switch (OPS) + seat belt	145TA2832	Not available

Accessories

	REF PVC	REF fabric	REF general
Seat cushion	145TA2833	Not available	
Backrest cushion	145TA2834	Not available	
Retractable seat belt			106TA5147
Switch (OPS)			106TA5151
Armrest			147TA5204

ES85/90



Mechanical suspended seat with foldable back and slide rails
Weight adjustment: 60-120 kg

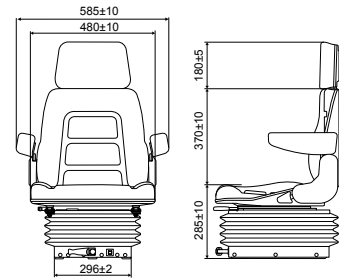

Complete seats

	REF PVC	REF fabric
Seat	147TA3001	152TA1952
Seat + seat belt	147TA3002	152TA1953
Seat + switch (OPS)	110TA8844	152TA1954

Accessories

	REF PVC	REF fabric	REF general
Seat cushion	106TA8627	110TA8794	
Backrest cushion	106TA8629	145TA2835	
Retractable seat belt			106TA5147
Switch (OPS)			106TA5153
Slide rails			106TA8624



TS63/ES200



Mechanical suspended seat with slide rails
Weight adjustment: 60-120 kg

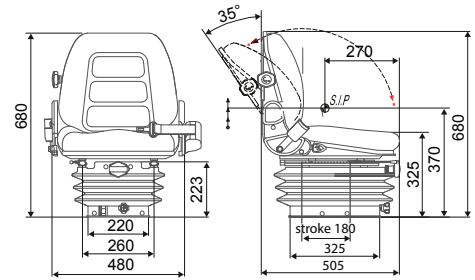

Complete seats

	REF PVC	REF fabric
Seat	144TA3657	147TA5205
Seat + seat belt	144TA3658	147TA5206
Seat + switch (OPS)	144TA3659	
Seat + seat belt + switch (OPS)	144TA3660	147TA5207

Accessories

	REF PVC	REF fabric	REF general
Seat cushion	144TA3661	147TA5208	
Backrest cushion	144TA3662	147TA5209	
Headrest	144TA3665		
Retractable seat belt			106TA5147
Switch (OPS)			106TA5151
Slide rails			144TA3663
Arm rest kit			144TA3664

VS85V



Mechanical suspended seat with slide rails
Weight adjustment: 60-120 kg

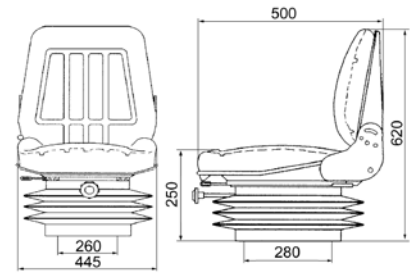

Complete seats

	REF PVC	REF fabric
Seat	105TA4616	110TA8786
Seat + seat belt	110TA8789	110TA8788
Seat + switch (OPS)	110TA8787	110TA8790
Seat + seat belt + switch (OPS)	110TA8791	110TA8792

Accessories

	REF PVC	REF fabric	REF general
Seat cushion	110TA8793	110TA8794	
Backrest cushion	110TA8795	110TA8796	
Headrest	110TA8797	110TA8798	
Retractable seat belt			106TA5147
Switch (OPS)			106TA5151
Slide rails			106TA8625
Arm rest kit			123TA7538



ES2300L



Universal forklift seat with seat belt, switch (OPS) and slide rails
Mechanical suspension
Weight adjustment: 50-120 kg

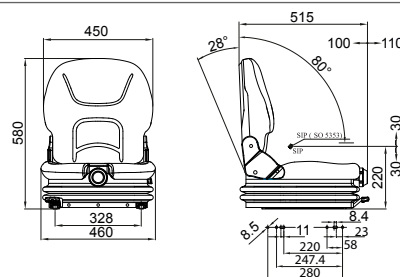

Complete seats

	REF PVC	REF fabric
Seat + switch (OPS) + seat belt	136TA1181	Not available

Accessories

	REF PVC	REF fabric	REF general
Seat cushion	144TA8792		
Backrest cushion	144TA8793		
Retractable seat belt			144TA8794
Switch (OPS)			144TA8795
Slide rails			144TA8796



TS700



Universal forklift seat with seat belt and switch (OPS)
 Mechanical suspension
 Weight adjustment: 50-120 kg
 Used on Fantuzzi

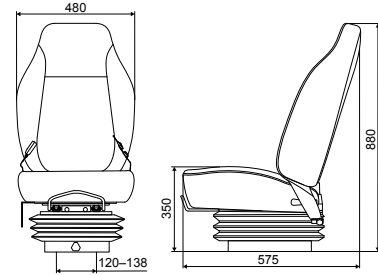

Complete seats

	REF PVC	REF fabric
Seat + switch (OPS) + seat belt	Not available	<u>145TA2836</u>

Accessories

	REF PVC	REF fabric	REF general
Seat cushion	Not available	Not available	
Backrest cushion	Not available	Not available	



TS213



Universal forklift seat with seat belt, switch (OPS) and slide rails
 Mechanical suspension
 Weight adjustment: 50-120 kg

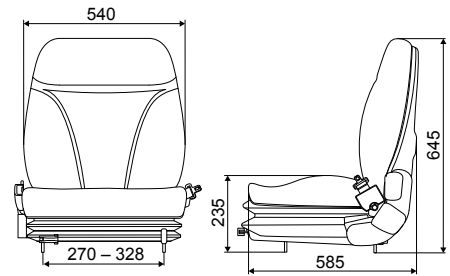

Complete seats

	REF PVC	REF fabric
Seat + switch (OPS) + seat belt	145TA2838	147TA3003

Accessories

	REF PVC	REF fabric	REF general
Seat cushion	145TA2839	147TA3004	
Backrest cushion	145TA2840	147TA3005	
Retractable seat belt			125TA6316
Slide rails			141TA5230

TS710



Mechanical suspended seat with switch (OPS), seat belt and document holder
Weight adjustment: 50-120 kg
Used on Merlo

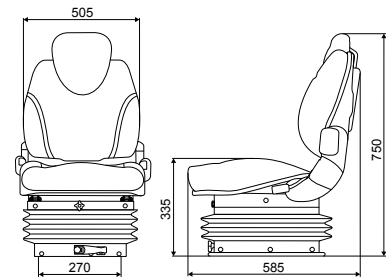

Complete seats

	REF PVC	REF fabric
Seat	Not available	145TA2843
Seat + switch (OPS) + static seat belt	Not available	145TA2844

Accessories

	REF PVC	REF fabric	REF general
Seat cushion	147TA3006	145TA2845	
Backrest cushion		145TA2846	
Static seat belt			147TA3648
Retractable seat belt			106TA5147
Switch (OPS)			141TA5234
Slide rails			145TA2842



TS136



Universal seat
Mechanical suspension
Weight adjustment: 60-130 kg
Used on Manitou

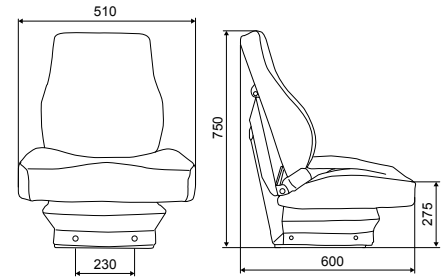

Complete seats

	REF PVC	REF fabric
Seat + static belt	139TA6105	On request
Seat + switch (OPS)	144TA3680	On request
Seat + static belt + switch (OPS)	141TA1590	144TA3681

Accessories

	REF PVC	REF fabric	REF general
Seat cushion	140TA1741	140TA1742	
Seat cushion + switch (OPS)	140TA8740		
Backrest cushion	140TA1743	140TA1744	
Static seat belt			139TA5150
Slide rails			144TA3682

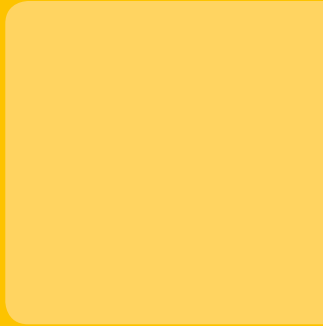
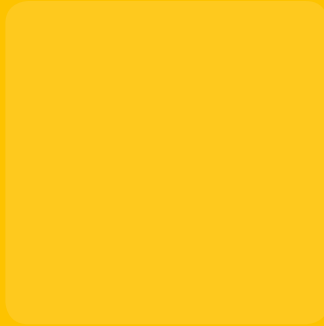

2.2

GRAMMER



B12



Universal forklift seat
Semi-suspended seat
3 step weight adjustment (50-120 kg)
Backrest angle adjustment

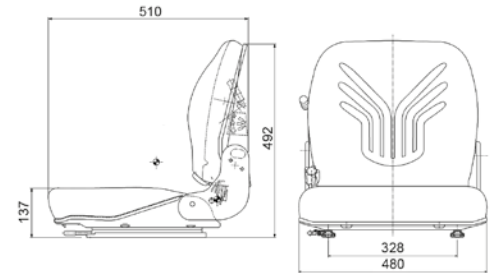

Complete seats

	REF PVC	REF new fabric	REF old fabric	REF black fabric
Seat	126TA6087	Not available	145TA2595	Not available
Seat + switch (OPS)	126TA6088	Not available	Not available	Not available
Seat + seat belt + switch (OPS)	151TA2331	Not available	Not available	Not available

Accessories

	REF PVC	REF new fabric	REF old fabric	REF black fabric	REF general
Seat cushion	141TA5250	Not available	145TA2596	Not available	
Backrest cushion	141TA5249	Not available	145TA2597	Not available	
Slide rails					147TA3451
Switch (OPS)*					142TA1533
Armrest LH					141TA4949
Armrest RH					141TA4950
Document holder					141TA4954
Seat belt					106TA5147

* Only as a replacement part

For more info on the differences between the old and new fabrics, see our Nice to know-document.



We can also provide seats equipped with options



MSG 20



Universal forklift seat
Mechanical suspension
Weight adjustment: 50-130 kg

Complete seats

	REF PVC	REF new fabric	REF old fabric	REF black fabric
Seat	110TA8669	Not available	110TA8670	116TA6080
Seat + switch (OPS)	110TA8671	144TA6912		Not available
Seat + seat belt + switch (OPS)	110TA8675	147TA4632	Not available	Not available
Seat + retractable seat belt	110TA8673	Not available	Not available	110TA8674
Seat + arm rests	110TA8677	Not available	110TA8678	
Seat + seat belt and shoulder restraint system	110TA8679	On request	Not available	110TA8680
Seat + seat belt + switch, doc.holder, pouch and weight adjustment at the front	128TA4161	On request	Not available	128TA4162

Accessories

	REF PVC	REF new fabric	REF old fabric	REF black fabric	REF general
Seat cushion	110TA8681	144TA3684	145TA2600	110TA8682	
Backrest cushion	142TA1532	144TA3685	145TA2601	110TA8684	
Heated seat cushion (12/24 V)*	129TA7775				
Heated backrest cushion (12V/24V)*	129TA7778			147TA3452	
Heating kit 12 V/24 V	141TA4945	145TA2599	141TA4943		
Cable set heating 12 V					152TA2032
Cable set heating 24V					152TA2033
Heating kit 48 V	141TA4946		141TA4944	147TA3453	
Slide rails					123TA7554
Switch (OPS) - 4 pole*					110TA8647
Switch (OPS) - 4 pole new*					145TA2598
Switch connection plate					152TA2034
Armrest LH					110TA8648
Armrest RH					110TA8649
Document holder					107TA7952
Seat belt brackets					110TA8646
Seat belt (Black webbing)					106TA5149
Seat belt (Orange webbing)					142TA3335

* Only available as complete kit

For more info on the differences between the old and new fabrics, see our Nice to know-document.



We can also provide seats equipped with options



MSG 20 NARROW



Universal forklift seat
Mechanical suspension
Weight adjustment: 50-130 kg

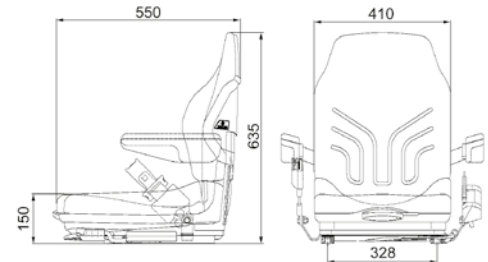

Complete seats

	REF PVC	REF new fabric	REF old fabric	REF black fabric
Seat	110TA8633	147TA4633		Not available
Seat + switch (OPS)	110TA8635	144TA3683		Not available
Seat + seat belt	110TA8637	147TA5079		Not available
Seat + seat belt + switch (OPS)	110TA8639	145TA2602		Not available
Seat + switch + heating 12 V	129TA7738			Not available
Seat + switch + heating 24 V	128TA4158			Not available
Seat + switch + heating 48 V	128TA4159			Not available

Accessories

	REF PVC	REF new fabric	REF old fabric	REF black fabric	REF general
Seat cushion	110TA8641	145TA2603	145TA2687	110TA8642	
Backrest cushion	110TA8643	145TA2604	145TA2688	145TA2605	
Cushion kit heated 12 V/24 V	141TA4947	145TA2599	141TA4943	147TA3453	
Heating kit 48 V	141TA4948		141TA4944		
Slide rails					123TA7554
Switch (OPS) - 4 pole					110TA8647
Switch (OPS) - 4 pole new					145TA2598
Switch connection plate					152TA2034
Armrest LH					110TA8648
Armrest RH					110TA8649
Document holder					107TA7952
Seat belt brackets					110TA8646
Seat belt (Black webbing)					106TA5149
Seat belt (Orange webbing)					142TA3335

For more info on the differences between the old and new fabrics, see our Nice to know-document.



We can also provide seats equipped with options



MSG 30



Universal forklift seat
Mechanical suspension
Weight adjustment: 50-130 kg

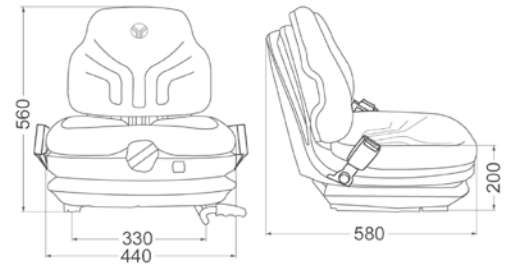

Complete seats

	REF PVC	REF new fabric	REF old fabric	REF black fabric
Seat*	Not available		Not available	Not available

Accessories

	REF PVC	REF new fabric	REF old fabric	REF black fabric	REF general
Seat cushion		110TA8731		110TA8732	
Backrest cushion		110TA8733		110TA8734	
Heating kit 12 V/24 V			147TA3454		
Headrest				128TA4165	
Slide rails					116TA5426
Switch (OPS)					110TA9019
Armrest LH					110TA8737
Armrest RH					110TA8738
Retractable seat belt with knob					139TA5789
Static seat belt					110TA8685

*Replaced by Grammer with the MSG20 and/or Primo XM

For more info on the differences between the old and new fabrics, see our Nice to know-document.



We can also provide seats equipped with options



PRIMO M (MSG65/521)



Universal forklift seat
Mechanical suspension
Weight adjustment: 45-170 kg

Complete seats

	REF PVC	REF new fabric	REF old fabric	REF black fabric
Seat + switch (OPS) + seat belt	139TA6029	145TA2609	Not available	

Accessories

	REF PVC	REF new fabric	REF old fabric	REF black fabric	REF general
Seat cushion	125TA6332	144TA3687	125TA6335	145TA2613	
Backrest cushion	125TA6333	144TA3688	125TA6336	145TA2614	
Backrest extension	125TA6334	144TA3690	125TA6337		
Heated seat cushion (12 V/24 V)	141TA4984	145TA2608	141TA4982	147TA3455	
Heated backrest cushion (12 V/24 V)	141TA4985	145TA2612	141TA4983	147TA3456	
Cable set heating 12 V					141TA4993
Cable set heating 24 V					141TA4994
Heated seat cushion (48 V)	141TA4989		141TA4991		
Heated backrest cushion (48 V)	141TA4990		141TA4992		
Cable set heating 48 V					141TA4995
Slide rails					144TA3689
Switch (OPS)					141TA4996
Armrest LH					141TA4973
Armrest RH					141TA4961
Document holder					141TA4964
ELR LH seat belt					144TA6914
ELR LH seat belt + switch					142TA1538
ELR RH seat belt + switch					141TA4999

For more info on the differences between the old and new fabrics, see our Nice to know-document.



We can also provide seats equipped with options



PRIMO XM (MSG65/521)



Universal forklift seat
Mechanical suspension
Weight adjustment: 45-170 kg

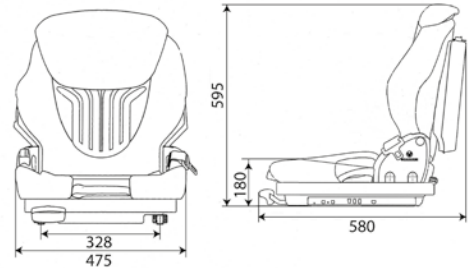

Complete seats

	REF PVC	REF new fabric	REF old fabric	REF black fabric
Seat + switch (OPS) + seat belt	141TA4988	144TA3686	Not available	
Seat + switch (OPS) + seat belt*	145TA2610	145TA2611	Not available	

Accessories

	REF PVC	REF new fabric	REF old fabric	REF black fabric	REF general
Seat cushion	125TA6332	144TA3687	125TA6335	145TA2613	
Backrest cushion	125TA6333	144TA3688	125TA6336	145TA2614	
Backrest extension	125TA6334	144TA3690	125TA6337		
Heated seat cushion (12 V/24 V)	141TA4984	145TA2608	141TA4982	147TA3455	
Heated backrest cushion (12 V/24 V)	141TA4985	145TA2612	141TA4983	147TA3456	
Cable set heating 12 V					141TA4993
Cable set heating 24 V					141TA4994
Heated seat cushion (48 V)	141TA4989		141TA4991		
Heated backrest cushion (48 V)	141TA4990		141TA4992		
Cable set heating 48 V					141TA4995
Slide rails					144TA3689
Switch (OPS)					141TA4996
Armrest LH					141TA4973
Armrest RH					141TA4961
Document holder					141TA4964
ELR LH seat belt					144TA6914
ELR LH seat belt + switch					142TA1538
ELR RH seat belt + switch					141TA4999

* With armrest and backrest extension

For more info on the differences between the old and new fabrics, see our Nice to know-document.



We can also provide seats equipped with options



PRIMO XXM (MSG65/522)



Universal forklift seat
Mechanical suspension
Weight adjustment: 45-170 kg

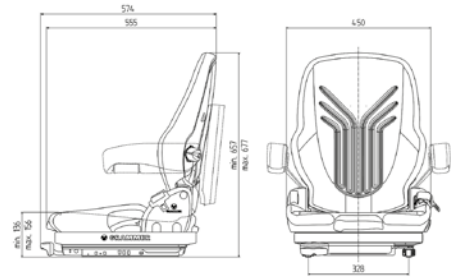

Complete seats

	REF PVC	REF new fabric	REF old fabric	REF black fabric
Seat + switch (OPS) + seat belt	139TA6030	145TA2615	Not available	

Accessories

	REF PVC	REF new fabric	REF old fabric	REF black fabric	REF general
Seat cushion	141TA4976	145TA2616	141TA5252		
Backrest cushion	141TA5253	145TA2617	141TA5251		
Backrest extension	125TA6334	144TA3690	125TA6337		
Heated seat cushion (12 V/24 V)	147TA3457	145TA2618	141TA4974		
Heated backrest cushion (12 V/24 V)	147TA3458	145TA2619	141TA4975		
Cable set heating 12 V					141TA4978
Cable set heating 24 V					141TA4986
Heated seat cushion (48 V)			147TA3459		
Heated backrest cushion (48 V)			147TA3460		
Cable set heating 48 V					141TA4995
Slide rails					144TA3689
Switch (OPS)					141TA4996
Armrest LH					141TA4973
Armrest RH					141TA4961
Document holder					141TA4964
ELR LH seat belt					144TA6914
ELR LH seat belt + switch					142TA1538
ELR RH seat belt + switch					141TA4999

For more info on the differences between the old and new fabrics, see our Nice to know-document.



We can also provide seats equipped with options



MSG65/531



Universal forklift seat
Mechanical suspension
Weight adjustment: 45-170 kg

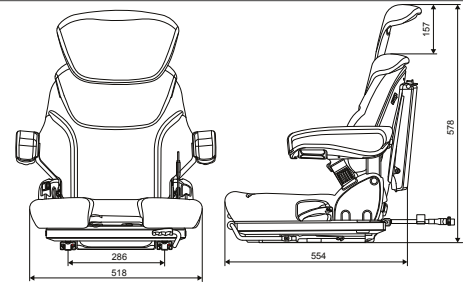

Complete seats

REF PVC REF new fabric REF old fabric REF black fabric

Seat + seat belt [145TA2620](#)

Accessories

REF PVC REF new fabric REF old fabric REF black fabric REF general

Seat cushion [145TA2621](#)

Backrest cushion [145TA2622](#)

Backrest extension [141TA4987](#) [141TA4965](#)

Backrest extension kit [147TA5210](#)

Slide rails [144TA3689](#)

Switch (OPS) [147TA5211](#)

Armrest LH [141TA4973](#)

Armrest RH [141TA4961](#)

Document holder [141TA4964](#)

ELR LH seat belt + switch [142TA1538](#)

ELR RH seat belt + switch [141TA4999](#)

For more info on the differences between the old and new fabrics, see our Nice to know-document.



We can also provide seats equipped with options



PRIMO L (MSG75/521)



Universal forklift seat
Air suspension
Weight adjustment: 45-170 kg

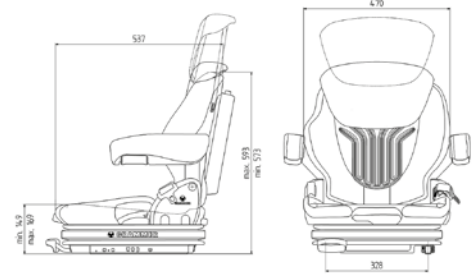

Complete seats

	REF PVC	REF new fabric	REF old fabric	REF black fabric
Seat 12 V + switch (OPS) + seat belt	125TA5082	145TA2623	Not available	
Seat 24 V + switch (OPS) + seat belt	139TA6031	145TA2689	Not available	

Accessories

	REF PVC	REF new fabric	REF old fabric	REF black fabric	REF general
Seat cushion	125TA6332	144TA3687	125TA6335	145TA2613	
Backrest cushion	125TA6333	144TA3688	125TA6336	145TA2614	
Backrest extension	125TA6334	144TA3690	125TA6337		
Heated seat cushion (12 V/24 V)	141TA4984	145TA2608	141TA4982	147TA3455	
Heated backrest cushion (12 V/24 V)	141TA4985	145TA2612	141TA4983	147TA3456	
Cable set heating 12 V					141TA4993
Cable set heating 24 V					141TA4994
Heated seat cushion (48 V)	141TA4989		141TA4991		
Heated backrest cushion (48 V)	141TA4990		141TA4992		
Cable set heating 48 V					141TA4995
Slide rails					144TA3689
Switch (OPS)					141TA4996
Armrest LH					141TA4973
Armrest RH					141TA4961
Document holder					141TA4964
ELR LH seat belt					144TA6914
ELR LH seat belt + switch					142TA1538
ELR RH seat belt + switch					141TA4999

For more info on the differences between the old and new fabrics, see our Nice to know-document.



We can also provide seats equipped with options



PRIMO XL (MSG75/521)



Universal forklift seat with headrest
Air suspension
Weight adjustment: 45-170 kg

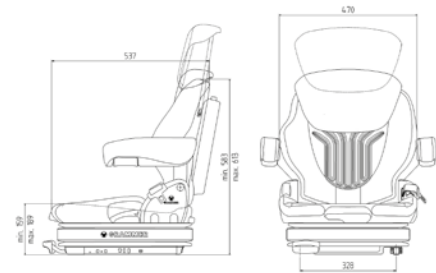

Complete seats

	REF PVC	REF new fabric	REF old fabric	REF black fabric
Seat 12 V + switch (OPS) + seat belt	139TA6032	145TA2624	Not available	
Seat 24 V + switch (OPS) + seat belt	142TA1535	145TA2625	Not available	

Accessories

	REF PVC	REF new fabric	REF old fabric	REF black fabric	REF general
Seat cushion	125TA6332	144TA3687	125TA6335	145TA2613	
Backrest cushion	125TA6333	144TA3688	125TA6336	145TA2614	
Backrest extension	125TA6334	144TA3690	125TA6337		
Heated seat cushion (12 V/24 V)	141TA4984	145TA2608	141TA4982	147TA3455	
Heated backrest cushion (12 V/24 V)	141TA4985	145TA2612	141TA4983	147TA3456	
Cable set heating 12 V					141TA4993
Cable set heating 24 V					141TA4994
Heated seat cushion (48 V)	141TA4989		141TA4991		
Heated backrest cushion (48 V)	141TA4990		141TA4992		
Cable set heating 48 V					141TA4995
Slide rails					144TA3689
Switch (OPS)					141TA4996
Armrest LH					141TA4973
Armrest RH					141TA4961
Document holder					141TA4964
ELR LH seat belt					144TA6914
ELR LH seat belt + switch					142TA1538
ELR RH seat belt + switch					141TA4999

For more info on the differences between the old and new fabrics, see our Nice to know-document.



We can also provide seats equipped with options

PRIMO XXL (MSG75/522)



Universal forklift seat
Air suspension
Weight adjustment: 45-170 kg

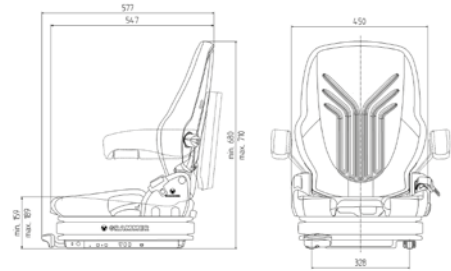

Complete seats

	REF PVC	REF new fabric	REF old fabric	REF black fabric
Seat 12 V + switch (OPS) + seat belt	142TA1534	145TA2626	Not available	
Seat 24 V + switch (OPS) + seat belt	151TA2988	151TA2987	Not available	

Accessories

	REF PVC	REF new fabric	REF old fabric	REF black fabric	REF general
Seat cushion	141TA4976	145TA2616	141TA5252		
Backrest cushion	141TA5253	145TA2617	141TA5251		
Backrest extension	125TA6334	144TA3690	125TA6337		
Heated seat cushion (12 V/24 V)	141TA4976	145TA2618	141TA4974		
Heated backrest cushion (12 V/24 V)	141TA4977	145TA2619	141TA4975		
Cable set heating 12 V					141TA4978
Cable set heating 24 V					141TA4986
Heated seat cushion (48 V)	147TA3457		147TA3459		
Heated backrest cushion (48 V)	147TA3458		147TA3460		
Cable set heating 48 V					141TA4995
Slide rails					144TA3689
Switch (OPS)					141TA4996
Armrest LH					141TA4973
Armrest RH					141TA4961
Document holder					141TA4964
ELR LH seat belt					144TA6914
ELR LH seat belt + switch					142TA1538
ELR RH seat belt + switch					141TA4999

For more info on the differences between the old and new fabrics, see our Nice to know-document.



PRIMO EL PLUS (MSG75L/731)



Universal forklift seat with vibration directive 2002/44/BC
Air suspension 12 V
Weight adjustment: 45-170 kg

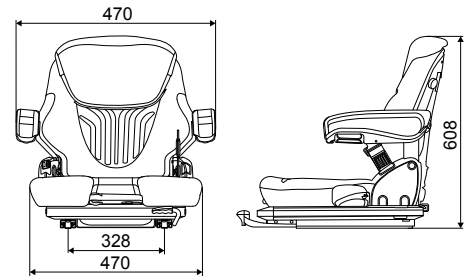

Complete seats

	REF PVC	REF new fabric	REF old fabric	REF black fabric
Seat 12 V + switch (OPS) + seat belt		145TA2690	Not available	

Accessories

	REF PVC	REF new fabric	REF old fabric	REF black fabric	REF general
Seat cushion	140TA1739	145TA2705	141TA5244		
Backrest cushion	141TA5247	145TA2706	141TA5245		
Backrest extension	128TA4164	145TA2633	141TA4923	141TA5065	
Heated seat cushion (12 V)*				128TA4252	
Heated backrest cushion (12 V)*				128TA4253	
Heating kit 12V		147TA3463	147TA3464		
Slide rails					152TA2045
Switch					145TA2693
Compressor kit 24 V					151TA2991
Armrest LH (65 x 270 mm)					141TA4918
Armrest RH (65 x 270 mm)					141TA4917
Armrest LH (80 x 380 mm)					141TA4916
Armrest RH (80 x 380 mm)					141TA4915
Document holder					141TA4913
Seat belt					125TA6316

* Only as replacement part

For more info on the differences between the old and new fabrics, see our Nice to know-document.



We can also provide seats equipped with options



PRIMO XL PLUS (MSG 75G/721)



Universal forklift seat with very low profile suspension
Pneumatic suspension
Weight adjustment: 45-170 kg

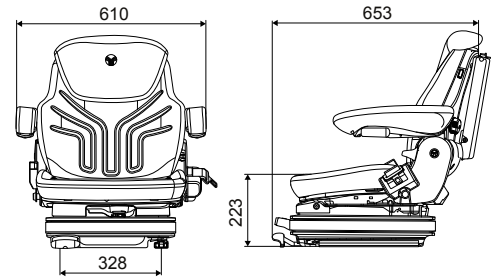

Complete seats

	REF PVC	REF new fabric	REF old fabric	REF black fabric
Seat 12 V + seat belt	141TA4966			

Accessories

	REF PVC	REF new fabric	REF old fabric	REF black fabric	REF general
Seat cushion	110TA8720	145TA2631	141TA5246	110TA8721	
Backrest cushion	110TA8722	145TA2632	141TA5245	110TA8723	
Backrest extension	128TA4164	145TA2633	141TA4923	141TA5065	
Heated seat cushion (12 V)*	145TA2701		141TA4969		
Heated backrest cushion (12 V)*	145TA2702		141TA4970		
Heating kit 12V	141TA4930	145TA2634	141TA4929		
Armrest LH (A60 x 380 mm)					141TA4968
Armrest RH (A60 x 380 mm)					141TA4967
Armrest LH (F65 x 270 mm)					141TA4918
Armrest RH (F65 x 270 mm)					141TA4917
Document holder					141TA4913
Seat belt					144TA8794

* Only as replacement part

For more info on the differences between the old and new fabrics, see our Nice to know-document.



We can also provide seats equipped with options



PRIMO EVOLUTION



Universal forklift seat with active climate & heating vibration directive 2002/44/BC
Air suspension (12 V)
Weight adjustment: 45-170 kg

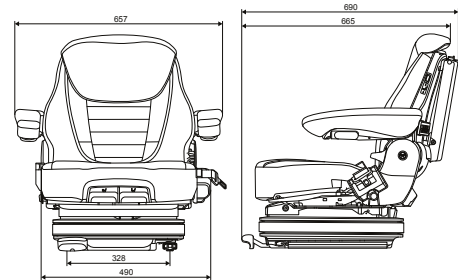

Complete seats

REF PVC REF new fabric REF old fabric REF black fabric

Seat 12 V + switch (OPS) + seat belt [145TA2694](#)

Accessories

REF PVC REF new fabric REF old fabric REF black fabric REF general

Seat cushion [145TA2695](#)

Backrest cushion [145TA2696](#)

Backrest extension [145TA2697](#)

Switch (OPS) [145TA2693](#)

Armrest LH [145TA2698](#)

Armrest RH [145TA2699](#)

Document holder [145TA2700](#)

ELR LH seat belt [116TA5277](#)

Seat belt [125TA6316](#)

For more info on the differences between the old and new fabrics, see our Nice to know-document.



DS85/90V



Universal forklift seat
Mechanical suspension
Weight adjustment: 50-130 kg

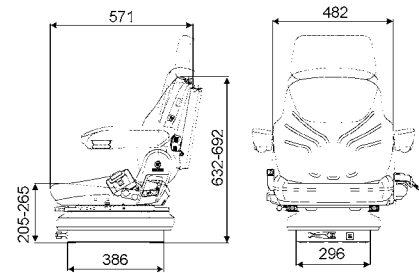

Complete seats

REF PVC REF new fabric REF old fabric REF black fabric

Seat

Not available

Not available

Accessories

REF PVC REF new fabric REF old fabric REF black fabric REF general

Seat cushion

[110TA8720](#)

[110TA8706](#)

Backrest cushion

[110TA8722](#)

[110TA8708](#)

Switch (OPS)

[110TA8725](#)

Slide rails

[106TA8624](#)

Armrest LH

[145TA2628](#)

Armrest RH

[145TA2629](#)

Seat belt

[125TA6316](#)

Replaced by Grammer with the Maximo M (MSG85/721), See pg 77

For more info on the differences between the old and new fabrics, see our Nice to know-document.



We can also provide seats equipped with options



MAXIMO M (MSG85/721)



Universal forklift seat
Mechanical suspension
Weight adjustment: 45-170 kg

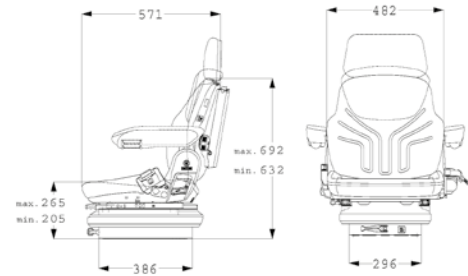

Complete seats

	REF PVC	REF new fabric	REF old fabric	REF black fabric
Seat + switch (OPS) + seat belt	141TA4928	145TA2630	Not available	

Accessories

	REF PVC	REF new fabric	REF old fabric	REF black fabric	REF general
Seat cushion	110TA8720	145TA2631	141TA5246	110TA8721	
Backrest cushion	110TA8722	145TA2632	141TA5245	110TA8723	
Backrest extension	128TA4164	145TA2633	141TA4923	141TA5065	
Heated seat cushion (12 V/24 V)*	145TA2701		141TA4969		
Heated backrest cushion (12 V/24 V)*	145TA2702		141TA4970		
Heating kit 12V (Cushion + cable)	141TA4930	145TA2634	141TA4929		
Slide rails					145TA2636
Switch (OPS)					145TA2635
Switch (OPS) kit with base plate					145TA2703
Armrest LH (65 x 270 mm)					141TA4918
Armrest RH (65 x 270 mm)					141TA4917
Armrest LH (80 x 380 mm)					141TA4916
Armrest RH (80 x 380 mm)					141TA4915
Document holder					141TA4913
ELR LH seat belt					125TA6316

* Only as replacement

For more info on the differences between the old and new fabrics, see our Nice to know-document.



We can also provide seats equipped with options



MAXIMO XM (MSG85/731)



Universal forklift seat
Mechanical suspension
Weight adjustment: 45-170 kg

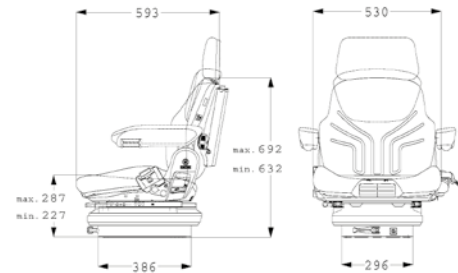

Complete seats

	REF PVC	REF new fabric	REF old fabric	REF black fabric
Seat + switch (OPS) + seat belt	Not available		Not available	

Accessories

	REF PVC	REF new fabric	REF old fabric	REF black fabric	REF general
Seat cushion	140TA1739	145TA2705	140TA1740		
Backrest cushion	110TA8722	145TA2706	141TA5245		
Backrest extension	128TA4164	145TA2633	141TA4965	141TA5065	
Heated seat cushion (12 V/24 V)	152TA2047		145TA2637	128TA4252	
Heated backrest cushion (12 V/24 V)	152TA2048		141TA4970	128TA4253	
Heating kit 12V	141TA4927	147TA3463	141TA4926	147TA3461	
Slide rails					145TA2636
Switch (OPS)					145TA2635
Armrest LH (65 x 270 mm)					141TA4918
Armrest RH (65 x 270 mm)					141TA4917
Armrest LH (80 x 380 mm)					141TA4916
Armrest RH (80 x 380 mm)					141TA4915
Document holder					141TA4913
ELR LH seat belt					125TA6316

For more info on the differences between the old and new fabrics, see our Nice to know-document.



We can also provide seats equipped with options



MAXIMO L (MSG95/721)



Universal forklift seat
Air suspension (12 V)
Weight adjustment: 45-130 kg

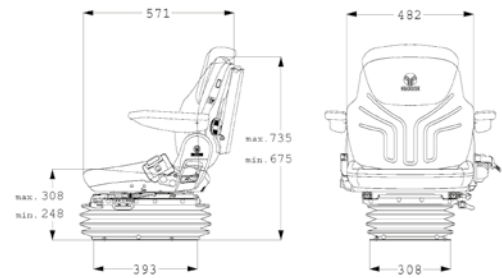

Complete seats

	REF PVC	REF new fabric	REF old fabric	REF black fabric
Seat + switch (OPS) + seat belt	139TA6027	145TA2638	Not available	

Accessories

	REF PVC	REF new fabric	REF old fabric	REF black fabric	REF general
Seat cushion	110TA8720	145TA2631	141TA5246	110TA8721	
Backrest cushion	110TA8722	145TA2632	141TA5245	110TA8723	
Backrest extension	128TA4164	145TA2633	141TA4923	141TA5065	
Heated seat cushion (12 V)*	145TA2701		141TA4969		
Heated backrest cushion (12 V)*	145TA2702		141TA4970		
Heating kit 12V	141TA4930	145TA2634	141TA4929		
Slide rails					145TA2640
Switch (OPS)					145TA2635
Switch (OPS) kit with base plate					145TA2703
Armrest LH (65 x 270 mm)					141TA4918
Armrest RH (65 x 270 mm)					141TA4917
Armrest LH (80 x 380 mm)					141TA4916
Armrest RH (80 x 380 mm)					141TA4915
Document holder					141TA4913
ELR LH seat belt					125TA6316

* Only as replacement

For more info on the differences between the old and new fabrics, see our Nice to know-document.



We can also provide seats equipped with options



MAXIMO XXL (MSG95AL/731, MSG95A/731)



Universal forklift seat
Air suspension
Weight adjustment: 45-130 kg

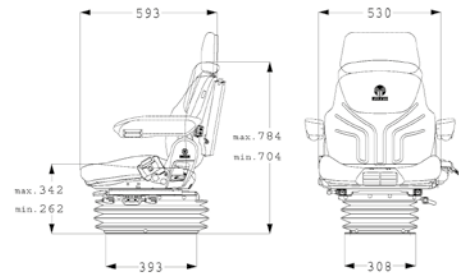

Complete seats

	REF PVC	REF new fabric	REF old fabric	REF black fabric
Seat 12 V + switch (OPS) + seat belt	151TA2989	145TA2704	Not available	
Seat 24 V + switch (OPS) + seat belt	152TA2051	152TA2052	141TA4912	

Accessories

	REF PVC	REF new fabric	REF old fabric	REF black fabric	REF general
Seat cushion	140TA1739	145TA2705	141TA5244		
Backrest cushion	141TA5247	145TA2706	141TA5245		
Backrest extension	128TA4164	145TA2633	141TA4923	141TA5065	
Heated seat cushion (12 V)*	152TA2047		152TA2049	128TA4252	
Heated backrest cushion (12 V)*	152TA2048		152TA2050	128TA4253	
Heating kit 12V	141TA4927	147TA3463	147TA3464	147TA3461	
Slide rails					145TA2710
Switch					151TA2990
Compressor kit 24 V					151TA2991
Armrest LH (65 x 270 mm)					141TA4918
Armrest RH (65 x 270 mm)					141TA4917
Armrest LH (80 x 380 mm)					141TA4916
Armrest RH (80 x 380 mm)					141TA4915
Document holder					141TA4913
Seat belt					125TA6316

* Only as replacement

For more info on the differences between the old and new fabrics, see our Nice to know-document.



We can also provide seats equipped with options



ACTIMO M (MSG 85/722)



Universal construction seat
Mechanical suspension
Weight adjustment: 50-130 kg

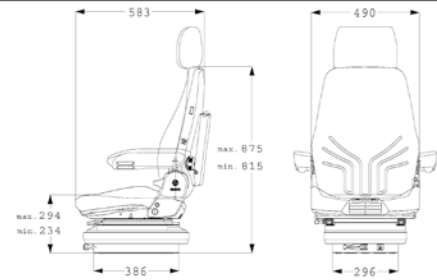

Complete seats

	REF PVC	REF new fabric	REF old fabric	REF black fabric
Seat + switch (OPS) + seat belt	141TA5030	145TA2711	Not available	
Seat + control carriers LH + RH	141TA5037	141TA5033	Not available	

Accessories

	REF PVC	REF new fabric	REF old fabric	REF black fabric	REF general
Seat cushion (490 mm)	145TA2713	145TA2714	147TA3465		
Seat cushion (550 mm)		145TA2715	147TA3466		
Backrest cushion	147TA3468	145TA2716	147TA3467		
Headrest	141TA5014	145TA2717	141TA5012		
Heating kit 12 V (490 mm)		145TA2718	141TA5024		
Heating kit 12 V (550 mm)		145TA2719	141TA5034		
Heating kit 24 V (550 mm)			141TA5035		
Slide rails					145TA2720
Switch (OPS) kit with base plate					141TA5031
Armrest LH (65 x 270 mm)					141TA4918
Armrest RH (65 x 270 mm)					141TA4917
Armrest LH (80 x 380 mm)					141TA4916
Armrest RH (80 x 380 mm)					141TA4915
Document holder					141TA4913
ELR LH seat belt					125TA6316
ELR RH seat belt					145TA2803

For more info on the differences between the old and new fabrics, see our Nice to know-document.



Control carriers



We can also provide seats equipped with options



ACTIMO XL (MSG 95A/722)



Universal construction seat
Air suspension
Weight adjustment: 50-130 kg

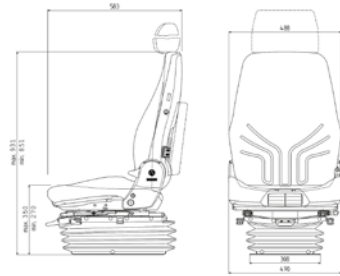

Complete seats

	REF PVC	REF new fabric	REF old fabric	REF black fabric
Seat 12 V + switch (OPS) + seat belt	On demand	145TA2721	Not available	
Seat 24 V + switch (OPS) + seat belt	On demand	145TA2722	Not available	
Seat 24 V + switch (OPS) + seat belt and control carriers LH + RH		147TA4635		

Accessories

	REF PVC	REF new fabric	REF old fabric	REF black fabric	REF general
Seat cushion (490 mm)	145TA2713	145TA2728			
Seat cushion (550 mm)		145TA2715	141TA5015		
Backrest cushion	147TA3468	145TA2729	145TA2726		
Headrest	141TA5014	145TA2717	141TA5012		
Heating kit 12 V (490 mm)			141TA5024		
Heating kit 24 V (490 mm)	141TA5025	145TA2725	141TA5026		
Slide rails					145TA2720
Switch (OPS) with base plate					141TA5018
Armrest LH (65 x 270 mm)					141TA4918
Armrest RH (65 x 270 mm)					141TA4917
Armrest LH (80 x 380 mm)					141TA4916
Armrest RH (80 x 380 mm)					141TA4915
Document holder					141TA4913
ELR LH seat belt					125TA6316
ELR RH seat belt					145TA2803

For more info on the differences between the old and new fabrics, see our Nice to know-document.



Control carriers



We can also provide seats equipped with options



ACTIMO XXL (MSG 97AL/722)



Universal construction seat
Air suspension
Weight adjustment: 50-130 kg

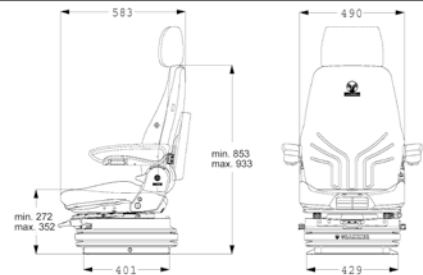

Complete seats

	REF PVC	REF new fabric	REF old fabric	REF black fabric
Seat 24 V + switch (OPS) + seat belt	On demand	145TA2727	Not available	

Accessories

	REF PVC	REF new fabric	REF old fabric	REF black fabric	REF general
Seat cushion (490 mm)	145TA2713	145TA2728	145TA2730		
Backrest cushion	147TA3468	145TA2729	145TA2731		
Headrest	141TA5014	145TA2717	141TA5012		
Heating kit 24 V (490 mm)		147TA5067			
Slide rails					145TA2733
Switch (OPS) with base plate					141TA5018
Armrest LH (65 x 270 mm)					141TA4918
Armrest RH (65 x 270 mm)					141TA4917
Armrest LH (80 x 380 mm)					141TA4916
Armrest RH (80 x 380 mm)					141TA4915
Document holder					141TA4913
ELR LH seat belt					125TA6316
ELR RH seat belt					145TA2803

For more info on the differences between the old and new fabrics, see our Nice to know-document.



We can also provide seats equipped with options



ACTIMO EVOLUTION (MSG 95EL/742) 12 V VERSION FOR WHEELED LOADER



Universal construction seat
Air suspension (12 V)
Weight adjustment: 50-130 kg

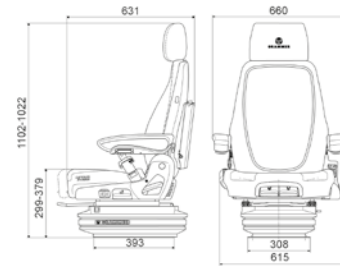

Complete seats

REF PVC REF new fabric REF old fabric REF black fabric

Seat + switch (OPS) + seat belt [145TA2734](#)

Accessories

REF PVC REF new fabric REF old fabric REF black fabric REF general

Seat cushion	152TA2054	145TA2740		
Backrest cushion	145TA2735	145TA2741		
Headrest	145TA2736	145TA2742		
Slide rails				152TA2055
Switch (OPS)				145TA2738
Armrest LH	147TA3469	141TA4957		
Armrest RH	147TA3470	141TA4956		
Document holder				145TA2700
Seat belt				145TA2737

For more info on the differences between the old and new fabrics, see our Nice to know-document.



ACTIMO EVOLUTION (MSG 95EL/742) 24 V VERSION FOR WHEELED LOADER



Universal construction seat
Air suspension (24 V)
Weight adjustment: 50-130 kg

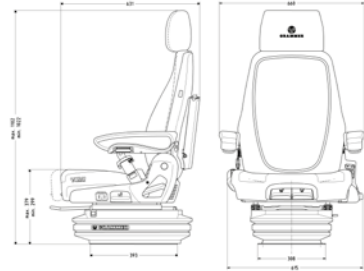

Complete seats

	REF PVC	REF new fabric	REF old fabric	REF black fabric
Seat + switch (OPS) + seat belt		145TA2743	Not available	

Accessories

	REF PVC	REF new fabric	REF old fabric	REF black fabric	REF general
Seat cushion		152TA2056			
Backrest cushion		152TA2057			
Headrest		145TA2736	145TA2742		
Slide rails					152TA2055
Switch (OPS)					145TA2738
Armrest LH		147TA3469	141TA4957		
Armrest RH		147TA3470	141TA4956		
Document holder					145TA2700
Seat belt					145TA2737

For more info on the differences between the old and new fabrics, see our Nice to know-document.



We can also provide seats equipped with options



ACTIMO EVOLUTION (MSG 95EL/722) 12 V VERSION FOR EXCAVATOR



Universal construction seat
Air suspension (12 V)
Weight adjustment: 50-130 kg

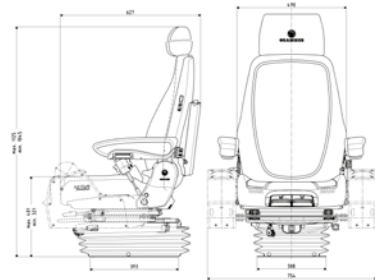

Complete seats

	REF PVC	REF new fabric	REF old fabric	REF black fabric
Seat + switch (OPS) + seat belt and control carriers LH + RH		145TA2744	Not available	

Accessories

	REF PVC	REF new fabric	REF old fabric	REF black fabric	REF general
Seat cushion		145TA2747	145TA2748		
Backrest cushion		145TA2741	145TA2735		
Headrest		145TA2736	145TA2742		
Slide rails					152TA2055
Switch (OPS)					145TA2738
Armrest LH		147TA3469	141TA4957		
Armrest RH		147TA3470	141TA4956		
Document holder					145TA2700
Seat belt					145TA2745

For more info on the differences between the old and new fabrics, see our Nice to know-document.



We can also provide seats equipped with options

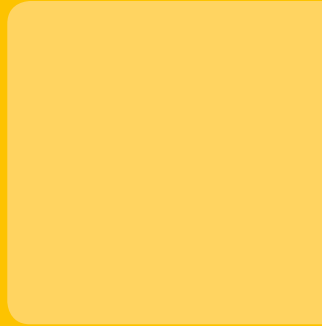
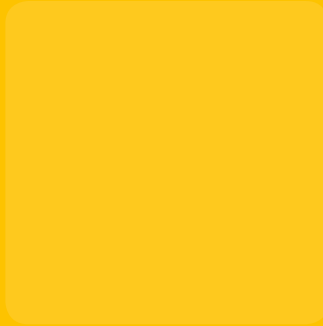

2.3

KAB

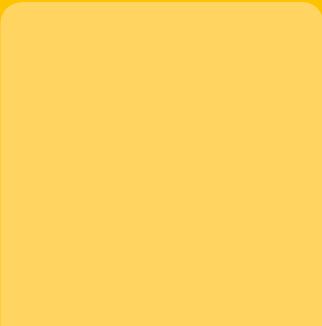



P1



Complete seats

REF PVC

REF fabric

Seat

[126TA6096](#)

Not available

Accessories

REF PVC

REF fabric

REF general

Slide rails

[144TA5348](#)



P2



Universal seat pan
With drain hole

Complete seats			
	REF PVC	REF fabric	
Seat	<u>139TA6039</u>	Not available	
Accessories			
	REF PVC	REF fabric	REF general
Slide rails			<u>144TA5348</u>



P4



Universal seat pan
With drain hole

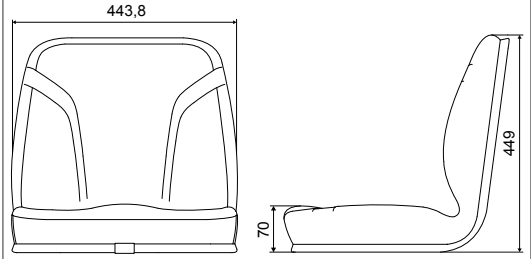

Complete seats

	REF PVC	REF fabric
Seat	Not available	Not available

Replacement seat pan = P6



P6



Universal seat pan
With drain hole

Complete seats			
	REF PVC	REF fabric	
Seat	139TA6041	144TA5373	
Accessories			
	REF PVC	REF fabric	REF general
Headrest	144TA5350		
Slide rails			144TA5353
Static seat belt (Kit)			144TA5351
Armrest kit			144TA5352



T1



Non suspended seat top
Used on JCB

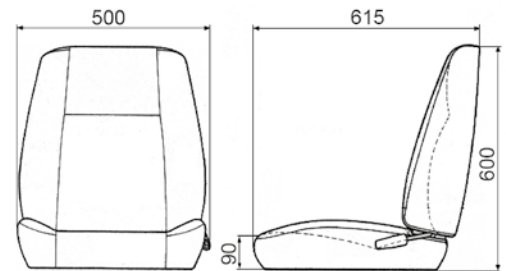

Complete seats

	REF PVC	REF fabric
Seat + slide rails		110TA8931
Seat + slide rails	110TA8930 *	
Seat + switch + slide rails	152TA1955	

Accessories

	REF PVC	REF fabric	REF general
Seat cover kit	110TA8940*	110TA8941	
Seat foam kit			110TA8942
Backrest cover kit	110TA8943*	110TA8944	
Backrest foam kit			110TA8945
Headrest	110TA8960		
Switch (OPS)			110TA8932
Armrest kit			141TA7803
Seat belt (Black)			141TA7802

* Breathable PVC

T4



Non suspended seat top

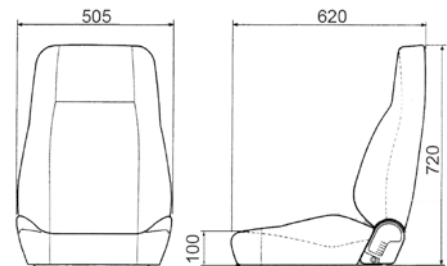

Complete seats

	REF PVC	REF fabric
Seat	110TA8934	110TA8935

Accessories

	REF PVC	REF fabric	REF general
Seat cover kit	128TA4231	129TA7743	
Seat foam kit			128TA4232
Backrest cover kit	128TA4233	129TA7744	
Backrest foam kit			128TA4234
Headrest	110TA8970	110TA8971	
Switch (OPS)			110TA8936
Seat belt (Black)			141TA7802
Armrest kit			110TA8937



T6



Non suspended seattop
Used on Linde/Still

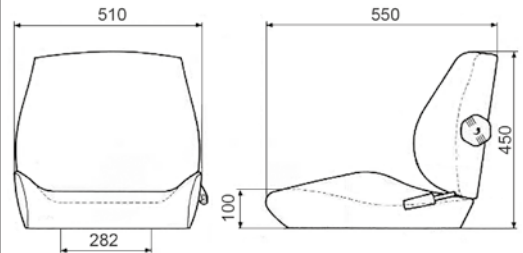

Complete seats

	REF PVC	REF fabric
Seat	126TA6072	128TA4241
Seat + slide rails + switch	144TA5368	139TA6114

Accessories

	REF PVC	REF fabric	REF general
Seat cover kit	126TA6073	128TA4242	
Seat foam kit			126TA6074
Backrest cover kit	144TA5367	129TA7747	
Backrest foam kit			129TA7746
Switch (OPS)			110TA8936
Armrest kit			141TA7803
Headrest			144TA5726
Seat belt (Black)			141TA7802



XH2/P1



Mechanical suspended seat
Weight adjustment: 50-120 kg
Used on Linde

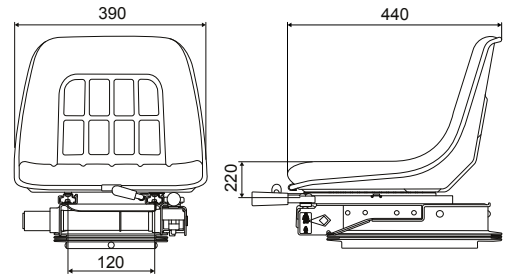

Complete seats

REF PVC

REF fabric

Seat

[147TA3398](#)

Accessories

REF PVC

REF fabric

REF general

Seat top

[126TA6096](#)

Slide rails

[144TA5372](#)

Suspension

[152TA1957](#)



XH2/P2



Mechanical suspended seat
Weight adjustment: 50-120 kg

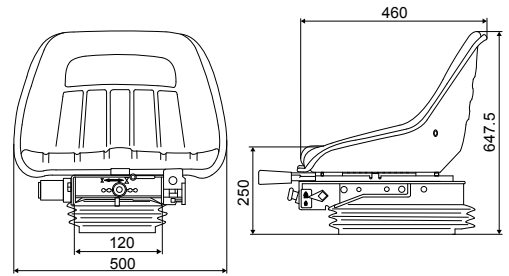

Complete seats

REF PVC

REF fabric

Seat

[141TA7757](#)

Accessories

REF PVC

REF fabric

REF general

Seat top

[139TA6039](#)

Slide rails

[144TA5372](#)

Suspension

[152TA1957](#)

XH2/P6



Mechanical suspended seat with headrest
Weight adjustment: 50-120 kg

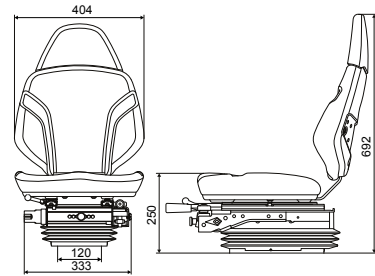

Complete seats

REF PVC

REF fabric

Seat

[139TA6042](#)

Accessories

REF PVC

REF fabric

REF general

Seat top

[139TA6041](#)

[144TA5373](#)

Slide rails

[144TA5372](#)

Static seat belt kit (black)

[144TA5351](#)

Armrest kit

[144TA5352](#)

Headrest

[144TA5350](#)

Suspension

[152TA1957](#)



XH2/T6



Mechanical suspended seat with headrest
Weight adjustment: 50-120 kg
Used on Bobcat

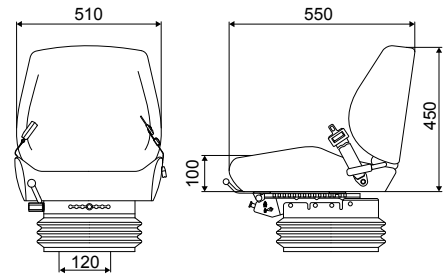

Complete seats

	REF PVC	REF fabric
Seat	Not available	147TA3399

Accessories

	REF PVC	REF fabric	REF general
Seat cover	126TA6073	128TA4242	
Seat foam			126TA6072
Backrest cover	144TA5367	129TA7747	
Backrest foam			129TA7746
Slide rails			144TA5372
Armrest kit			141TA7803
Static seat belt kit (Black)			147TA3648
Suspension			152TA1957



116



Mechanical suspended seat
Weight adjustment: 50-120 kg
Used on telehandlers, wheelloaders, excavators

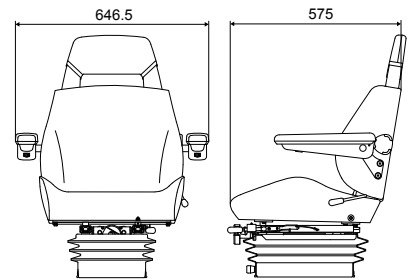

Complete seats

	REF PVC	REF fabric
Seat	147TA4992*	NLA

Accessories

	REF PVC	REF fabric	REF general
Seat cover	129TA7745*	128TA4242	
Seat foam			110TA8942
Backrest cover	144TA5725*	129TA7747	
Backrest foam			129TA7746
Backrest extension	129TA7748	144TA5726	
Switch (OPS)			110TA8936
Armrest kit			141TA7803
Seat belt (Black)			141TA7802

* Breathable PVC



11E6 STANDARD



Mechanical suspended seat
Weight adjustment: 50-120 kg

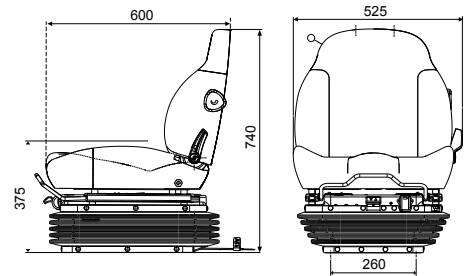

Complete seats

	REF PVC	REF fabric
Seat	Not available	147TA3402
Seat + seat belt	144TA5729	

Accessories

	REF PVC	REF fabric	REF general
Seat cover	144TA5730	147TA3403	
Seat foam			144TA3668
Backrest cover	144TA5731	147TA3404	
Backrest foam			144TA3670
Backrest extension	144TA5732	147TA3405	
Slide rails			144TA5372
Switch (OPS)			110TA8932
Armrest kit			141TA7803
Seat belt (black)			141TA7802

11E6 (KAB BY TVH)



Mechanical suspended seat
Weight adjustment: 50-120 kg

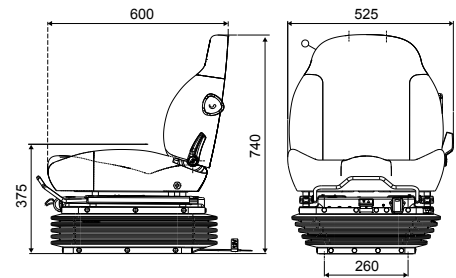

Complete seats

	REF PVC	REF fabric
Seat	Not available	141TA7758
Seat + seat belt	144TA5729	147TA3406

Accessories

	REF PVC	REF fabric	REF general
Seat cover	144TA5730	144TA3667	
Seat foam			144TA3668
Backrest cover	144TA5731	144TA3669	
Backrest foam			144TA3670
Backrest extension	144TA5732	141TA7759*	
Slide rails			144TA5372
Switch (OPS)			110TA8932
Armrest kit			141TA7803
Seat belt (black)			141TA7802

* TotalSource headrest



11E1 (KAB BY TVH)



Mechanical suspended seat
Weight adjustment: 50-120 kg
Used on JCB

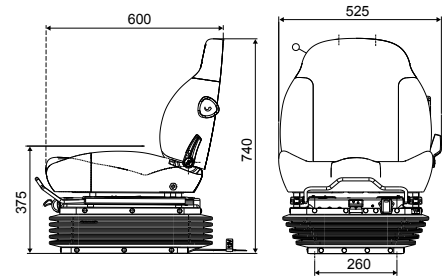

Complete seats

	REF PVC	REF fabric
Seat	Not available	141TA7732
Seat + seat belt	Not available	147TA3407

Accessories

	REF PVC	REF fabric	REF general
Seat cover	144TA5730	144TA3667	
Seat foam			144TA3668
Backrest cover	144TA5733	144TA5735	
Backrest foam			144TA5734
Backrest extension		141TA7759*	
Slide rails			144TA5372
Switch (OPS)			110TA8932
Armrest kit			141TA7803
Seat belt (black)			141TA7802

* TotalSource headrest

11L2



Mechanical suspended seat
Weight adjustment: 50-120 kg
Used on Linde/Still

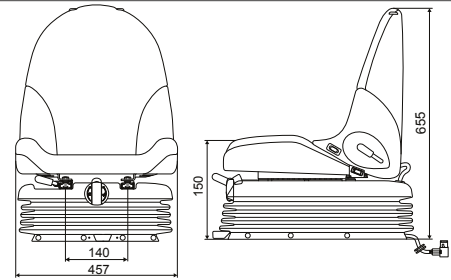

Complete seats

	REF PVC	REF fabric
Seat	152TA1958	139TA6087

Accessories

	REF PVC	REF fabric	REF general
Seat cover	152TA1958	139TA6090	
Seat foam			139TA6088
Slide rails			147TA3408
Switch (OPS)			152TA1959



156



Air suspended seat
Weight adjustment: 50-120 kg
Used on telehandlers, wheelloaders, excavators

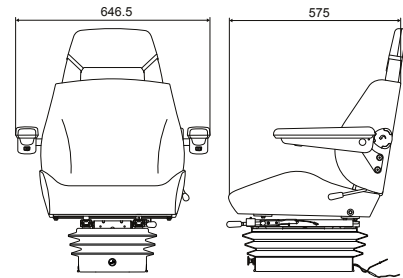

Complete seats

	REF PVC	REF fabric
Seat (12 V)		144TA5727
Seat (12 V) + armrests + headrest		144TA5728

Accessories

	REF PVC	REF fabric	REF general
Seat cover	129TA7745*	128TA4242	
Seat foam			110TA8942
Backrest cover	144TA5725*	129TA7747	
Backrest foam			129TA7746
Backrest extension	129TA7748*	144TA5726	
Switch (OPS)			110TA8936
Armrest kit			141TA7803
Seat belt (Black)			141TA7802

* Breathable PVC

15E1 (KAB BY TVH)



Air suspended seat
Weight adjustment: 50-120 kg
Used on telehandlers, wheelloaders, excavators

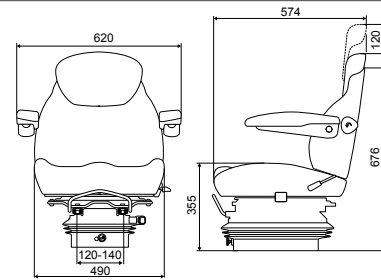

Complete seats

	REF PVC	REF fabric
Seat (12 V)	Not available	141TA7731

Accessories

	REF PVC	REF fabric	REF general
Seat cover	144TA5730**	144TA3667	
Seat foam			144TA3668
Backrest cover	144TA5733**	144TA5735	
Backrest foam kit			144TA5734
Backrest extension		141TA7759*	
Slide rails			147TA3409
Switch (OPS)			110TA8932
Armrest kit			141TA7803
Seat belt (black)			141TA7802

* TotalSource headrest

** Inclusive foam



211



Mechanical suspension
Universal forklift seat
Weight adjustment: 50-120 kg

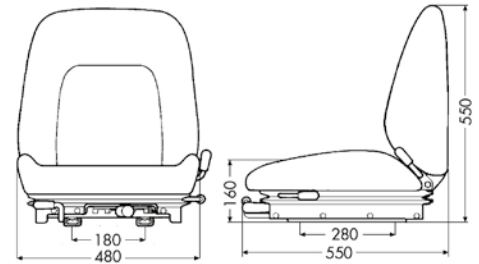

Complete seats

	REF PVC	REF fabric
Seat	110TA8875	110TA8876
Seat + seat belt	110TA8879	123TA7547
Seat + switch (OPS)	110TA8877	123TA7546
Seat + seat belt + switch (OPS)	110TA8880	123TA7548

Accessories

	REF PVC	REF fabric	REF general
Seat cushion cover	110TA8883	110TA8884	
Seat cushion foam			110TA8885
Backrest cover kit	110TA8886	110TA8887	
Backrest cushion foam			110TA8888
Middle part	110TA8889	110TA8890	
Middle part with heating 12 V	110TA8891		
Middle part with heating 24 V	110TA8892		
Middle part with heating 48 V	110TA8893		
Middle part with safety switch	110TA8894	152TA1961	
Slide rails			110TA8898
Switch (OPS)			123TA7549
Arm rest kit			123TA7550
Hip guards			110TA8899
Retractable seat belt (black)			106TA5147

212



Mechanical suspension
 Universal forklift seat
 Weight adjustment: 50-120 kg
 Used on Linde/Still

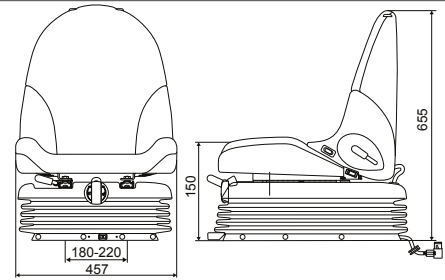

Complete seats

	REF PVC	REF fabric
Seat + switch (OPS)	139TA6084	139TA6085
Seat + switch (OPS) + heating 48 V	147TA3410	

Accessories

	REF PVC	REF fabric	REF general
Seat cover kit	139TA6089	139TA6090	
Seat foam kit			139TA6088
Slide rails			147TA3408
Switch (OPS)			152TA1959



214



Mechanical suspension
Universal forklift seat
Weight adjustment: 50-120 kg

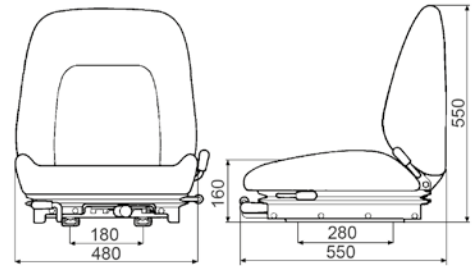

Complete seats

	REF PVC	REF fabric
Seat	123TA7568	123TA7571
Seat + switch (OPS)	123TA7569	123TA7572
Seat + switch (OPS) + seat belt	123TA7570	123TA7573

Accessories

	REF PVC	REF fabric	REF general
Seat cover kit	144TA5739	144TA5745	
Seat foam kit			144TA5742
Backrest cover kit	144TA5740	144TA5746	
Backrest foam kit			144TA5743
Hump cover kit	144TA5741	144TA5747	
Slide rails			110TA8898
Switch (OPS)			110TA8897
Armrest kit			144TA5744
Hip guards			110TA8899
Seat belt (black)			106TA5147

21T1



Mechanical suspension
Universal forklift seat
Weight adjustment: 50-120 kg

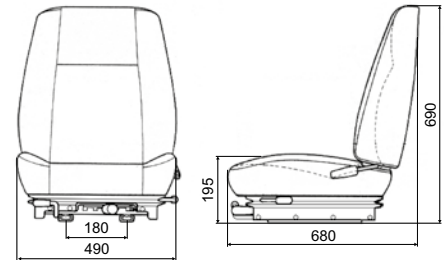

Complete seats

	REF PVC	REF fabric
Seat	<u>126TA6080*</u>	<u>126TA6081</u>

Accessories

	REF PVC	REF fabric	REF general
Seat cover kit	<u>110TA8940*</u>	<u>110TA8941</u>	
Seat foam kit			<u>110TA8942</u>
Backrest cover kit	<u>110TA8943*</u>	<u>110TA8944</u>	
Backrest foam kit			<u>110TA8945</u>
Headrest	<u>110TA8960</u>	<u>144TA5358</u>	
Slide rails			<u>110TA8898</u>
Switch (OPS)			<u>110TA8932</u>
Armrest kit			<u>141TA7803</u>
Seat belt (black)			<u>141TA7802</u>

* Breathable PVC



254 AIR



Air suspension
Universal forklift seat
Weight adjustment: 50-120 kg

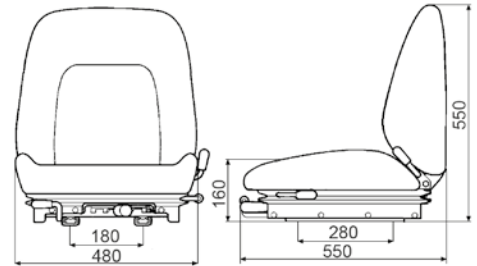

Complete seats

	REF PVC	REF fabric
Seat (12 V)	126TA6071	128TA4247
Seat (12 V) + switch	128TA4248	144TA5750
Seat (12 V) + switch + belt	128TA4249	144TA5751
Seat (24 V)	144TA5748	128TA4250
Seat (24 V) + switch + belt	144TA5749	144TA5752

Accessories

	REF PVC	REF fabric	REF general
Seat cover kit	144TA5739	144TA5745	
Seat foam kit			144TA5742
Backrest cover kit	144TA5740	144TA5746	
Backrest foam kit			144TA5743
Hump cover kit	144TA5741	144TA5747	
Slide rails			110TA8898
Switch (OPS)			110TA8897
Armrest kit			144TA5744
Hip guards			110TA8899
Seat belt (black)			106TA5147

COMPACT



Mechanical suspension
Universal forklift seat
Weight adjustment: 50-120 kg

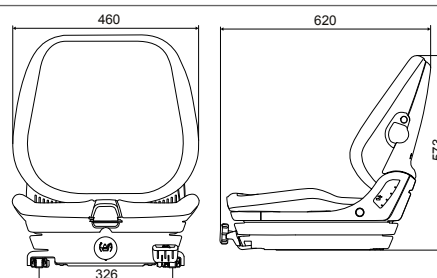

Complete seats

	REF PVC	REF fabric
Seat	139TA4571	141TA1572

Accessories

	REF PVC	REF fabric	REF general
Seat cushion	141TA1570	141TA1573	
Backrest cushion	141TA1571	141TA1574	
Slide rails			144TA5753
Switch (OPS)			141TA1575
Seat belt (black)			144TA5754



SENTINEL 60 SUSPENSION MECHANICAL



Mechanical suspension
Universal forklift seat
Weight adjustment: 50-120 kg

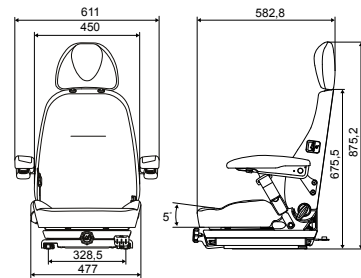

Complete seats

	REF PVC	REF fabric
Seat + OPS (switch)	144TA5755	Not available
Seat heated + switch (OPS) + 48 V heating	144TA5756*	

Accessories

	REF PVC	REF fabric	REF general
Seat cushion + OPS (switch)	147TA3432	147TA3442	
Seat cushion + OPS (switch) + 48 V heating	147TA3434	147TA3438**	
Backrest cushion	147TA3433		
Backrest cushion + 48 V heating	147TA3435	147TA3439**	
Backrest extension	144TA5758	144TA5765	
Headrest	144TA5757	144TA5764	
Armrest kit LH			144TA5760
Armrest kit RH			144TA5762

* Mix PVC/Fabric

**With mechanical lumbar support and document holder

SENTINEL 60 SUSPENSION AIR



Air suspended
Universal forklift seat 48 V
Weight adjustment: 50-140 kg

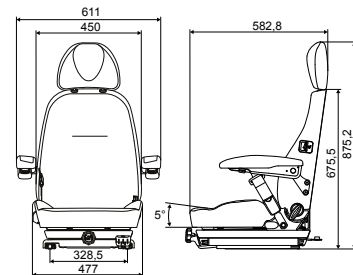

Complete seats

	REF PVC	REF fabric
Seat (48 V) + OPS (switch) heated	144TA5759 *	144TA5763

Accessories

	REF PVC	REF fabric	REF general
Seat cushion + OPS (switch)	147TA3432	147TA3442	
Seat cushion + OPS (switch) + 48 V heating	147TA3434	147TA3438**	
Backrest cushion	147TA3433		
Backrest cushion + 48 V heating	147TA3435	147TA3439**	
Backrest extension	144TA5758	144TA5765	
Headrest	144TA5757	144TA5764	
Armrest kit LH			144TA5760
Armrest kit RH			144TA5762

* Mix PVC/Fabric

**With mechanical lumbar support and document holder



SENTINEL 80 SUSPENSION MECHANICAL



Mechanical suspension

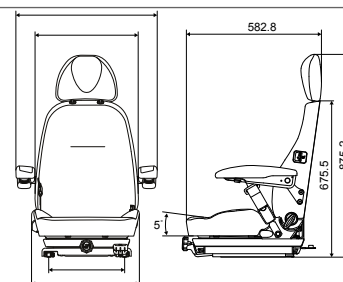

Complete seats

	REF PVC	REF fabric
Seat	144TA5766	144TA5768
Seat + OPS (switch)		144TA5769

Accessories

	REF PVC	REF fabric	REF general
Seat cushion + OPS (switch)	147TA3432	147TA3442	
Seat cushion + OPS (switch) + 48 V heating	147TA3434	147TA3439**	
Backrest cushion	147TA3433		
Backrest cushion + 48 V heating	147TA3435	147TA3439**	
Backrest extension	144TA5758	144TA5765	
Headrest	144TA5757	144TA5764	
Armrest kit LH			144TA5760
Armrest kit RH			144TA5762

* Mix PVC/Fabric

**With mechanical lumbar support and document holder

SENTINEL 80 SUSPENSION AIR



Air suspended seat with lumbar support

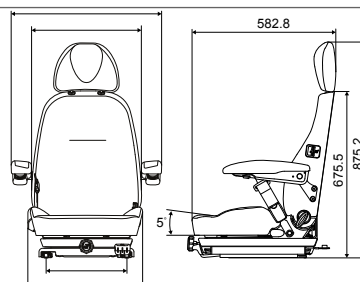

Complete seats

	REF PVC	REF fabric
Seat air suspended (12 V) + OPS (switch)	Not available	144TA5770

Accessories

	REF PVC	REF fabric	REF general
Seat cushion + OPS (switch)	147TA3432	147TA3442	
Seat cushion + OPS (switch) + 48 V heating	147TA3434	147TA3438**	
Backrest cushion	147TA3433		
Backrest cushion + 48 V heating	147TA3435	147TA3439**	
Backrest extension	144TA5758	144TA5765	
Headrest	144TA5757	144TA5764	
Armrest kit LH			144TA5760
Armrest kit RH			144TA5762

* Mix PVC/Fabric

**With mechanical lumbar support and document holder



301



Mechanical suspension
Universal forklift seat
Weight adjustment: 50-120 kg

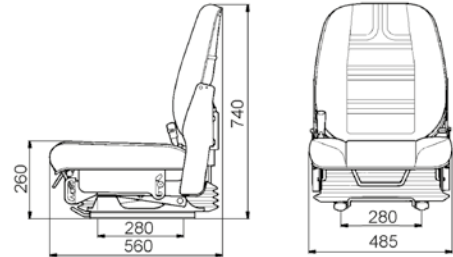

Complete seats

	REF PVC	REF fabric
Seat*	Not available	Not available

Accessories

	REF PVC	REF fabric	REF general
Seat cushion	110TA8904	110TA8905	
Backrest cushion	110TA8906	110TA8907	
Headrest	110TA8908	110TA8909	
Slide rails			110TA8911
Armrest kit			110TA4098
Seat belt (black)			106TA5149
Seat belt (orange)			142TA3335

Obsolete, complete seats till end of stock, spare parts still available till end of stock
*Replacement seat is type 83E1 (page 123)

303



Mechanical suspension
Universal forklift seat
Weight adjustment: 50-120 kg

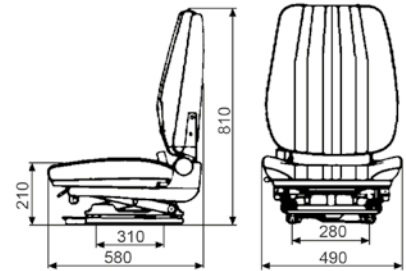

Complete seats

	REF PVC	REF fabric
Seat*	Not available	Not available

Accessories

	REF PVC	REF fabric	REF general
Seat cushion	110TA8924	110TA8925	
Backrest cushion	110TA8926	110TA8927	
Headrest	110TA8928	110TA8929	
Slide rails			110TA8918
Armrest kit			110TA8919
Seat belt (black)			106TA5149
Seat belt (orange)			142TA3335

Obsolete, complete seats till end of stock, spare parts still available till end of stock
*Replacement seat is type 83E1 (page 123)



411



Mechanical suspension
Universal forklift seat
Weight adjustment: 50-120 kg

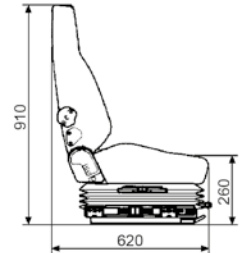
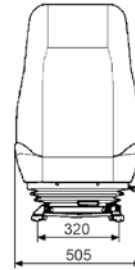

Complete seats

	REF PVC	REF fabric
Seat	144TA5771	110TA8939
Seat + switch	110TA8938	

Accessories

	REF PVC	REF fabric	REF general
Seat cover kit	110TA8940	110TA8941	
Seat foam kit			110TA8942
Backrest cover kit	110TA8943	110TA8944	
Backrest foam kit			110TA8945
Headrest	110TA8953	144TA5358	
Slide rails 280 mm			144TA5772
Slide rails 320 mm			110TA8964
Switch (OPS)			106TA5151
Armrest kit			110TA8949
Seat belt (black)			105TA4857

414



Mechanical suspension
Universal forklift seat
Weight adjustment: 50-120 kg

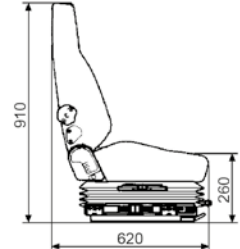
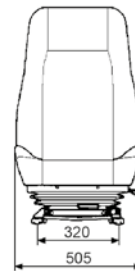

Complete seats

REF PVC

REF fabric

Seat

[110TA8951](#)

Accessories

REF PVC

REF fabric

REF general

Seat cover kit

[128TA4231](#)

[129TA7743](#)

Seat foam kit

[128TA4232](#)

Backrest cover kit

[128TA4233](#)

[129TA7744](#)

Backrest foam kit

[128TA4234](#)

Headrest

[110TA8270](#)

[110TA8971](#)

Slide rails 320 mm

[110TA8964](#)

Switch (OPS)

[110TA8448](#)

Armrest kit

[141TA7803](#)

Seat belt (black)

[141TA7802](#)



711



Universal forklift seat without compressor
Air suspension
Weight adjustment: 50-120 kg

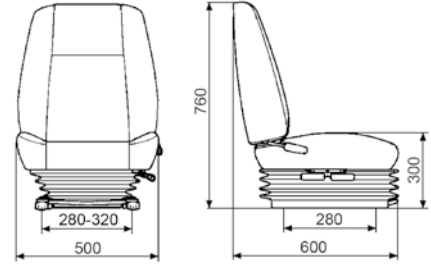

Complete seats

	REF PVC	REF fabric
Seat		110TA8957
Seat (without compressor) + armrests	110TA8956	
Seat (12 V)	110TA8958	110TA8959
Seat (24 V)	111TA4099	111TA4100

Accessories

	REF PVC	REF fabric	REF general
Seat cover kit	110TA8940	110TA8941	
Seat foam kit			110TA8942
Backrest cover kit	110TA8943	110TA8944	
Backrest foam kit			110TA8945
Headrest	110TA8960	144TA5358	
Slide rails 280 mm			144TA5772
Slide rails 320 mm			110TA8964
Switch (OPS)			110TA8962
Armrest kit			110TA8965
Seat belt (black)			105TA4857

714



Universal forklift seat without compressor
Air suspension
Weight adjustment: 50-120 kg

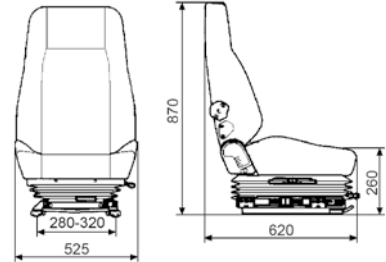

Complete seats

	REF PVC	REF fabric
Seat	110TA8966	110TA8967
Seat (12 V)	110TA8968	110TA8969

Accessories

	REF PVC	REF fabric	REF general
Seat cover kit	128TA4231	129TA7743	
Seat foam kit			128TA4232
Backrest cover kit	128TA4233	129TA7744	
Backrest foam kit			128TA4234
Headrest	110TA8270	110TA8971	
Slide rails 280 mm			144TA5772
Slide rails 320 mm			110TA8964
Switch (OPS)			110TA8936
Armrest kit			141TA7803
Seat belt (black)			141TA7802



716



Air suspension
Universal forklift seat
Weight adjustment: 50-120 kg

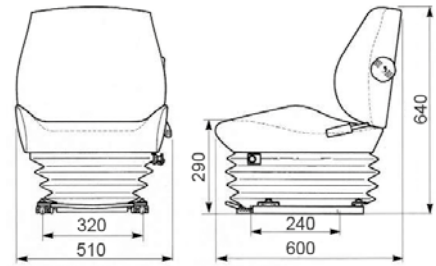

Complete seats

	REF PVC	REF fabric
Seat (12 V)	126TA6076	Not available

Accessories

	REF PVC	REF fabric	REF general
Seat cover kit	126TA6073	128TA4242	
Seat foam kit			116TA6074
Backrest cover kit	144TA5367	129TA7747	
Backrest foam kit			129TA7746
Headrest	129TA7748	144TA5726	
Switch (OPS)			110TA8936
Armrest kit			141TA7803
Seat belt			141TA7802

83E1



Air suspension
 Universal forklift seat with backrest extension
 and armrests
 Weight adjustment: 50-130 kg

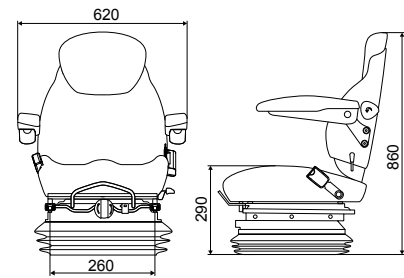

Complete seats

	REF PVC	REF fabric
Seat*	144TA5774	144TA5775

Accessories

	REF PVC	REF fabric	REF general
Seat cover kit	147TA3449	144TA5779	
Seat foam kit			144TA3668
Backrest cover kit	147TA3450	144TA5780	
Backrest foam kit			144TA5734
Backrest extension	144TA5732	147TA3405	
Slide rails			144TA5777
Switch (OPS)			106TA5151
Armrest kit			141TA7803
Seat belt (black)			144TA5776

*Replaces the KAB 301 (page116) & KAB 303 (page 117)



85E6 (KAB BY TVH)



Air suspended seat
Weight adjustment: 50-120 kg
Used on JCB: agriculture and construction

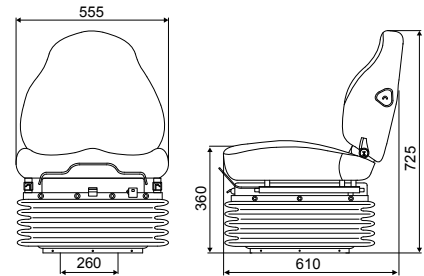

Complete seats

	REF PVC	REF fabric
Seat (12 V)	Not available	141TA7730

Accessories

	REF PVC	REF fabric	REF general
Seat cover kit	144TA5730	144TA3667	
Seat foam kit			144TA3668
Backrest cover kit	144TA5731	144TA3669	
Backrest foam kit			144TA3670
Backrest extension	144TA5732	141TA7759*	
Slide rails			144TA3671
Switch (OPS)			110TA8932
Armrest kit			141TA7803
Seat belt (black)			141TA7802

*Totalsource headrest

85K6



Air suspended seat
 Features: heating, electrical lumbar support,
 seat length and tilt adjustment
 Weight adjustment: 50-120 kg
 Used in agriculture

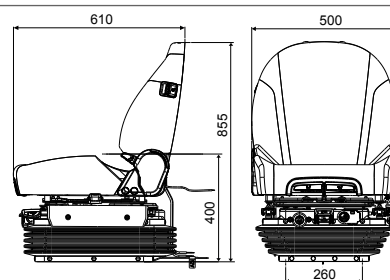

Complete seats

	REF PVC	REF fabric
Seat (12 V) + heating	Not available	141TA7729
Seat (24 V) + heating	Not available	143TA7532

Accessories

	REF PVC	REF fabric	REF general
Seat cushion cover	144TA5781	144TA3672	
Seat cushion foam			144TA3673
Backrest cushion cover	144TA5782	144TA3674	
Backrest cushion foam			144TA3675
Backrest extension	144TA5732	141TA7759*	
Slide rails			144TA3677
Switch (OPS)			144TA3676
Armrest kit			141TA7801
Retractable seat belt			141TA7802

*Totalsource headrest



NOTES

NOTES

A large area for taking notes, featuring horizontal dotted lines on a light gray background. The background has a white curved shape at the bottom.



2.4

ISRI

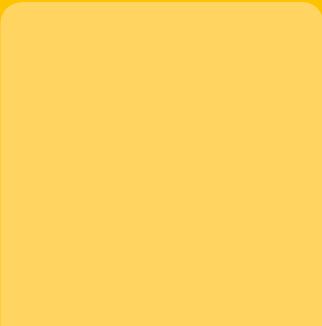



ISRI 2300 LR



Mechanical suspension
 Universal forklift seat
 Weight adjustment: 50-130 kg
 Also available with heating see [147TA3381]
 Used on Still

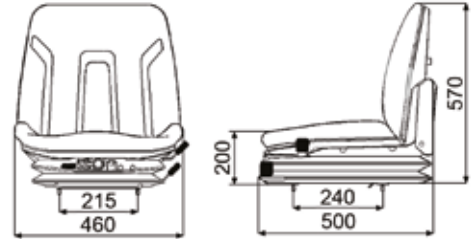

Complete seats

	REF PVC	REF fabric
Seat	106TA8607	
Seat + switch (OPS)	110TA8858	
Seat + seat belt*	110TA8860	110TA8861
Seat + seat belt + switch (OPS)*	110TA8862	110TA8863

Accessories

	REF PVC	REF fabric	REF general
Seat cushion	110TA8622	110TA8866	
Backrest cushion	128TA4209	110TA8868	
Headrest	110TA8869		
Retractable seat belt			106TA5149
Switch (OPS)			110TA8658
Armrest kit			110TA8871

* Slide rails at 328 mm instead of 215 mm

ISRI 2300 MR (NARROW)



Mechanical suspension
 Universal forklift seat
 Weight adjustment: 50-130 kg
 Also available with heating (REF 147TA3381)
 Used on Still

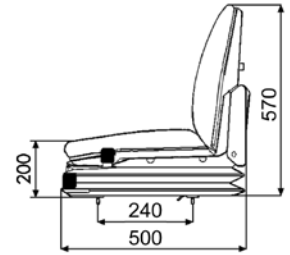
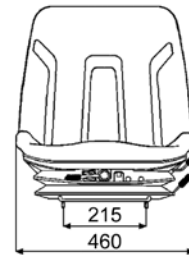

Complete seats

	REF PVC	REF fabric
Seat	106TA8605	110TA8651
Seat + switch (OPS)	110TA8652	110TA8653
Seat + seat belt + switch (OPS)*	129TA8516	129TA8517

Accessories

	REF PVC	REF fabric	REF general
Seat cushion	110TA8654	110TA8655	
Backrest cushion	110TA8656	110TA8657	
Headrest	110TA8869		
Retractable seat belt*			106TA5149
Switch (OPS)			110TA8658

* In combination with [106TA5154](#) (much wider)



ISRI 6000/516



Mechanical suspension
 Universal forklift seat
 Weight adjustment: 40-130 kg
 Used on Still

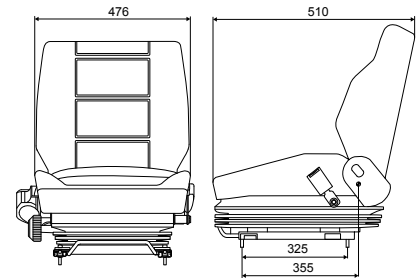

Complete seats

	REF PVC	REF fabric
Seat	139TA6074	Not available
Seat + seat belt	145TA9020	Not available

Accessories

	REF PVC	REF fabric	REF general
Seat cushion	145TA9021	Not available	
Backrest cushion	145TA9022	Not available	
Headrest	147TA3382	Not available	
Retractable seat belt			147TA3383
Switch (OPS)			
Armrest LH			147TA3384
Armrest RH			147TA3385

ISRI 6000/575



Mechanical suspension
 Universal forklift seat
 Weight adjustment: 40-130 kg

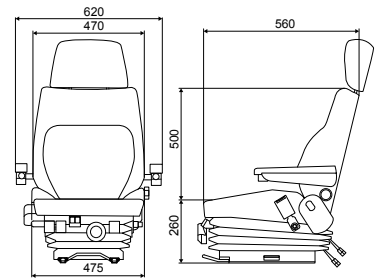

Complete seats

	REF PVC	REF fabric
Seat front controls		145TA9023
Seat side controls	139TA6076	

Accessories

	REF PVC	REF fabric	REF general
Seat cushion	147TA3386	140TA8275	
Backrest cushion	145TA9025	145TA9024	
Headrest	147TA3382	147TA3388	
Retractable seat belt			147TA3383
Armrest LH			147TA3384
Armrest RH			147TA3385



ISRI 6000/577



Mechanical suspension
 Universal forklift seat
 Weight adjustment: 40-130 kg

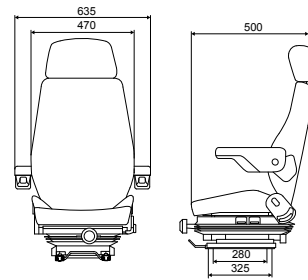

Complete seats

	REF PVC	REF fabric
Seat front controls		145TA9026
Seat side controls		140TA8274

Accessories

	REF PVC	REF fabric	REF general
Seat cushion	147TA3386	140TA8275	
Backrest cushion	145TA9025	147TA3389	
Headrest	147TA3382	147TA3388	
Retractable seat belt			147TA3383
Armrest LH			147TA3390
Armrest RH			147TA3391

ISRI 6500/517



Air suspension
 Universal construction seat
 Weight adjustment: 50-130 kg

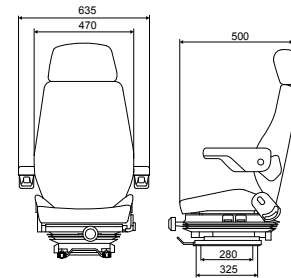

Complete seats

	REF PVC	REF fabric
Seat	147TA3392	145TA9027

Accessories

	REF PVC	REF fabric	REF general
Seat cushion	147TA3386	140TA8275	
Backrest cushion	147TA3393	147TA3394	
Headrest	147TA3382	147TA3388	
Retractable seat belt			147TA3383
Armrest LH			147TA3390
Armrest RH			147TA3391



ISRI 6500KM/345



Air suspended construction seat 24 V with heating
 Weight adjustment: 50-130 kg
 Used on Volvo

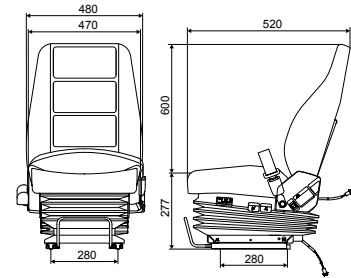

Complete seats

	REF PVC	REF fabric
Seat + seat belt	Not available	145TA9028

Accessories

	REF PVC	REF fabric	REF general
Seat cushion with heating	Not available	145TA9029	
Backrest cushion with heating	Not available	145TA9030	
Headrest	Not available		
Retractable seat belt			145TA9031
Armrest LH			147TA3384
Armrest RH			147TA3385



ISRI 6500KM/348



24 V air suspended construction seat with heating
 Weight adjustment: 50-130 kg
 Used on Kalmar

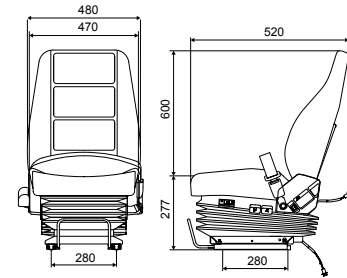

Complete seats

	REF PVC	REF fabric
Seat heated	Not available	145TA9032

Accessories

	REF PVC	REF fabric	REF general
Seat cushion with heating	Not available	147TA3395	
Backrest cushion with heating	Not available	147TA3396	
Headrest	Not available	147TA3388	
Retractable seat belt			147TA3383
Armrest LH			147TA3384
Armrest RH			147TA3385



ISRI 6500KM/575



Air suspended construction seat 24 V
Weight adjustment: 50-130 kg
Used on Linde

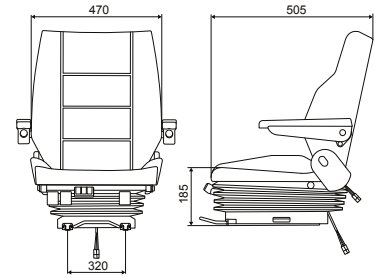

Complete seats

REF PVC

REF fabric

Seat

[145TA9033](#)

Accessories

REF PVC

REF fabric

REF general

Seat cushion

[147TA3386](#)

[140TA8275](#)

Backrest cushion

[145TA9025](#)

[145TA9024](#)

Headrest

[147TA3382](#)

[147TA3388](#)

Retractable seat belt

[147TA3383](#)

Armrest LH

[147TA3390](#)

Armrest RH

[147TA3391](#)



ISRI 6500KM/577



Air suspended construction seat 24 V
Weight adjustment: 50-130 kg
Used on Volvo

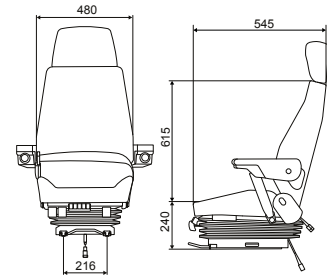

Complete seats

	REF PVC	REF fabric
Seat 24 V		139TA6078

Accessories

	REF PVC	REF fabric	REF general
Seat cushion	147TA3386	140TA8275	
Backrest cushion	145TA9025	147TA3389	
Headrest	147TA3382	147TA3388	
Retractable seat belt			147TA3383
Armrest LH			147TA3390
Armrest RH			147TA3391



NOTES

NOTES

A large area for taking notes, featuring horizontal dotted lines on a light gray background. The background has a white curved shape at the bottom.



2.5

SEARS





1200 SERIES



Mechanical suspended seat
Weight adjustment: 30-130 kg
Used on Hyster/Yale

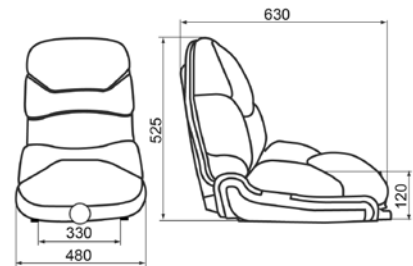

Complete seats

	REF PVC	REF fabric
Seat	111TA6588	
Seat + switch (OPS)	111TA6590	
Seat + switch (OPS) + seat belt	147TA3014	
Seat + switch (OPS) + armrests	150TA9830	126TA6045
Seat + switch (OPS) + seat belt + armrests	111TA6593	

Accessories

	REF PVC	REF fabric	REF general
Seat cushion	111TA6594	111TA6595	
Seat cushion	128TA4185	147TA3015	
Seat cushion	128TA4186	147TA3016	
Backrest cushion	111TA6596	111TA6597	
Retractable seat belt			106TA5149
Switch (OPS)			111TA6598
Slide rails			111TA6599
Arm rest kit			126TA6046
Document holder			128TA4184

Without mounting (REF [111TA6594](#) - REF [111TA6595](#))
With bracket and mounting clips (REF [128TA4185](#) - REF [147TA3015](#))
With mounting clips (REF [128TA4186](#) - REF [147TA3016](#))



REF [111TA6594](#) - REF [111TA6595](#)



REF [128TA4185](#) - REF [147TA3015](#)



REF [128TA4186](#) - REF [147TA3016](#)



1500 SERIES



Mechanical suspended seat
Weight adjustment: 30-130 kg
Used on Hyster/Yale

Complete seats

	REF PVC	REF fabric
Seat + switch (OPS)	<u>147TA5006</u>	
Seat + seat belt + switch (OPS) + armrest	<u>125TA6317</u>	<u>125TA6318</u>

Accessories

	REF PVC	REF fabric	REF general
Seat cushion	<u>144TA3678</u>	<u>144TA3679</u>	
Seat cushion + switch (OPS)	<u>125TA6319</u>	<u>125TA6320</u>	
Backrest cushion	<u>125TA6321</u>	<u>125TA6322</u>	
Retractable seat belt			<u>106TA5149</u>
Slide rails			<u>125TA6326</u>
Arm rest			<u>126TA6052</u>



1700 SERIES



Mechanical suspended seat
Weight adjustment: 30-130 kg
Used on Hyster/Yale

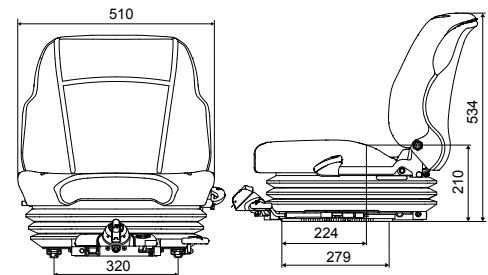

Complete seats

	REF PVC	REF fabric
Seat + switch	147TA5002	
Seat + switch + doc holder	147TA3017	147TA3020

Accessories

	REF PVC	REF fabric	REF general
Seat cushion + switch (OPS)	147TA3018	145TA8891	
Backrest cushion	147TA3019	147TA3021	
Retractable seat belt			108TA4228
Switch (OPS)			140TA1737
Slide rails			147TA3022
Arm rest RH			147TA3023
Arm rest LH			147TA3024



2.6

KLEPP



KLEPP



Suspension seat with weight adjustment and slide rails.
Weight: 17,4 kg

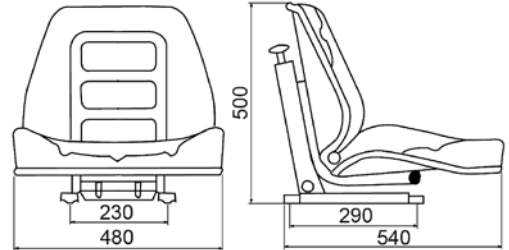

Complete seats

	REF PVC	REF fabric
Seat	110TA8832	
Seat with safety switch	123TA7540	

Accessories

	REF PVC	REF fabric	REF general
Seat cushion	110TA8834	110TA8835	
Seat cushion with safety switch	110TA8836	110TA8837	
Back rest cushion	110TA8838	110TA8839	
Headrest	110TA8840	110TA8841	
Slide rails			123TA7541
Static seat belt			105TA4859
Retractable seat belt			106TA5149
Retractable seat belt			110TA8768
Seat belt bracket *			106TA5154
Armrest kit			110TA8842

* Necessary for fixing a belt on the seat

KLEPP

We can also provide seats equipped with options



KLEPP



Non suspension seat with slide rails
Weight: 10 kg

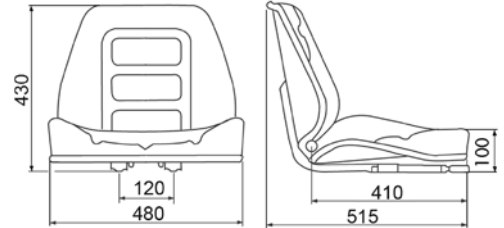

Complete seats

	REF PVC	REF fabric
Seat	110TA8820	110TA8821
Seat with safety switch	110TA8822	

Accessories

	REF PVC	REF fabric	REF general
Seat cushion	110TA8823	110TA8824	
Seat cushion with safety switch	110TA8825	110TA8826	
Back rest cushion	110TA8827	110TA8828	
Headrest	110TA8829	110TA8830	
Armrest kit			110TA8831

KLEPP

We can also provide seats equipped with options



KLEPP (NARROW)



Non suspension seat with slide rails
Special seat for reach truck
Weight: 9 kg

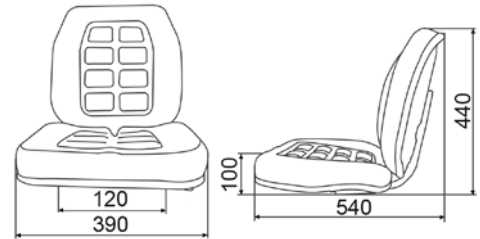

Complete seats

REF PVC

REF fabric

Seat

[110TA8659](#)

Seat with safety switch

[110TA8660](#)

Accessories

REF PVC

REF fabric

REF general

Seat cushion

[123TA7531](#)

Seat cushion with safety switch

[123TA7643](#)

Back rest cushion

[123TA7532](#)

KLEPP

We can also provide seats equipped with options



2.7

COBO

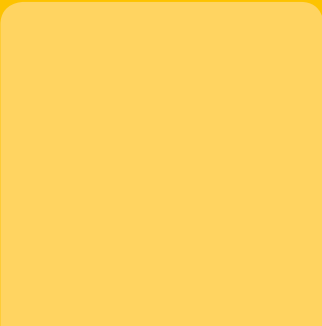



PS48



Universal seat pan with slide rails

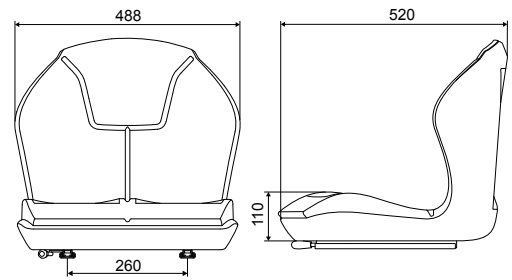

Complete seats

REF PVC

REF fabric

Seat pan + switch (OPS)

[125TA6328](#)

Accessories

REF PVC

REF fabric

REF general

Switch (OPS)

[110TA9013](#)

Slide rails

[145TA2750](#)



We can also provide seats equipped with options



GT62



Universal seat pan with slide rails
With drain hole
Used on Hyster/Yale

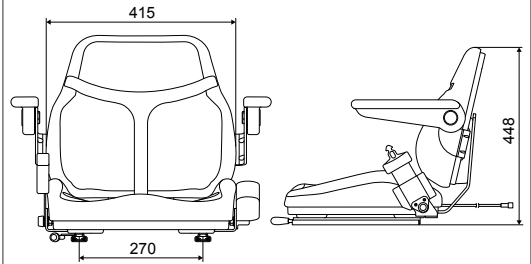

Complete seats

REF PVC

REF fabric

Seat pan

[145TA2751](#)

Accessories

REF PVC

REF fabric

REF general

Slide rails

[145TA2750](#)



We can also provide seats equipped with options



SC76



Universal non suspended seat top with headrest, armrests, switch (OPS) and seat belt
Used on OMG

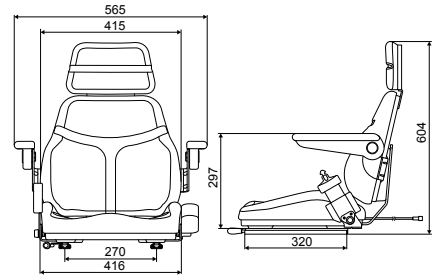

Complete seats

	REF PVC	REF fabric
Seat + switch (OPS) + seat belt	145TA2758	Not available

Accessories

	REF PVC	REF fabric	REF general
Seat cushion + switch (OPS)	145TA9272	Not available	
Backrest cushion	145TA9273	Not available	
Headrest	145TA9278	Not available	
Retractable seat belt			145TA9275
LH armrest			145TA9276
RH armrest			145TA9277



We can also provide seats equipped with options



SC74/M20



Universal forklift seat
Mechanical suspension
Weight adjustment: 50-120 kg

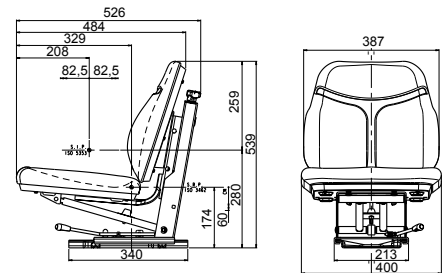

Complete seats

REF PVC

REF fabric

Seat

[144TA3654](#)

Seat + OPS (switch)

[145TA2826](#)

Accessories

REF PVC

REF fabric

REF general

Seat cushion

[144TA3655](#)

Backrest cushion

[144TA3656](#)



SC47/M99



Universal forklift seat with static seat belt and headrest
 Mechanical suspension
 Weight adjustment: 50-120 kg
 Used on Ausa

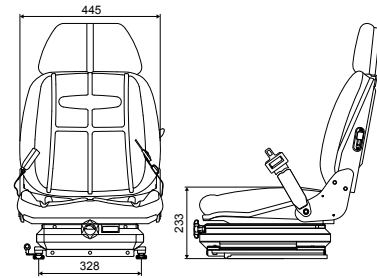

Complete seats

REF PVC

REF fabric

Seat + seat belt

[145TA2837](#)

Accessories

REF PVC

REF fabric

REF general

Seat cushion

[145TA9367](#)

Backrest cushion

[145TA9368](#)

Headrest

[145TA9370](#)

Static seat belt

[145TA9369](#)



We can also provide seats equipped with options



SC90/M97



Mechanical suspended seat with seat belt
Weight adjustment: 50-130 kg
Used on Merlo

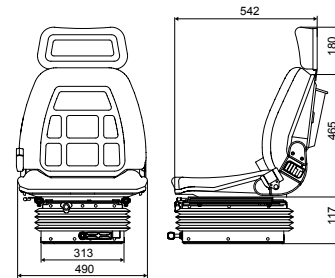

Complete seats

REF PVC

REF fabric

Seat + seat belt

[145TA2841](#)

Accessories

REF PVC

REF fabric

REF general

Seat cushion

[145TA9371](#)

Backrest cushion

[145TA9372](#)

Headrest

[145TA9375](#)

Retractable seat belt

[106TA5147](#)



SC90/M293



Mechanical suspended seat with seat belt
Weight adjustment: 50-120 kg
Used on JLG

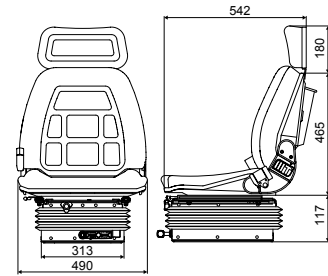

Complete seats

REF PVC

REF fabric

Seat + seat belt

[145TA2847](#)

Accessories

REF PVC

REF fabric

REF general

Seat cushion

[145TA9376](#)

Backrest cushion

[145TA9377](#)

Headrest

[145TA9275](#)

Retractable seat belt

[145TA9275](#)



We can also provide seats equipped with options



SC95/M91



Mechanical suspended seat with seat belt
Weight adjustment: 50-120 kg
Used on Genie/Terex

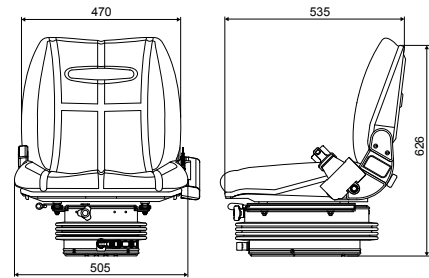

Complete seats

REF PVC

REF fabric

Seat + seat belt

[145TA9378](#)

Accessories

REF PVC

REF fabric

REF general

Seat cushion

[145TA9382](#)

Backrest cushion

[145TA9383](#)

Retractable seat belt

[106TA5147](#)



We can also provide seats equipped with options



NOTES

NOTES

A large area for taking notes, featuring horizontal dotted lines on a light gray background. The background has a white curved shape at the bottom.



2.8

BE-GE



BE-GE 80-16



Small forklift seat with switch and headrest
 Mechanical suspension
 Weight adjustment: 60-130 kg
 Used on BT

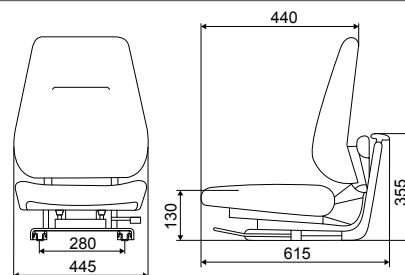

Complete seats

	REF PVC	REF fabric
Seat + switch	147TA4103	136TA1183

Accessories

	REF PVC	REF fabric	REF general
Seat cushion	147TA4377	147TA4318	
Backrest cushion	147TA4317	147TA4378	
Headrest	147TA4379	147TA4320	
Switch (OPS)			145TA9974



We can also provide seats equipped with options



BE-GE 80-17 (SEAT BACK TILTABLE 15 DEGREES)



Small forklift seat with switch, headrest, tiltable 15 degrees back and LH controls
 Mechanical suspension
 Weight adjustment: 60-130 kg
 Used on BT

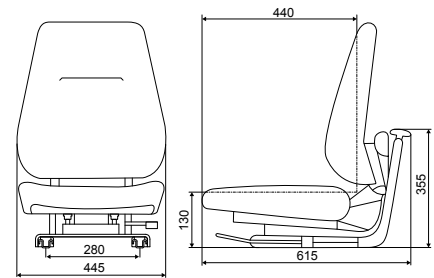

Complete seats

	REF PVC	REF fabric
Seat + switch	147TA4380	147TA4381*

Accessories

	REF PVC	REF fabric	REF general
Seat cushion	147TA4382	147TA4383*	
Backrest cushion	147TA4384	147TA4386	
Headrest	147TA4379	147TA4386*	
Switch (OPS)			145TA9974

* Fabric: GN black



We can also provide seats equipped with options



BE-GE 80-18A HB (HIGH BACK)



Small forklift seat with switch and headrest
 Mechanical suspension
 Weight adjustment: 60-130 kg
 Used on BT

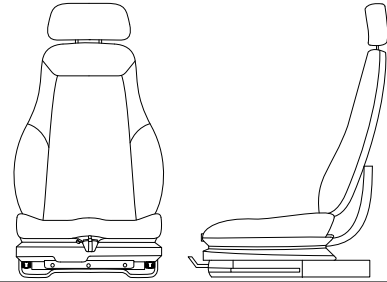

Complete seats

	REF PVC	REF fabric
Seat + switch	147TA4388	147TA4344*

Accessories

	REF PVC	REF fabric	REF general
Seat cushion without tilt (Not for 80-18 A)	147TA4400	147TA4321*	
Seat cushion with tilt	147TA4525	147TA4526*	
Backrest cushion	147TA4535	147TA4322*	
Headrest	147TA4542	147TA4543*	
Switch (OPS) set			147TA4325
Switch only			110TA8981
Armrest pair (LH + RH)/incl. bracket			147TA4556
Armrest Bar kit (bracket)			147TA4328
Retractable seat belt set			147TA4323
Belt only			147TA4324

* Fabric: Nightfall



We can also provide seats equipped with options



BE-GE 80-18A LB (LOW BACK)



Small forklift seat with switch and headrest
 Mechanical suspension
 Weight adjustment: 60-130 kg
 Used on BT

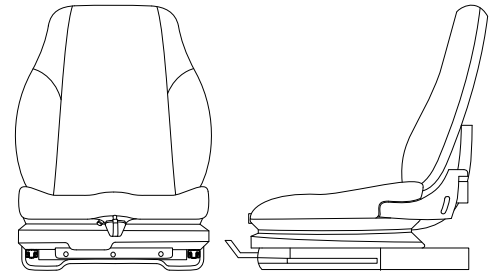

Complete seats

REF PVC

REF fabric

Seat + switch

[147TA4390*](#)

Accessories

REF PVC

REF fabric

REF general

Seat cushion without tilt (Not for 80-18 A)

[147TA4400](#)

[147TA4321*](#)

Seat cushion with tilt

[147TA4525](#)

[147TA4526*](#)

Backrest cushion

[150TA9665](#)

[147TA4536*](#)

Switch (OPS) set

[147TA4325](#)

Switch only

[110TA8981](#)

Armrest pair (LH + RH)/incl. bracket

[147TA4556](#)

Armrest Bar kit (bracket)

[147TA4328](#)

Retractable seat belt set

[147TA4323](#)

Belt only

[147TA4324](#)

* Fabric: Nightfall



BE-GE 81-16 WIDE CUSHIONS



Universal forklift seat with switch and prepared for headrest
 Mechanical suspension
 Weight adjustment: 60-130 kg

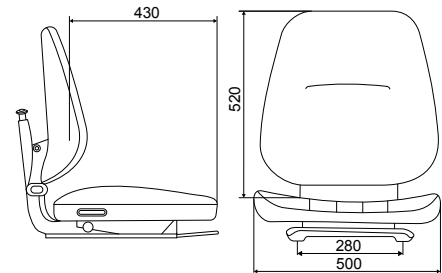

Complete seats

	REF PVC	REF fabric
Seat + switch	147TA4392	147TA4394*

Accessories

	REF PVC	REF fabric	REF general
Seat cushion	147TA4519	147TA4522*	
Backrest cushion	147TA4527	147TA4537*	
Headrest	147TA4544	147TA4545*	
Switch (OPS)			145TA9974
Armrest set			147TA4549
Retractable seat belt incl. mounting kit			147TA4329

* Fabric: GN black



We can also provide seats equipped with options



BE-GE 81-36 WIDE CUSHIONS



Universal forklift seat with switch
Mechanical suspension
Weight adjustment: 50-150 kg

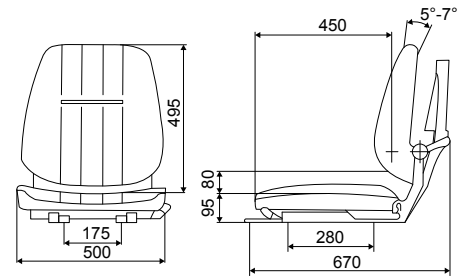

Complete seats

	REF PVC	REF fabric
Seat + switch	NLA	NLA

Accessories

	REF PVC	REF fabric	REF general
Seat cushion RH	147TA4520	147TA4523*	
Backrest cushion	147TA4538	147TA4539*	
Switch (OPS)			110TA8981
Armrest fixed set			147TA4549

* Fabric: GN black



We can also provide seats equipped with options



BE-GE 84-16 NARROW CUSHIONS



Small forklift seat with switch
Mechanical suspension
Weight adjustment: 50-150 kg

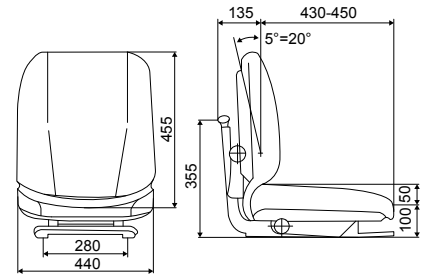

Complete seats

	REF PVC	REF fabric
Seat + switch	147TA4393	147TA4395*

Accessories

	REF PVC	REF fabric	REF general
Seat cushion	147TA4521	147TA4524*	
Backrest cushion	147TA4540	147TA4541*	
Switch (OPS)			145TA9974
Retractable seat belt incl. mounting kit			147TA4329

* Fabric: GN black



We can also provide seats equipped with options

BE-GE 92-00



Universal forklift construction seat
 Seat back height: 640 mm
 Mechanical suspension
 Weight adjustment: 50-150 kg
 Used on Kalmar

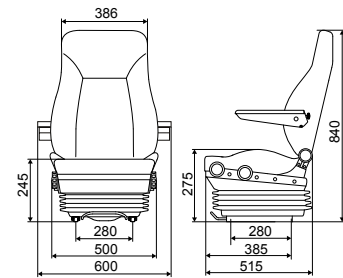

Complete seats

	REF PVC	REF fabric
Seat back	147TA4352	147TA4353*
Seat with 3-point seat belt Left	147TA4396	147TA4397 *
Seat + RH armrest		139TA6057*
Seat with switch (OPS), RH armrest and buzzer		147TA4398*
Seat with armrests, headrest and 3-point seat belt Left		147TA4515*
Seat with armrests, headrest and 4-point seat belt		147TA4399*

Accessories

	REF PVC	REF fabric	REF general
Seat cushion cover	147TA4330	144TA3691*	
Seat cushion cover + Seat foam without contact plate		147TA4332*	
Seat cushion foam with contact plate			147TA4333
Backrest cushion	147TA4334	144TA3692*	
Headrest 2-way	147TA4557	147TA4335*	
Switch (OPS)			147TA4338
Armrest kit wide			147TA4359
Slide rail kit (standard, no belt)			147TA4339
Protection cover backrest on cloth with PVC sidewings			147TA4562
seat belt mounting kit			147TA4563
3-point seat belt left			139TA6068
4-point seat belt			147TA4337
Retractable 2-point seat belt			147TA4336

* Fabric: GN black



BE-GE 91-00



Universal forklift construction seat
Air suspension
Weight adjustment: 50-150 kg
Used on Kalmar

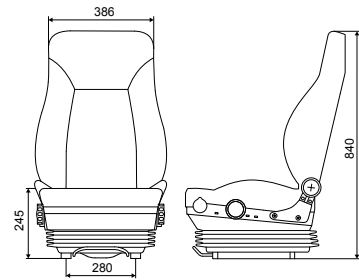

Complete seats

	REF PVC	REF fabric
Seat with 12 V compressor		147TA4617*
Seat with 24 V compressor		147TA4362 *
Seat (without compressor)	147TA4615	147TA4361*
Seat (without compressor)**		147TA4616*

Accessories

	REF PVC	REF fabric	REF general
Seat cushion cover	147TA4330	144TA3691*	
Seat cushion cover + Seat foam without contact plate		147TA4332*	
Seat cushion foam with contact plate			147TA4333
Backrest cushion	147TA4334	144TA3692*	
Headrest 2-way	147TA4557	147TA4335*	
Switch (OPS)			147TA4338
Armrest kit wide			147TA4359
Slide rail kit (standard, no belt)			147TA4339
Protection cover backrest on cloth with PVC sidewings			147TA4562
seat belt mounting kit			147TA4563
3-point seat belt left			139TA6068
4-point seat belt			147TA4337
Retractable 2-point seat belt			147TA4336

* Fabric: GN black

** With headrest and armrests



2.9

MILSCO





XB180



Universal seat pan
Used on tail mounted trucks and cleaning machines (JCB/Moffet)
With drain hole

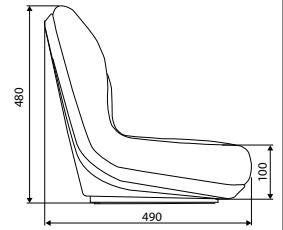
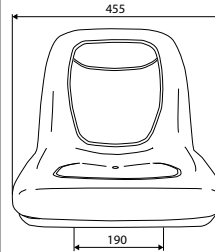

Complete seats

	REF PVC	REF fabric
Seat pan	135TA2792	Not available
Seat pan Yellow	144TA3666	Not available
Seat pan with slide rails	136TA8305	Not available

Accessories

	REF PVC	REF fabric	REF general
Switch (OPS)			139TA7214
Slide rails			110TA8751



We can also provide seats equipped with options



XB200



Universal seat pan
Used on tail mounted trucks and cleaning machines (JCB/Doosan)
With drain hole

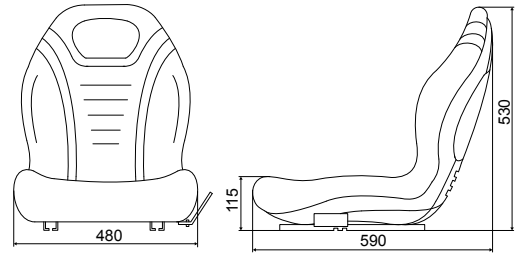

Complete seats

	REF PVC	REF fabric
Seat pan	139TA6025	Not available
Seat pan with slide rails	144TA5387	Not available

Accessories

	REF PVC	REF fabric	REF general
Switch (OPS)			139TA7214
Slide rails			144TA5388



We can also provide seats equipped with options



CR100/M60



Universal forklift seat
 Mechanical suspension
 Weight adjustment: 50-130 kg
 Used on JCB

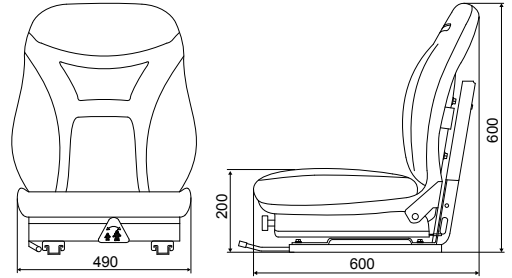

Complete seats

	REF PVC	REF fabric
Seat	147TA3007	147TA3008



We can also provide seats equipped with options



CE200/M60



Universal forklift seat
Mechanical suspension
Weight adjustment: 50-120 kg

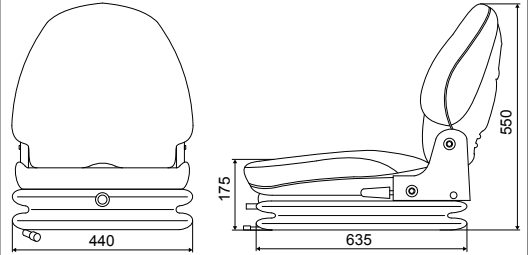

Complete seats

REF PVC

REF fabric

Seat

[147TA3009](#)

Accessories

REF PVC

REF fabric

REF general

Seat cushion

[147TA3010](#)

Backrest cushion

[147TA3011](#)

Retractable seat belt

[106TA5147](#)

Slide rails

[147TA3012](#)

Arm rest kit

[147TA3013](#)



We can also provide seats equipped with options



NOTES

NOTES

A large area for taking notes, featuring horizontal dotted lines on a light gray background. The background has a white curved shape at the bottom.



2.10

ANTI-STATIC SEATS





ES12 (FABRIC)

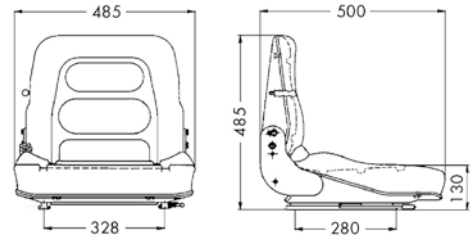

REF [123TA7530](#)

TOTALSOURCE®

MSG 20 (FABRIC)

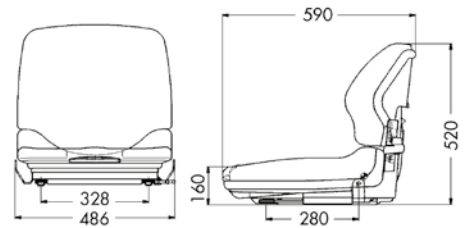

REF [129TA7755](#)

GRAMMER

KAB 211 (FABRIC)

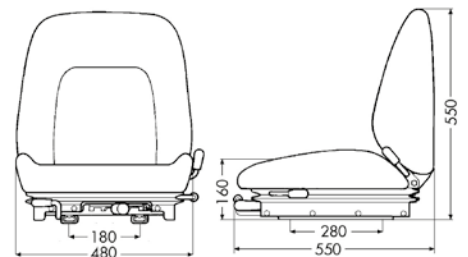

REF [110TA8882](#)

KAB//Seating



2.11

HEATED SEATS



MSG 20

	REF PVC	REF fabric
Seat 12 V	129TA7771	129TA7781
Seat 24 V	129TA7772	147TA5061
Seat 24 V & Switch	129TA7773	129TA7783
Seat 48 V & Switch	129TA7774	129TA7784
Seat cushion 12 V/24 V	129TA7775	129TA7785
Seat cushion set 48 V	141TA4946	141TA4944
Seat cushions set 12/24V	141TA4945	141TA4943
For specifications see page 63		



MSG 20 NARROW

	REF PVC	REF fabric
Seat 12 V	129TA7738	
Seat 24 V	128TA4158	
Seat 48 V	128TA4159	
For specifications see page 64		



MSG75/731

	REF PVC	REF fabric
Seat 12 V	147TA4986	
For specifications see page 73		



TS6



REF PVC REF fabric

Seat 12 V

[147TA4985](#)

For specifications see page 94

KAB//Seating

KAB 211



REF PVC REF fabric

Seat + switch 12 V

[151TA2489](#)

Seat 24 V

[151TA2490](#)

Seat + seat belt 24 V

[151TA2894](#)

Seat 48 V

[151TA2895](#)

Seat + switch 48 V

[147TA4983](#)

See chapter consumables for accessories

For specifications see page 106

KAB//Seating



NOTES

NOTES

A large area for taking notes, featuring horizontal dotted lines on a light gray background. The background has a white curved shape at the bottom.



2.12

NARROW SEATS



MSG 20 NARROW

	REF PVC	REF new fabric
Seat	<u>110TA8633</u>	<u>147TA4633</u>
Seat + switch (OPS)	<u>110TA8635</u>	<u>144TA3683</u>
Seat + seat belt	<u>110TA8637</u>	<u>147TA5079</u>
Seat + seat belt + switch (OPS)	<u>110TA8639</u>	<u>145TA2602</u>
Seat + switch + heating 12 V	<u>129TA7738</u>	
Seat + switch + heating 24 V	<u>128TA4158</u>	
Seat + switch + heating 48 V	<u>128TA4159</u>	
For specifications see page 64		



ISRI 2300 NARROW

	REF PVC	REF fabric
Seat	<u>106TA8605</u>	<u>110TA8651</u>
Seat with safety switch	<u>110TA8652</u>	<u>110TA8653</u>
Seat with safety switch + retractable seat belt	<u>129TA8516</u>	<u>129TA8517</u>
For specifications see page 129		



KLEPP NARROW VERSION

	REF PVC	REF fabric
Seat	<u>110TA8659</u>	
Seat with safety switch	<u>110TA8660</u>	
For specifications see page 146		





KLEPP NARROW VERSION



	REF PVC	REF fabric
Seat		110TA8663
Seat with safety switch		110TA8665
For specifications see page 144		

KAB XH2/P1



	REF PVC	REF fabric
Seat		147TA3398
For specifications see page 95		

KAB//Seating

TOTALSOURCE TS2460/ES200



	REF PVC	REF fabric
Seat		Not available
Seat with switch		Not available
For specifications see page 50		

TOTALSOURCE®



NOTES

NOTES

A large area for taking notes, featuring horizontal dotted lines on a light gray background. The background has a white curved shape at the bottom.



2.13

SEATS FOR SPECIFIC MAKES



SEATS FOR SPECIFIC MAKES



***Seats for specific makes on request.
These are determined on the basis of truck type or OEM-reference.***

Specific seats (make-related, type-related ...) can be identified and/or requested via My PartsFinder (search by brand and truck type) and My ProductSearch (search by specifications/technical info).
For more information about MPF and PS see our Nice to know document. (Page 4 & 5)

MyTotalSource

Your interactive online webshop
for spare parts





3

ACCESSORIES



STATIC SEAT BELT



REF [142TA3333](#) – Orange webbing

REF [110TA8685](#) – Black webbing

Characteristics:

- Static seat belt
- Twin release buckle on rigid bracket 15 cm
- Full extended overall length 119 cm
- Approved to SAE J386/ECE R16



STATIC SEAT BELT



REF [147TA3648](#) – Black webbing

Characteristics:

- Static seat belt
- Buckle on Webbing with Anchor 22 cm
- Full extended overall length 123 cm
- Approved to SAE J386/ECE R16





ALR SEAT BELT



REF [143TA7594](#) – Orange webbing

REF [144TA8794](#) – Black webbing

Characteristics:

- ALR (Automatic Locking Retractor)
- Twin release buckle on rigid bracket 10 cm
- Full extended overall length 128 cm
- Approved ECE R16, SAE J386 & FMVSS 302



ALR SEAT BELT



REF [126TA6069](#) – Orange webbing

REF [106TA5147](#) – Black webbing

Characteristics:

- ALR (Automatic Locking Retractor)
- Twin release buckle on rigid bracket 15 cm
- Full extended overall length 128 cm
- Approved ECE R16, SAE J386 & FMVSS 302





ALR SEAT BELT



REF 143TA7595 – Orange webbing

REF 105TA4857 – Black webbing

Characteristics:

- ALR (Automatic Locking Retractor)
- Twin release buckle on Webbing with Anchor 22 cm (with sleeve)
- Full extended overall length 128 cm
- Approved ECE R16, SAE J386 & FMVSS 302



ALR SEAT BELT



REF 142TA3335 – Orange webbing

REF 106TA5149 – Black webbing

Characteristics:

- ALR (Automatic Locking Retractor)
- Twin release buckle on Flexible Sleeve 25 cm with elasticated extension up to 4 cm
- Full extended overall length 114 cm
- For use on suspension seat
- Approved SAE J386 & FMVSS 302





ALR SEAT BELT



REF [147TA3649](#) – Black webbing

Characteristics:

- ALR (Automatic Locking Retractor)
- Twin release buckle on flexible stalk 25 cm
- Full extended overall length 112 cm
- Approved ECE R16, DIR 77/541, SAE J386 & FMVSS 302



ALR SEAT BELT



REF [147TA3650](#) – Black webbing

Characteristics:

- ALR (Automatic Locking Retractor) on webbing strap
- Buckle on Webbing with Anchor 22 cm
- Full extended overall length 128 cm
- Approved ECE R16, SAE J386 & FMVSS 302





ALR SEAT BELT



REF [147TA3651](#) – Black webbing

Characteristics:

- ALR (Automatic Locking Retractor)
- Twin release buckle on rigid bracket 10 cm
- Full extended overall length 128 cm
- Approved ECE R16, SAE J386 & FMVSS 302
- Buckle with integral micro switch (3 wire) IP 67 rated, switch black/blue = normal open, black/red= normal closed



ALR SEAT BELT



REF [126TA6068](#) – Orange webbing

REF [110TA8613](#) – Black webbing

REF [129TA9154](#) – Yellow webbing

Characteristics:

- ALR (Automatic Locking Retractor)
- Twin release buckle on rigid bracket 15 cm
- Full extended overall length 128 cm
- Approved ECE R16, SAE J386 & FMVSS 302
- Buckle with integral micro switch (3 wire) IP 67 rated, switch black/blue = normal open, black/red= normal closed





ALR SEAT BELT



REF [147TA3652](#) – Orange webbing

REF [147TA3653](#) – Black webbing

Characteristics:

- ALR (Automatic Locking Retractor)
- Twin release buckle on flexible stalk 25cm
- Full extended overall length 128 cm
- Approved ECE R16, DIR 77/541, SAE J386 & FMVSS 302
- Buckle with integral micro switch (3 wire) IP 67 rated, switch black/blue = normal open, black/red= normal closed



ELR SEAT BELT



REF [147TA3654](#) – Orange webbing

REF [125TA6316](#) – Black webbing

Characteristics:

- ELR (Emergency Locking Retractor) mounts 60° forward of vertical on **left hand hip only**
- Twin release buckle on rigid bracket 15 cm
- Full extended overall length 128 cm
- Approved to ECE R16, SAE J386 & FMVSS 302





ELR SEAT BELT



REF [147TA3655](#) – Orange webbing

REF [145TA2803](#) – Black webbing

Characteristics:

- ELR (Emergency Locking Retractor) mounts 60° forward of vertical on **right hand hip only**
- Twin release buckle on rigid bracket 15 cm
- Full extended overall length 128 cm
- Approved to ECE R16, SAE J386 & FMVSS 302



ELR SEAT BELT



REF [144TA6916](#) – Orange webbing

REF [144TA6917](#) – Black webbing

Characteristics:

- ELR (Emergency Locking Retractor) mounts 60° forward of vertical on **left hand hip only**
- Twin release buckle on flexible stalk 25 cm
- Full extended overall length 128 cm
- Approved to ECE R16, SAE J386 & FMVSS 302





ELR SEAT BELT



REF [144TA6914](#) – Black webbing

Characteristics:

- ELR (Emergency Locking Retractor) mounts 60° forward of vertical on **left hand hip only**
- Top Release Buckle on Cranked rigid bracket 12 cm
- Full extended overall length 128 cm
- Approved to ECE R16, ISO6683, SAE J386 & FMVSS 209



ELR SEAT BELT



REF [147TA3656](#) – Black webbing

Characteristics:

- ELR (Emergency Locking Retractor) mounts 60° forward of vertical on **left hand hip only**
- Top Release Buckle on flexible stalk 25 cm
- Full extended overall length 128 cm
- Approved to ECE R16, ISO6683, SAE J386 & FMVSS 209





ELR SEAT BELT



REF 139TA5238 – Orange webbing

REF 126TA6067 – Black webbing

Characteristics:

- ELR (Emergency Locking Retractor) mounts 60° forward of vertical on **left hand hip only**
- Twin release buckle on rigid bracket 15 cm
- Full extended overall length 128 cm
- Approved to ECE R16, SAE J386 & FMVSS 302
- Buckle with integral micro switch (3 wire) IP 67 rated, switch black/blue = normal open, black/red= normal closed



ELR SEAT BELT



REF 147TA3657 – Orange webbing

REF 142TA1538 – Black webbing

Characteristics:

- ELR (Emergency Locking Retractor) mounts 60° forward of vertical on **left hand hip only**
- Top Release Buckle on Cranked rigid bracket 12 cm
- Full extended overall length 128 cm
- Approved to ECE R16, ISO6683, SAE J386 & FMVSS 209
- Buckle with integral micro switch (2 wire) IP 67 rated, normal open, mate-n-lock connector





ELR SEAT BELT



REF [147TA3658](#) – Orange webbing

REF [141TA4999](#) – Black webbing

Characteristics:

- ELR (Emergency Locking Retractor) mounts 60° forward of vertical on **right hand hip only**
- Top Release Buckle on Cranked rigid bracket 12 cm
- Full extended overall length 128 cm
- Approved to ECE R16, ISO6683, SAE J386 & FMVSS 209
- Buckle with integral micro switch (2 wire) IP 67 rated, normal open, mate-n-lock connector



MUR SEAT BELT



REF [129TA8647](#) – Black webbing

Characteristics:

- MUR (Manually Unlocking Retractor)
- Twin release buckle on rigid bracket 10 cm
- Full extended overall length 128 cm
- Approved SAE J386 and FMVSS 302





MUR SEAT BELT



REF [142TA3336](#) – Orange webbing

REF [139TA5789](#) – Black webbing

Characteristics:

- MUR (Manually Unlocking Retractor)
- Twin release buckle on flexible stalk 25 cm
- Full extended overall length 128 cm
- Approved SAE J386 and FMVSS 302



3-POINT SEAT BELT



REF [147TA3659](#) – Black webbing

Characteristics:

- 3 Point ELR (Emergency locking retractor) mounts vertically
- Full extended overall length 29 cm
- Twin release buckle on semi-rigid cable stalk 30 cm
- Approved ECE R16





3-POINT SEAT BELT



REF [136TA3233](#) – Orange webbing

Characteristics:

- 3 point ELR (Emergency Locking Retractor) mounts vertically
- Full extended overall length 29 cm
- Twin release buckle on rigid bracket 15 cm, webbing length 297 cm fully extended
- Approved ECE R16
- Buckle with integral micro switch (3 wire) IP 67 rated, switch black/blue = normal open, black/red= normal closed



SEAT BELT EXTENDER



REF [145TA1853](#) – Red webbing

Characteristics:

- Seat belt extender for use with Securon seat belts only
- Full extended overall length 50 cm





EZE BELT



REF [144TA6915](#)

Characteristics:

- The EZE belt is designed to encourage use of the provided operator safety belt
- Mounted on the grab handle



This is not a safety belt

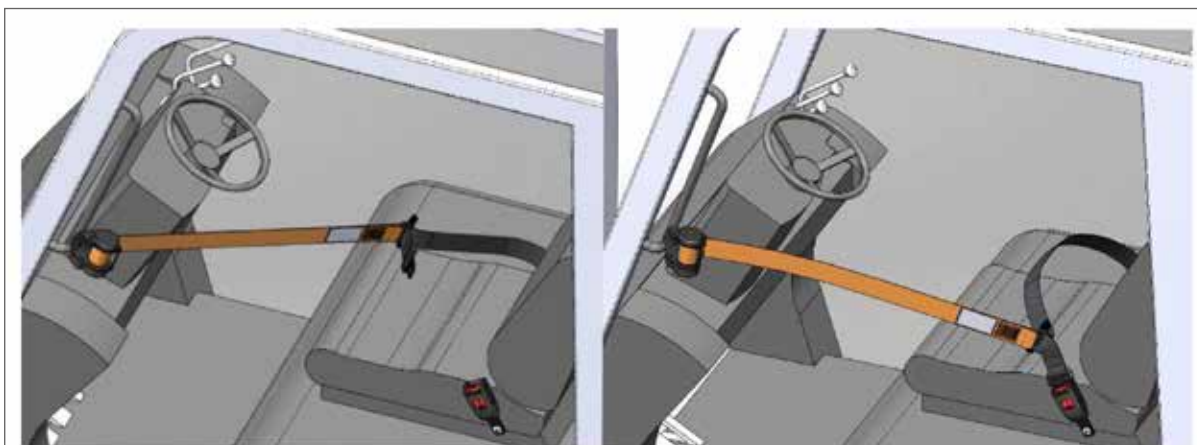

1. EZE Retractor holds safety belt tongue ready for operator. (N.B. if using an ALR safety belt, ALR webbing must be completely retracted before attempting to fasten safety belt).

2. With safety belt engaged around wearer, EZE retractor webbing stays taut and does not obstruct whilst manoeuvring the vehicle.



SPRINGBELT

REF 151TA2268 – Springbelt ALR orange electric

REF 151TA2269 – Springbelt ELR orange electric

Springbelt is a remarkable product that has been refined and developed over many years to protect both employees and employers. It's called Springbelt, because as you can see, it springs up when unbuckled making it a real nuisance and cannot be sat on as per a normal belt/buckle. When it's buckled, it holds the operator firmly, comfortably and safely in their seat. It can be fitted easily to all common types of mobile machinery providing highly visible workplace protection for you and your operators.





UNIVERSAL SEAT BELT BRACKET



REF [106TA5154](#)

- Easy to fit between seat and slide rails
- Overall length: 525 mm

SEAT BELT BRACKET



REF [147TA4100](#) - (1 pc)

Allows easy fitting of the belt (for MSG 20)

SEAT COVER



REF [106TA6749](#)

- Universal seat cover, with opening for head rest and documents
- Waterproof
- Length: 900 mm
- Width: 600 mm

DISPOSABLE SEAT COVER



REF [141TA1560](#)

- Roll of 100 pieces for easy dispensing
- Material: polyethylene
- Bio-degradable
- Dimensions: 800 x 1300 mm



SEAT COVER GRAMMER

REF [144TA6918](#)

- Fits the Maximo, Primo, Actimo, Compacto models
- ! Not suited for seats with climate control



SUMMER SEAT

REF [106TA8623](#)

- To fit on top of seat and back cushions
- Comfortable driving on hot summer days



UNIVERSAL SEAT HEATING

REF [106TA8620](#)

- To fit on top of seat and back cushions
- High and low heating function
- 12 V



UNIVERSAL SEAT HEATING

REF [147TA4101](#)

- To fit on top of seat and back cushions
- 12 V





SEAT HEATING

REF [106TA8617](#) – 12 V

REF [106TA8618](#) – 24 V

REF [106TA8619](#) – 48 V

- Heating pads to mount between seat foam and cover
- Can be used for some seats of: KAB, BEGE, ISRI



OPERATOR PRESENCE SWITCH

REF [106TA5151](#)

- Universal sensor pad
- Works as NO (normal open) contact



OPERATOR PRESENCE SWITCH

REF [106TA5153](#)

- Universal sensor pad
- Works as NO (normal open) contact



SEAT SWITCH

REF [110TA9013](#) – NO (normal open) contact





DOCUMENT HOLDER



REF 123TA7529

- OEM quality
- Waterproof
- For A4 documents
- Outer dimensions: 365 x 280 x 55 mm
- Inner dimensions: 320 x 220 x 30 mm
- Material: high-density polyethylene

DOCUMENT HOLDER



REF 131TA2735

- Economic version
- For A4 documents
- Outer dimensions: 320 x 260 x 55 mm
- Inner dimensions: 295 x 230 x 40 mm
- Material: high-density polyethylene

DOCUMENT HOLDER



REF 106TA6801

- Universal document holder
- Length: 350 mm
- Inner length: 325 mm
- Inner diameter: 70 mm
- Material: PVC
- Supplied with brackets



REF 116TA5758

- Steel bracket for document holder
- M8 – Thread fitting

DOCUMENT HOLDER



REF 107TA7951

- OEM quality
- Waterproof
- For A5 documents
- Outer dimensions: 295 x 195 x 45 mm
- Inner dimensions: 230 x 160 x 15 mm
- Material: high-density polyethylene

DOCUMENT HOLDER



REF 106TA8631

- For A4 documents
- Dimensions: 305 x 310 mm
- Thickness up to 15 mm

DOCUMENT NET



REF 107TA7950

- Set contains 2 equal halves
- Dimensions: 375 x 215 mm



DOCUMENT HOLDER



REF 131TA2736

- For Sears 1200-series seats
- Dimensions: 235 x 162 x 20 mm
- Material: plastic box with plexi cover

DOCUMENT HOLDER



REF 131TA2737

- For Sears seats
- Dimensions: 330 x 270 mm
- Thickness up to 50 mm
- Material: imitation leather

DOCUMENT HOLDER



REF 131TA2734

- Used for Clark
- For A5 documents
- Outer dimensions: 232 x 180 x 20 mm
- Inner dimensions: 214 x 166 x 17 mm
- Material: polyethylene
- Only for use inside cab due to open top

DOCUMENT HOLDER



REF 143TA6466

- Document holder with zipper
- Resistant to moisture, freezing temperatures and heat
- Dimensions: 310 x 220 mm

TWIGGY SEAL TO SECURE DOCUMENT HOLDERS



REF 140TA6051

- Dimensions lace: 2,2 x 255 mm
- Dimensions label: 22 x 45 mm
- Box of 100 pieces
- Red

STICKER



REF 107TA7976

Sticker seat belt



UNIVERSAL TURNTABLE



REF 111TA6202

- Fixed positions at 20°, 90°, 180°, 270° and 340°
- Dimensions upper part: 350 x 350 mm
- Dimensions lower part: 330 x 310 mm

GRAMMER TURNTABLE



REF 141TA5021

- 360°
- Dimensions upper part: 390 x 360 mm
- Dimensions lower part: 370 x 370 mm
- Height: 31 mm

GRAMMER TURNTABLE



REF 147TA3661

- 180°, lockable every 10°
- Dimensions upper part: 370 x 325 mm
- Dimensions lower part: 350 x 290 mm

FASTENED SEAT BELT INDICATOR



REF 128TA4257

- Bulb 12 V - REF 103TA4554
- Bulb 24 V - REF 103TA4556



NOTES

NOTES

A large area for notes, featuring a light gray background with a white curved shape at the bottom. The area is filled with horizontal dotted lines for writing.



4

CONSUMABLES



MULTI-ORGANIZER CONSOLE



REF 151TA3834

Toolbox with screws, pen and manual that includes the drilling pattern and expansion options

- Dimensions (L x B x H): 510 x 170 x 110 mm
- Power outlet: 12 V



MAG-KADDY

REF 151TA3835 - MAG-KADDY

- Organizes all the necessities of material handling: pens, pencils, markers, door openers, utility knives ...
- Dimensions (L x B x H): 142 x 102 x 84,5 mm
- Diameter of magnetic foot: 85,7 mm



REF 151TA3836 - MAGNUM MAG-KADDY

- Organizes larger necessities of material handling: hand tools, power tools, tape ...
- Dimensions (L x B x H): 240 x 195 x 138 mm



Both cab accessories have a patented design which allows them to be positioned where it's safe and convenient. They are constructed of tough ABS plastic. The bottom is perforated to prevent dirt build-up and to prevent holding water in outdoor applications. The super-strong magnet holds the accessories firmly onto their place, and allows installation in 1 second.

Ideal for use on:

- Forklifts
- Skid loaders
- Construction equipment
- Agricultural equipment
- ...





SOLAR CAP



Quality sun & debris canopy protection for all lifts

REF 151TA3837

- No more squinting while having an overhead load
- Custom tinted anti-sunglare material
- More coverage with the see-through visor
- Keep cool from overhead sun
- Fits all lifts
- Protection from sun, debris and rain
- Attaches to all lifts in seconds
- Dimensions: 1350 x 1150 mm

CANOPIES



REF 151TA3838

- Transparent plastic
- Dimensions: 1000 x 1000 mm

PVC WEATHERGUARD



Full enclosure for occasional use

Assembled and disassembled on forklift truck in only a couple of minutes.

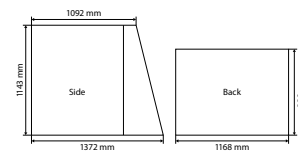

REF 151TA3839

Small type: up to 3 tonne

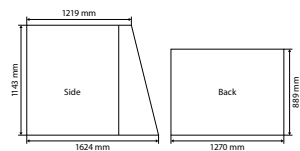

REF 151TA3840

Large type: up to 6 tonne

SUNSCREEN



REF 151TA3841

- PVC
- Dimensions: 480 x 150 mm

SUNSCREEN



REF 151TA3842

- Tinted glass
- Dimensions: 450 x 135 mm



17 PIECE 1/2" HEXAGON COMBINATION SET



REF 151TA3843

Contents:

- 12 hexagon sockets: 10 – 11 – 12 – 13 – 14 – 17 – 19 – 22 – 24 – 27 – 30 – 32 mm
- 1 x 72-teeth ratchet
- 1 sliding T-handle
- 2 extensions: 125 – 255 mm
- 1 universal joint



19 PIECE 1/2" SOCKET AND ACCESSORIES SET – METRIC



REF 151TA3844

Contents:

- 14 hexagon sockets: 10 – 11 – 12 – 13 – 14 – 15 – 16 – 17 – 19 – 22 – 24 – 27 – 30 – 32 mm
- 1 x 32-teeth ratchet
- 1 sliding T-handle
- 2 extensions: 125 – 250 mm
- 1 universal joint



24 PIECE 1/2" SOCKETS AND ACCESSORIES SET – INCH



REF 151TA3845

Contents:

- 18 surface drive sockets: 5/16" – 3/8" – 7/16" – 1/2" – 9/16" – 19/32" – 5/8" – 11/16" – 3/4" – 25/32" – 13/16" – 7/8" – 15/16" – 1" – 1 1/16" – 1 1/8" – 1 3/16" – 1 1/4"
- 1 x 24-teeth ratchet
- 1 sliding T-handle
- 1 swivel handle
- 2 extensions: 125 – 250 mm
- 1 universal joint





8 PIECE 'BETAGRIP' SCREWDRIVER SET

REF 151TA3846

1263/D8

Contents:

- 5 slotted screwdrivers:
 0,4 x 2,5 x 75 – 0,5 x 3 x 75 – 0,8 x 4 x 100 –
 1 x 5,5 x 125 – 1,2 x 6,5 x 150 mm
- 3 Phillips screwdrivers:
 PH0 x 3 x 60 – PH1 x 4,5 x 80 – PH2 x 6 x 100 mm



6 PIECE SLOTTED AND PHILLIPS ANTISLIP BI-COMPONENT HANDLE SCREWDRIVER SET

REF 151TA3847

Contents:

- 3 slotted screwdrivers:
 5,5 x 100 – 6,5 x 125 – 8 x 150 mm
- 3 Phillips screwdrivers:
 PH1 x 80 – PH2 x 100 – PH3 x 150 mm





DRY LUBE

REF 151TA3848

- Fast drying, white lubricant, containing PTFE
- Outstanding lubricity and anti-stick or release properties
- Most effective where low speeds and light loads are involved
- Spray: 500 ml



5-56 + PTFE UNIVERSAL OIL SPRAY

REF 151TA3849

- Multifunctional service fluid for use in the professional mechanic maintenance
- Repulses moisture and prevents electrical failure
- Provides a good protection against corrosion
- Cleans and protects surfaces contaminated by machining or handling
- Spray: 500 ml



GLASS CLEAN

REF 151TA3850

- Sparkling streak-free finish for all glass surfaces
- Quick and easy removal of tough dirt and grime including grease, finger prints, bugs and smoke haze
- Prevents misting when used on a regular basis
- Anti-static properties to keep surfaces dust-free
- Guaranteed safe on glass, tinted windows, Perspex, plexiglass, mirrors, marble benchtops
- Domestic and commercial use
- Spray: 400 ml



TEXTILE CLEANER

REF 151TA3851

- High-quality effective, fast-drying foam to clean
- Scent: citrus
- Appearance: white foam
- Spray: 600 ml





LEATHER CONDITIONER

REF 151TA3852

- High-quality maintenance product to clean and protect upholstery of leather and semi leather
- Spray: 600 ml



INSECT CLEANER

REF 151TA3853

- High quality, intensive cleaner to remove insects
- Spray: 500 ml



DE-ICER

REF 151TA3854

- A high-performance de-icer spray, suitable for use on vehicle windscreens. Contains antifreeze to help prevent refreezing
- Spray: 500 ml



COCKPIT SPRAY

REF 151TA3855

- Restores, protects and makes shiny all kinds of dashboards
- Stops dust resettling
- Anti-static effect
- Spray: 400 ml





SPONGE



REF 151TA3856

Dimensions: 115 x 114 x 60 mm

SYNTHETIC SHAMMY



REF 151TA3857

Dimensions: 38 x 36 mm

REUSABLE GLOVES FOR CHEMICAL INDUSTRY

REF 151TA3858 – Size: 7

REF 151TA3859 – Size: 8

REF 151TA3860 – Size: 9

REF 151TA3861 – Size: 10

Recommendations:

High-performance chemical protection (oils, detergents, certain solvents)

Applications:

- Degreasing of metals (solvents) in the automotive and aeronautic industry
- Machining of parts in the presence of cutting oils
- Manufacturing and application of paints and varnishes
- Cleaning of printing rolls

Advantages:

The nitrile formulation was chosen for its mechanical resistance, its flexibility, and its resistance to a great number of chemical products

Care instructions:

In order to keep its properties, this article should not be cleaned

Standard:

- Cat III
- EN 407
- EN 388:3101
- EN 374-3:JKL





FLEXIDYN PU

- REF 151TA3862** – Size: 7
- REF 151TA3863** – Size: 8
- REF 151TA3864** – Size: 9
- REF 151TA3865** – Size: 10
- REF 151TA3866** – Size: 11

Recommendations:

Handling sharp parts in a dry or greasy environment

Applications:

- Handling of paper, fine sheet metal, sheets of glass, plastic items, cutting tools and finishing operations with cutters (Dynaflex)
- Handling of damp and slippery objects such as steel rods and sheet metal

Advantages:

- Excellent protection against cuts
- Excellent dexterity
- The fresh touch of Dyneema® provides a feeling of comfort

Characteristics :

- Cat II
- EN 420
- EN 388: 4543



Honeywell

PERFECT FIT GLOVE POLYTRIL AIR COMFORT

- REF 151TA3867** – Size: 6
- REF 151TA3868** – Size: 7
- REF 151TA3869** – Size: 8
- REF 151TA3870** – Size: 9
- REF 151TA3871** – Size: 10
- REF 151TA3872** – Size: 11

Recommendations:

Light handling, assembling in oily environment. Handling in wet and greasy environment

Applications:

Assembly work, plumbing, joinery, construction, automotive industry, white and brown goods

Advantages:

- The gloves combine mechanical resistance and dexterity
- Excellent impermeable properties to oils

Standard:

- Cat II
- EN 420
- EN 388: 4121



Honeywell



NOTES

NOTES

A large area for notes, featuring a light gray background with a white curved shape at the bottom. The area is filled with horizontal dotted lines for writing.

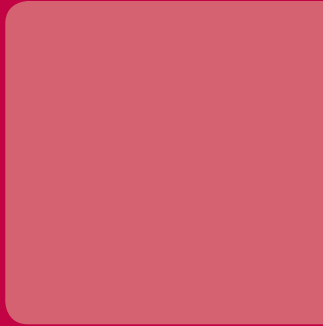
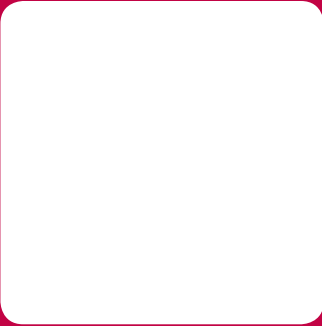
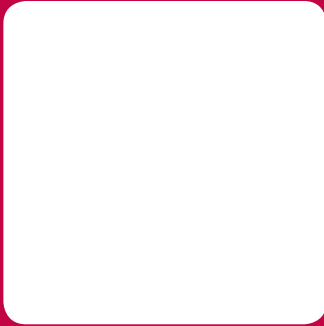
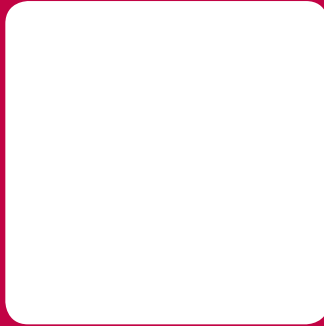
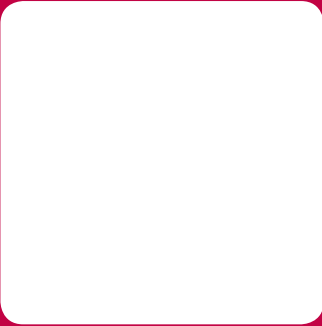

5

TECHNICAL SHEETS

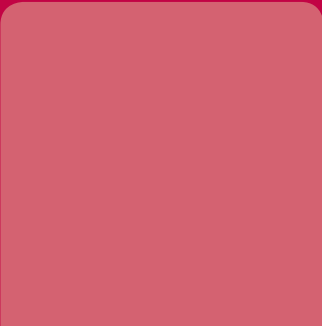



TECHNICAL SHEET

TECHNICAL SHEET SEAT

Group
08-02-01-00



Customer details

Type machine: Price inquiry
 Serial n° machine: Order

CODE:

BRAND x TY x MAT1 x SUSP x U1 x ADJ-G x G1 x G2 x CON-S x BELT x CON-B x FOL-B x
 HEAT x U2 x ADJ-FB x L1 x ARM-PR x TY-ARM x HEAD-R x DOC-H x HIP-R x ADJ-H x
 ADJ-B x ADJ-SA x LUM-PR x SCH-R x TLS x H1 x H2 x W1 x W2 x W3 x W4 x L2 x H3 x L3 x
 MAT2 x SLR-PR x G3 x COL



- BRAND Brand.
- TY Type.
- MAT1 Upholstery:
PVC
F = fabric
FLU = velvet
- SUSP Suspension:
L = air suspension
LC = air suspension with compressor
MP = mechanical position
MS = mechanical stepless
N = no
- U1 Compressor voltage, if suspension with compressor (V).
- ADJ-G Weight adjustment present: YES/NO.
- G1 Minimum weight (kg).
- G2 Maximum weight (kg).
- CON-S Seat contact:
C = contact plate
M = microswitch
N = no
OP = optional
Y = yes



TECHNICAL SHEET



- BELT** Belt:
ALR = automatic locking retractor
ELR = emergency locking retractor
ELRL = emergency locking retractor on left-hand side
ELRR = emergency locking retractor on right-hand side
MLR = manual locking retractor
S = static
N = no
OP = optional
- CON-B** Belt with contact: YES/NO.
- FOL-B** Foldable back: YES/NO.
- HEAT** Heating present:
Y = yes
N = no
OP = optional
- U2** Heater voltage (V).
- ADJ-FB** Adjustment front - back: YES/NO.
- L1** Adjustment distance front - back (mm)
- ARM-PR** Armrest present:
L = only left-hand side
R = only right-hand side
B = both sides
N = no
OP = optional
- TY-ARM** Type of armrest:
A = adjustable
S = static
- HEAD-R** Head rest present:
Y = yes
N = no
OP = optional
- DOC-H** Document holder present:
Y = yes
N = no
OP = optional
- HIP-R** Hip rest present:
Y = yes
N = no
OP = optional



TECHNICAL SHEET



- ADJ-H Height adjustment:
A = adjustable
S = stepless
P = position
N = no
OP = optional
- ADJ-B Back adjustment:
S = stepless
P = position
N = no
OP = optional
- ADJ-SA Seat angle adjustment:
S = stepless
P = position
N = no
OP = optional
- LUM-PR Lumbar support present:
Y = yes
N = no
OP = optional
- SCH-R Shoulder rest present:
Y = yes
N = no
OP = optional
- TLS Tilt-forward seat: YES/NO.
- H1 Maximum seat height (measured in rest condition) (mm).
- H2 Minimum seat height (measured in loaded condition) (mm).
- W1 Minimum distance between the slide rails (mm).
- W2 Maximum distance between the slide rails (mm).
- W3 Maximum width of the seat with parts and accessories (mm).
- W4 Maximum width of the seat without parts and accessories (mm).
- L2 Travel of the seat (mm).
- H3 Total height of the seat (mm).
- L3 Total length of the seat (mm).
- MAT2 Cushion stuffing:
FK = foam
MV = foam & springs



TECHNICAL SHEET



SLR-PR Slide rails present: YES/NO.

G3 Weight of the seat (kg).

COL Colour:

- B = black*
- BG = black grey*
- BL = blue*
- BR = brown*
- G = grey*
- GY = grey yellow*

DIMENSIONS

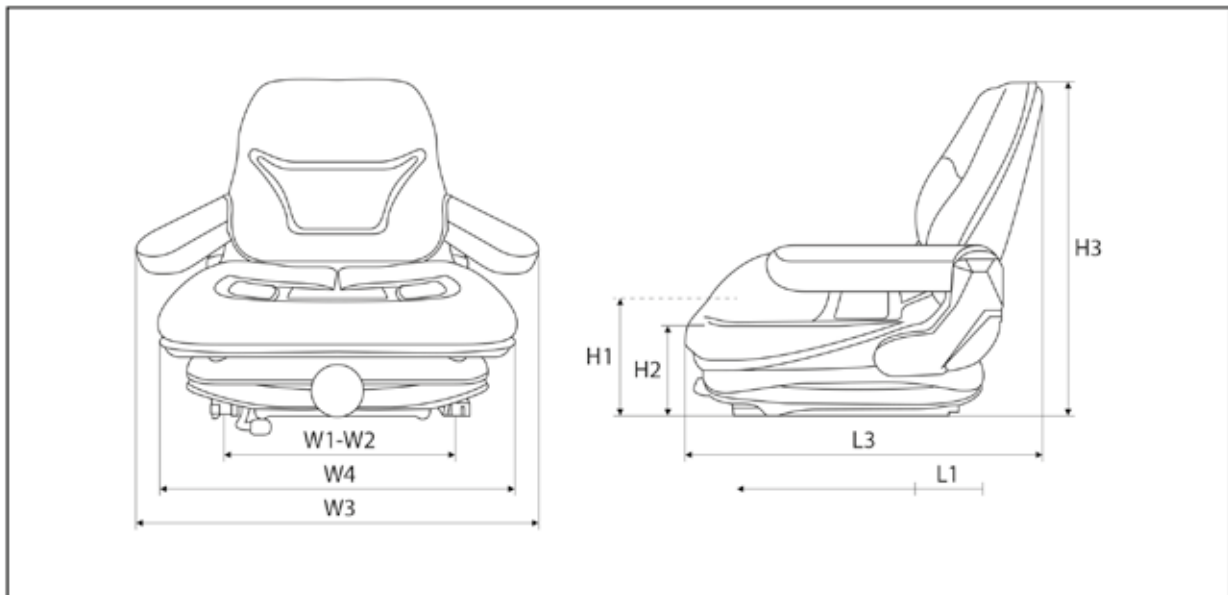

TLS: TILT-FORWARD SEAT

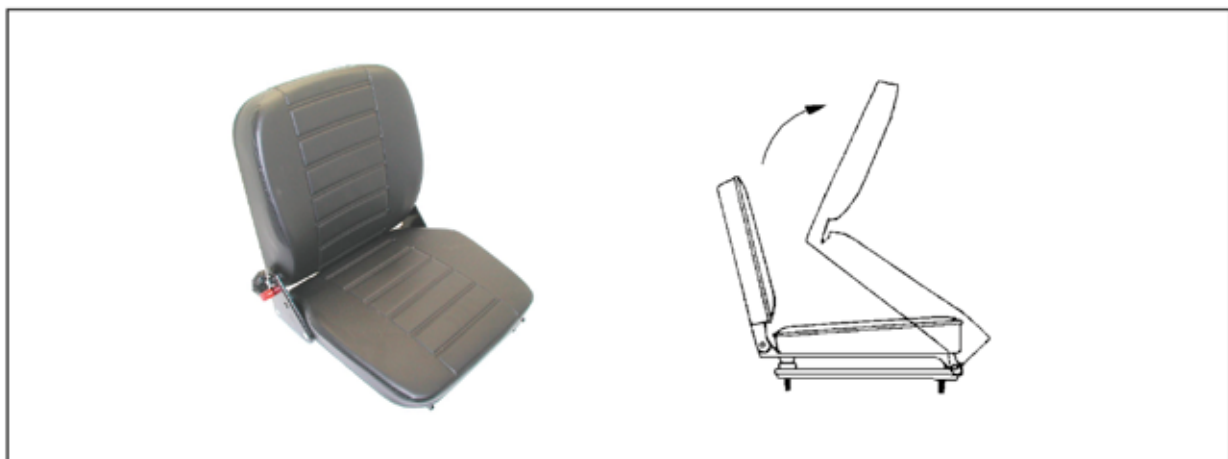



TECHNICAL SHEET

TECHNISCHE FICHE ZETEL

Groep
08-02-01-00



Gegevens klant

Type machine: Prijsaanvraag
 Serienr. machine: Bestelling

CODE: BRAND x TY x MAT1 x SUSP x U1 x ADJ-G x G1 x G2 x CON-S x BELT x CON-B x FOL-B x HEAT x U2 x ADJ-FB x L1 x ARM-PR x TY-ARM x HEAD-R x DOC-H x HIP-R x ADJ-H x ADJ-B x ADJ-SA x LUM-PR x SCH-R x TLS x H1 x H2 x W1 x W2 x W3 x W4 x L2 x H3 x L3 x MAT2 x SLR-PR x G3 x COL



- BRAND Merk.
- TY Type.
- MAT1 Bekleding:
 PVC
F = stof
FLU = fluweel
- SUSP Vering:
L = luchtvering
LC = luchtvering met compressor
MP = mechanisch positie
MS = mechanisch traploos
N = geen
- U1 Voltage van de compressor, indien type met compressor (V).
- ADJ-G Gewicht instelbaar: JA/NEE.
- G1 Minimum gewicht (kg).
- G2 Maximum gewicht (kg).
- CON-S Zetelcontact:
C = contactmat
M = microswitch
N = geen
OP = optioneel
Y = ja



TECHNICAL SHEET

- BELT Veiligheidsgordel:
ALR = oprolmechanisme met automatische vergrendeling
ELR = oprolmechanisme met noodvergrendeling
ELRL = oprolmechanisme met noodvergrendeling aan linkerkant
ELRR = oprolmechanisme met noodvergrendeling aan rechterkant
MLR = oprolmechanisme met manuele vergrendeling
S = statisch
N = geen
OP = optioneel
- CON-B Gordel met contact: JA/NEE.
- FOL-B Neerklapbare rugleuning: JA/NEE.
- HEAT Verwarming aanwezig:
Y = ja
N = nee
OP = optioneel
- U2 Voltage van de verwarming (V).
- ADJ-FB Verstelling voor - achter: JA/NEE.
- L1 Afstand van de verstelling voor - achter (mm).
- ARM-PR Armsteunen aanwezig:
L = enkel linkerkant
R = enkel rechterkant
B = beide kanten
N = nee
OP = optioneel
- TY-ARM Type armsteun:
A = verstelbaar
S = statisch
- HEAD-R Hoofdsteun aanwezig:
Y = ja
N = nee
OP = optioneel
- DOC-H Documentenhouder aanwezig:
Y = ja
N = nee
OP = optioneel
- HIP-R Heupsteun aanwezig:
Y = ja
N = nee
OP = optioneel



TECHNICAL SHEET



ADJ-H Hoogteverstelling:

A = verstelbaar

S = traploos

P = positie

N = nee

OP = optioneel

ADJ-B Rugverstelling:

S = traploos

P = positie

N = nee

OP = optioneel

ADJ-SA Zithoekverstelling:

S = traploos

P = positie

N = nee

OP = optioneel

LUM-PR Lendensteun aanwezig:

Y = ja

N = nee

OP = optioneel

SCH-R Schoudersteun aanwezig:

Y = ja

N = nee

OP = optioneel

TLS Voorwaarts kantelbare zetel: JA/NEE.

H1 Maximum zithoogte (gemeten in ruststand) (mm).

H2 Minimum zithoogte (gemeten in belaste toestand) (mm).

W1 Minimum afstand tussen de glijrails (mm).

W2 Maximum afstand tussen de glijrails (mm).

W3 Maximum breedte van de zetel met onderdelen en accessoires (mm).

W4 Maximum breedte van de zetel zonder onderdelen en accessoires (mm).

L2 Veerweg van de zetel (mm).

H3 Totale hoogte van de zetel (mm).

L3 Totale diepte van de zetel (mm).

MAT2 Kussens:

FK = schuimrubber

MV = schuimrubber & veren



TECHNICAL SHEET



SLR-PR Glijrails aanwezig: JA/NEE.

G3 Gewicht van de zetel (kg).

COL Kleur:

- B = zwart*
- BG = zwart grijs*
- BL = blauw*
- BR = bruin*
- G = grijs*
- GY = grijs geel*

AFMETINGEN

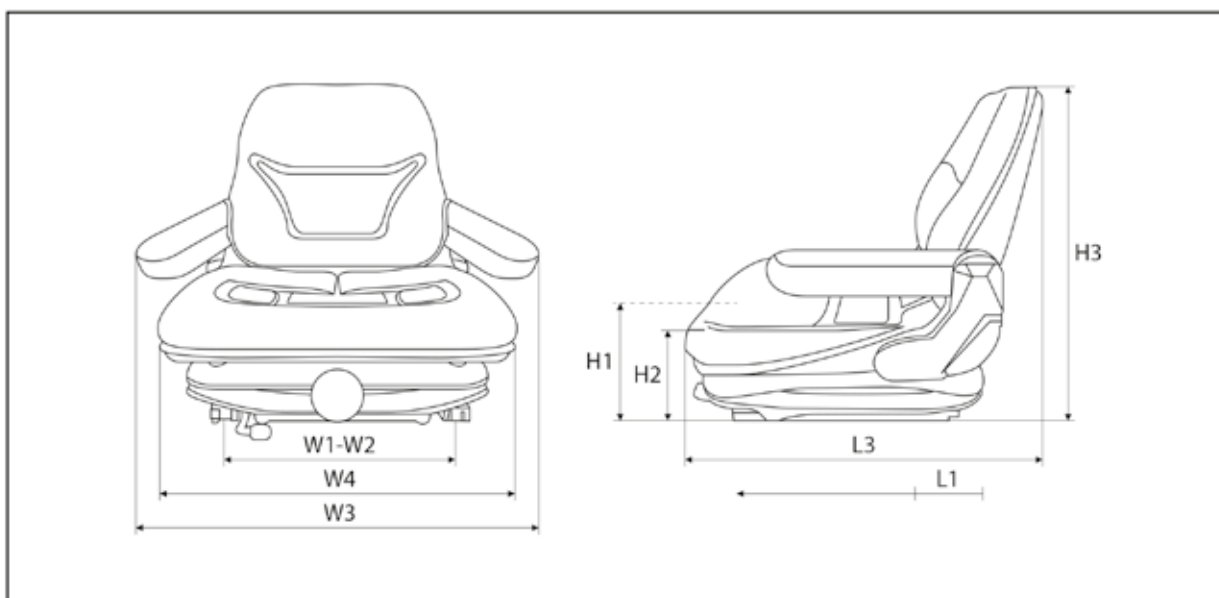

TLS: VOORWAARTS KANTELBARE ZETEL

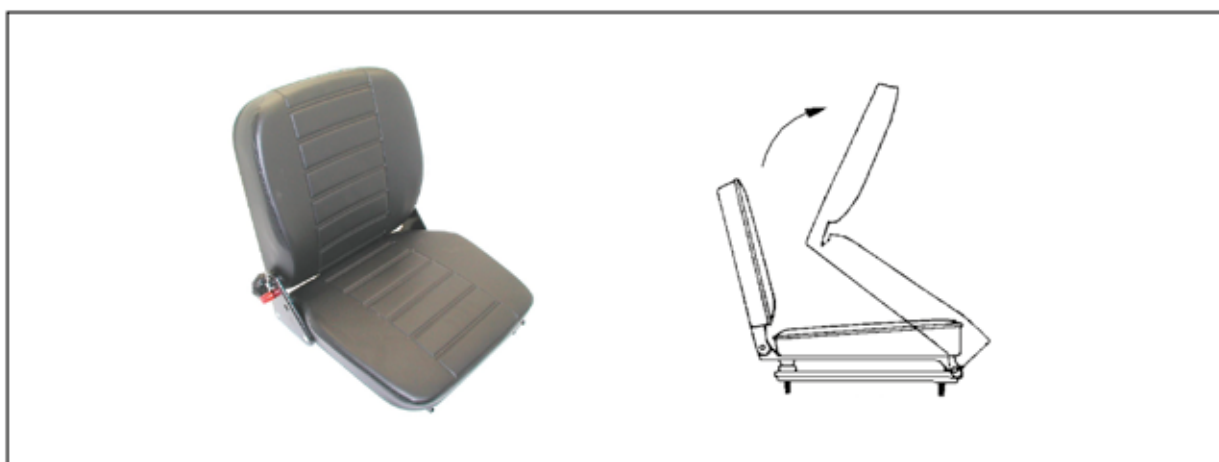



TECHNICAL SHEET

FICHE TECHNIQUE SIÈGE

Groupe
08-02-01-00

Exemple



Données client

Type machine : Demande de prix
 No. série machine : Commande

CODE : BRAND x TY x MAT1 x SUSP x U1 x ADJ-G x G1 x G2 x CON-S x BELT x CON-B x FOL-B x
 HEAT x U2 x ADJ-FB x L1 x ARM-PR x TY-ARM x HEAD-R x DOC-H x HIP-R x ADJ-H x
 ADJ-B x ADJ-SA x LUM-PR x SCH-R x TLS x H1 x H2 x W1 x W2 x W3 x W4 x L2 x H3 x L3 x
 MAT2 x SLR-PR x G3 x COL

- BRAND Marque.
- TY Type.
- MAT1 Revêtement :
 PVC
 F = tissu
 FLU = velours
- SUSP Suspension :
 L = suspension pneumatique
 LC = suspension pneumatique avec compresseur
 MP = position mécanique
 MS = en continu mécanique
 N = sans
- U1 Tension du compresseur, si type avec compresseur (V).
- ADJ-G Réglage du poids présent : OUI/NON.
- G1 Poids minimal (kg).
- G2 Poids maximal (kg).
- CON-S Contacteur :
 C = plaque de contact
 M = microcontact
 N = sans
 OP = optionnel
 Y = oui



TECHNICAL SHEET

- BELT Ceinture de sécurité :
- ALR = enrouleur avec verrouillage automatique*
 - ELR = enrouleur avec verrouillage d'urgence*
 - ELRL = enrouleur avec verrouillage d'urgence à gauche*
 - ELRR = enrouleur avec verrouillage d'urgence à droite*
 - MLR = enrouleur avec verrouillage manuel*
 - S = statique*
 - N = sans*
 - OP = optionnel*
- CON-B Ceinture avec contact : OUI/NON.
- FOL-B Dossier rabattable : OUI/NON.
- HEAT Chauffage présent :
- Y = oui*
 - N = non*
 - OP = optionnel*
- U2 Tension du chauffage (V).
- ADJ-FB Réglage avant - arrière : OUI/NON.
- L1 Distance du réglage avant - arrière (mm).
- ARM-PR Accoudoirs présents :
- L = seulement côté gauche*
 - R = seulement côté droit*
 - B = les deux côtés*
 - N = sans*
 - OP = optionnel*
- TY-ARM Type d'accoudoir :
- A = réglable*
 - S = statique*
- HEAD-R Appuie-tête présent :
- Y = oui*
 - N = non*
 - OP = optionnel*
- DOC-H Porte-document présent :
- Y = oui*
 - N = non*
 - OP = optionnel*
- HIP-R Maintien des hanches présent :
- Y = oui*
 - N = non*
 - OP = optionnel*



TECHNICAL SHEET

	<p>ADJ-H..... Réglage de la hauteur : <i>A = réglable</i> <i>S = en continu</i> <i>P = position</i> <i>N = non</i> <i>OP = optionnel</i></p> <p>ADJ-B Réglage du dossier : <i>S = en continu</i> <i>P = position</i> <i>N = non</i> <i>OP = optionnel</i></p> <p>ADJ-SA..... Angle d'assise réglable : <i>S = en continu</i> <i>P = position</i> <i>N = non</i> <i>OP = optionnel</i></p> <p>LUM-PR Réglage lombaire présent : <i>Y = oui</i> <i>N = non</i> <i>OP = optionnel</i></p> <p>SCH-R Maintien des épaules présent : <i>Y = oui</i> <i>N = non</i> <i>OP = optionnel</i></p> <p>TLS..... Siège basculant en avant : OUI/NON.</p> <p>H1 Hauteur d'assise maximale (mesurée en position de repos) (mm).</p> <p>H2 Hauteur d'assise minimale (mesurée en état chargé) (mm).</p> <p>W1 Distance minimale des glissières (mm).</p> <p>W2 Distance maximale des glissières (mm).</p> <p>W3 Largeur maximale du siège avec pièces et accessoires (mm).</p> <p>W4 Largeur maximale du siège sans pièces et accessoires (mm).</p> <p>L2 Course de suspension (mm).</p> <p>H3 Hauteur totale du siège (mm).</p> <p>L3 Profondeur totale du siège (mm).</p> <p>MAT2 Rembourrage du coussin : <i>FK = caoutchouc mousse</i> <i>MV = caoutchouc mousse & ressorts</i></p>
--	---



TECHNICAL SHEET



SLR-PR Glissières présentes : OUI/NON.

G3 Poids du siège (kg).

COL Couleur :
B = noir
BG = noir gris
BL = bleu
BR = brun
G = gris
GY = gris jaune

DIMENSIONS

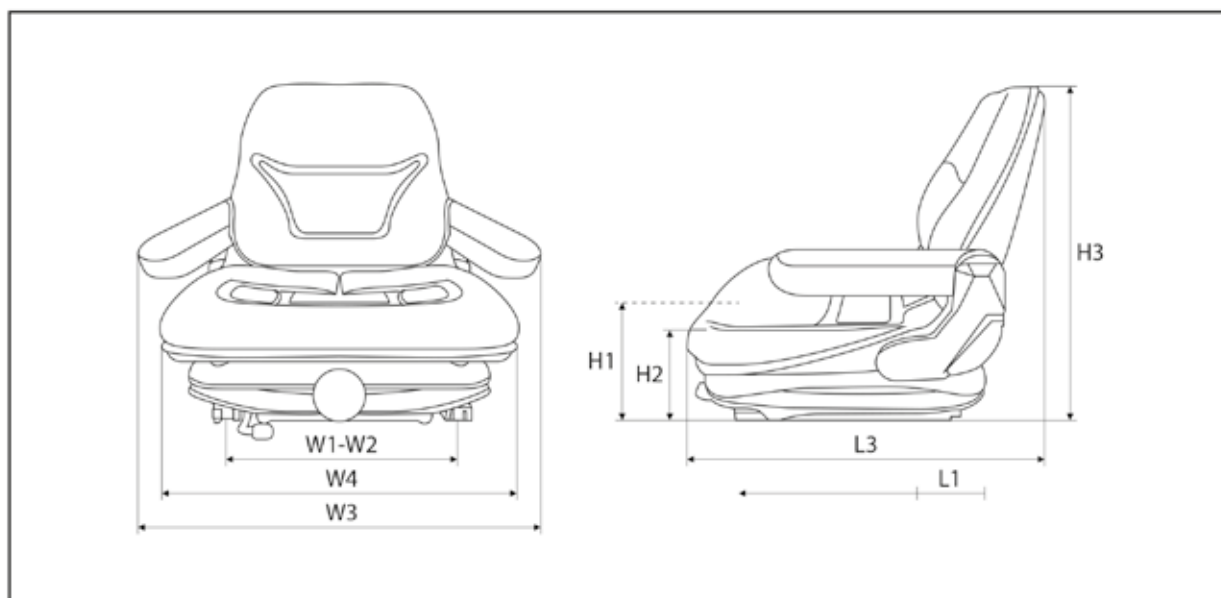

TLS : SIÈGE BASCULANT EN AVANT

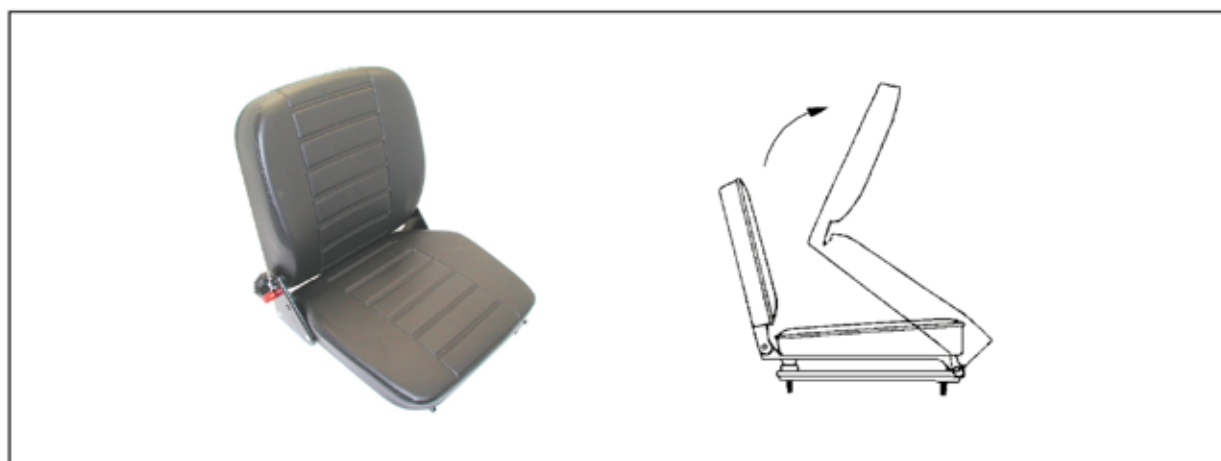



TECHNICAL SHEET

TECHNISCHES DATENBLATT SITZ

Gruppe
08-02-01-00



Kundendaten

Maschinentyp: Preisanfrage
 Serien-Nr. Maschine: Bestellung

CODE: BRAND x TY x MAT1 x SUSP x U1 x ADJ-G x G1 x G2 x CON-S x BELT x CON-B x FOL-B x HEAT x U2 x ADJ-FB x L1 x ARM-PR x TY-ARM x HEAD-R x DOC-H x HIP-R x ADJ-H x ADJ-B x ADJ-SA x LUM-PR x SCH-R x TLS x H1 x H2 x W1 x W2 x W3 x W4 x L2 x H3 x L3 x MAT2 x SLR-PR x G3 x COL



- BRAND Marke.
- TY Typ.
- MAT1 Polsterung:
 - PVC
 - F = Stoff
 - FLU = Samt
- SUSP Federung:
 - L = Luftfederung
 - LC = Luftfederung mit Kompressor
 - MP = mechanische Position
 - MS = mechanisch stufenlos
 - N = Nein
- U1 Spannung Kompressor, falls Federung mit Kompressor (V).
- ADJ-G Gewichtsverstellung: JA/NEIN.
- G1 Minimale Tragfähigkeit (kg).
- G2 Maximale Tragfähigkeit (kg).
- CON-S Sitzschalter:
 - C = Kontaktplatte
 - M = Mikroschalter
 - N = Nein
 - OP = optional
 - Y = Ja



TECHNICAL SHEET

- BELT** Sicherheitsgurt:
ALR = automatischer Retraktor mit Verriegelung
ELR = Retraktor mit Notverriegelung
ELRL = Retraktor mit Notverriegelung auf der linken Seite
ELRR = Retraktor mit Notverriegelung auf der rechten Seite
MLR = manueller Retraktor mit Verriegelung
S = fest
N = Nein
OP = optional
- CON-B** Sicherheitsgurt mit Kontakt: JA/NEIN.
- FOL-B** Klappbare Rückenlehne: JA/NEIN.
- HEAT** Sitzheizung:
Y = Ja
N = Nein
OP = optional
- U2** Spannung der Sitzheizung (V).
- ADJ-FB** Vorwärts-/Rückwärtsverstellung: JA/NEIN.
- L1** Wie weit verstellbar vorwärts/rückwärts (mm)
- ARM-PR** Armlehne vorhanden:
L = nur links
R = nur rechts
B = beidseitig
N = Nein
OP = optional
- TY-ARM** Art der Armlehne:
A = verstellbar
S = statisch
- HEAD-R** Kopfstütze vorhanden:
Y = Ja
N = Nein
OP = optional
- DOC-H** Dokumentenhalter vorhanden:
Y = Ja
N = Nein
OP = optional
- HIP-R** Hüftstütze vorhanden:
Y = Ja
N = Nein
OP = optional



TECHNICAL SHEET

- ADJ-H Höhenverstellung:
A = verstellbar
S = stufenlos
P = Position
N = Nein
OP = optional
- ADJ-B Rückenlehnenverstellung:
S = stufenlos
P = Position
N = Nein
OP = optional
- ADJ-SA Sitzwinkelverstellung:
S = stufenlos
P = Position
N = Nein
OP = optional
- LUM-PR Lendensätze vorhanden:
Y = Ja
N = Nein
OP = optional
- SCH-R Schulterstütze vorhanden:
Y = Ja
N = Nein
OP = optional
- TLS..... Vorwärts neigender Sitz: JA/NEIN.
- H1 Maximale Sitzhöhe (gemessen in Ruheposition) (mm).
- H2 Minimale Sitzhöhe (gemessen in Belastungszustand) (mm).
- W1 Mindestabstand der Gleitschienen (mm).
- W2..... Maximaler Abstand der Gleitschienen (mm).
- W3..... Maximale Breite des Sitzes mit allen Teilen und Zubehör (mm).
- W4..... Maximale Breite des Sitzes ohne Teile und Zubehör (mm).
- L2..... Federweg des Sitzes (mm).
- H3 Gesamthöhe des Sitzes (mm).
- L3..... Gesamtlänge des Sitzes (mm).
- MAT2 Füllung:
FK = Schaumstoff
MV = Schaumstoff & Federn

TECHNICAL SHEET



SLR-PR Gleitschiene vorhanden: JA/NEIN.

G3 Gewicht des Sitzes (kg).

COL Farbe:

B = Schwarz

BG = Schwarzgrau

BL = Blau

BR = Braun

G = Grau

GY = Gelbgrau

ABMESSUNGEN

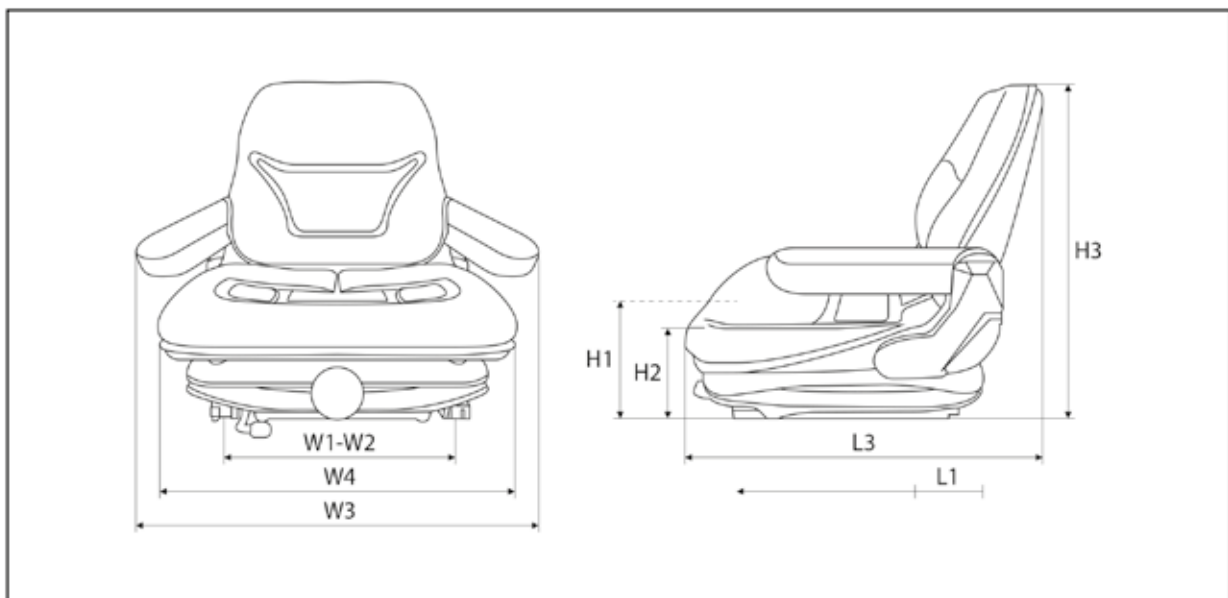

TLS: VORWÄRTS NEIGENDER SITZ

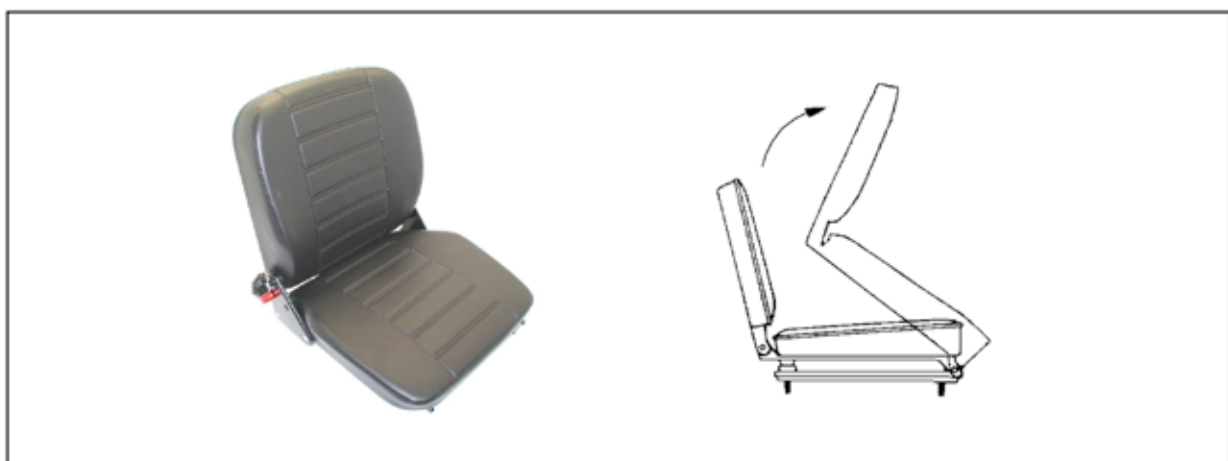



NOTES

NOTES

A large area for taking notes, featuring horizontal dotted lines on a light gray background. The background has a white curved shape at the bottom.



NOTES

NOTES

A series of horizontal dotted lines for writing notes, partially obscured by a large grey curved graphic on the left side of the page.



NOTES

NOTES

A large area for taking notes, featuring horizontal dotted lines. The page is decorated with a light gray curved background element that spans across the middle and bottom sections.



TVH PARTS AROUND THE WORLD

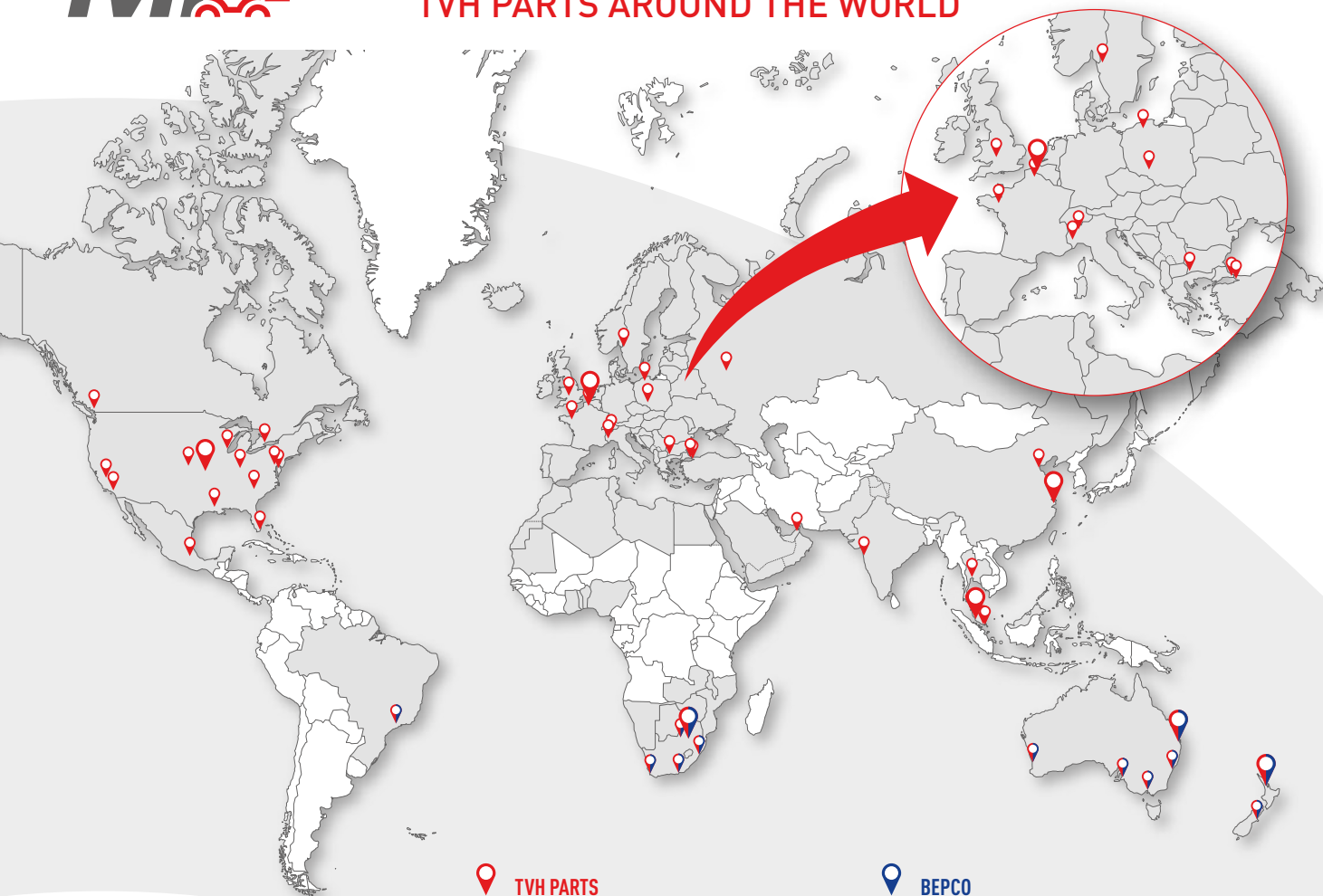

TVH PARTS

BEPCO

AUSTRALIA
TVH AUSTRALASIA PTY LTD
Dandenong South (Melbourne, Victoria) -
Richlands (Brisbane, Queensland) -
Welshpool (Perth, West Australia) -
Wetherill Park (Sydney, New South Wales) -
Wingfield (Adelaide, South Australia)

BELGIUM
TVH PARTS NV
Waregem
TVH GROUP NV
Waregem

BRASIL
TVH DINAMICA PEÇAS LTDA
Vinhedo

BULGARIA
TVH BULGARIA LTD
Petrich

CANADA
TVH CANADA LTD
Mississauga (Ontario) - Port Coquitlam (British Columbia)

CHINA
TVH TRADING (SHANGHAI) CO, LTD
Shanghai - Tianjin

FRANCE
TVH FRANCE SASU
Wattrelos
FRANCE HAYON GROUPE
Châteaubourg

INDIA
TVH INDIA PTE LTD
Pune

ITALY
TVH ITALIA SRL
Marano Ticino (Novara) - Torino
CAM SRL
Marano Ticino (Novara)

MALAYSIA
TVH MALAYSIA SDN BHD
Johor Bahru - Penang - Shah Alam (Kuala Lumpur)

MEXICO
TVH MEXICO, S DE RL DE CV
Cuautitlán Izcalli (Mexico City) - Monterrey

NEW ZEALAND
TVH NEW ZEALAND LTD
Christchurch - East Tamaki (Auckland)

POLAND
TVH POLSKA SP ZOO
Tychy

RUSSIA
TVH RUS LLC
Dubrovka (Moscow)

SINGAPORE
TVH SINGAPORE PTE LTD
Jurong

SOUTH AFRICA
TVH PARTS SOUTH AFRICA LTD
Briardene (Durban) - Isando (Johannesburg) -
Korsten (Port Elizabeth) - Kraaifontein (Cape Town) - Lichtenburg

SWEDEN
TVH NORDIC AB
Ed

THAILAND
TVH THAILAND LTD
Bangkok

TURKEY
TVH YEDEK PARCA TICARET AŞ
Başakşehir (Istanbul, European) - Tuzla (Istanbul, Asian)

UNITED ARAB EMIRATES
TVH MIDDLE EAST FZE
Sharjah

UNITED KINGDOM
TVH UK LTD
Coventry

USA
TVH PARTS CO
Duncan (South Carolina) - Fresno (California) - Graylake (Illinois) -
Harrisburg (Pennsylvania) - Miami (Florida) - Mira Loma (California) -
Olathe (Kansas) - Shreveport (Louisiana)
C-TECH
West Chester Township (Ohio)
SUPERIOR SIGNALS, INC
Olathe (Kansas)

SALES REPRESENTATION IN THE FOLLOWING COUNTRIES:

Albania, Algeria, Austria, Bahrain, Belarus, Benin, Bosnia, Botswana, Bulgaria, Canary Islands, Croatia, Cyprus, Denmark, Djibouti, Egypt, Estonia, Finland, Ghana, Greece, Hong Kong, Iceland, Ireland, Kosovo, Kuwait, Latvia, Lesotho, Libya, Lithuania, Macedonia, Malawi, Malta, Morocco, Mauritania, Moldova Republic, Montenegro, Mozambique, Namibia, Nigeria, Oman, Pakistan, Portugal, Qatar, Saudi Arabia, Serbia, Slovenia, Swaziland, Switzerland, Taiwan, Togo, Tunisia, Ukraine, Yemen, Zambia, Zimbabwe.



WE SPEAK YOUR
LANGUAGE
info@tvh.com

- More than 100 000 m² of warehousing
- Computer-controlled stock management
- More than 600 000 stock items
- More than 21 000 000 known references
- Technically skilled employees
- Same-day shipment, next-day delivery
- Webshop and online support
- One-stop shop

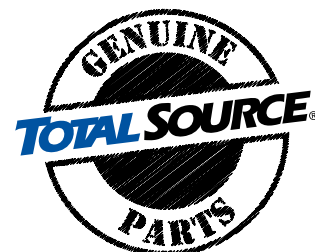

...Not cheap parts but
quality parts cheaper...



FOLLOW US



PARTS & ACCESSORIES



COMPANY MOVIE

Go to **downloads** on **www.tvh.com** to find all catalogues.



TVH PARTS NV
Brabantstraat 15 · 8790 Waregem · Belgium
T +32 56 43 42 11 · F +32 56 43 44 88 · info@tvh.com · www.tvh.com

TVH PARTS